



Smart Hospitality Display HQ60B Series (EU)

43 50 55 65 75

HIGHLIGHTS

- Quick access to leading streaming services
- Quantum Dot technology for brilliant color at any brightness
- Slim design that complements any interior while saving space
- Centralized management of hotel displays worldwide
- Optimize promotions and offers using personalized guest insights

Key features

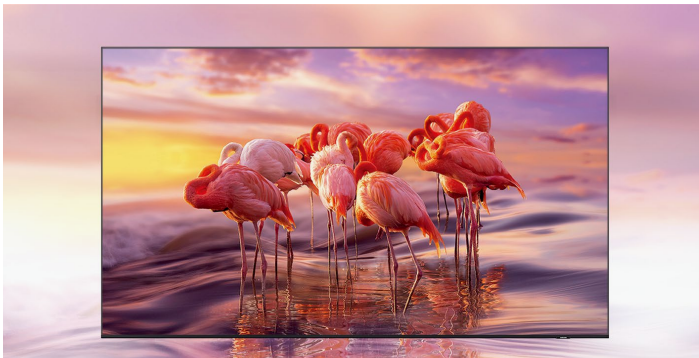

A billion shades of color with Quantum Dot

Quantum Dot technology delivers our finest picture ever. With 100% Color Volume, Quantum Dot takes light and turns it into breathtaking color that stays true at any level of brightness.

*100% color volume measured in Movie Mode and the DCI-P3 color space, certified by VDE.

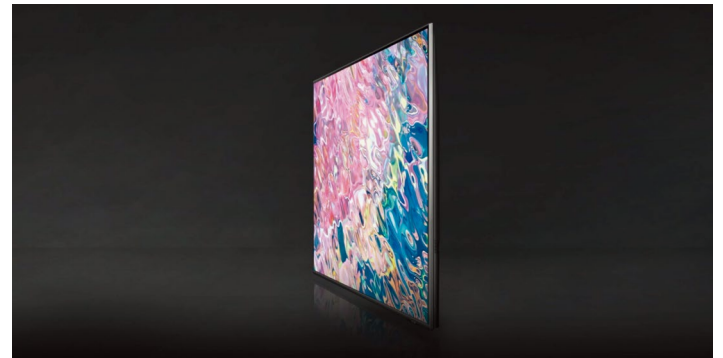

Sleek and slim, more than ever

Increase flexibility with ultra-slim design, enabling hotel operators to create optimized room layouts that increase guest comfort.



Object Tracking Sound Lite (OTS Lite)

A 3D surround sound with our virtual top channel audio will allow any room, small or large, to be fully immersed in the audio experience.



Centralize content discovery and promotions

Smart Hub offers guests easy access to a variety of custom content. Guests can enjoy their favorite Netflix movies and shows from their hotel room just like at home. Furthermore, managers can add the latest hotel promotions to the home screen for natural integration into the room environment.

Key features



Give guests access to their favorite content in beautiful QLED 4K

Modern guests are seeking the same home amenities and comforts while choosing their next hotel. To deliver a personalized touch during guest trips, hotels are adapting new technologies to win new customers. Samsung, the industry-leading TV brand, delivers the comforts of home with the new HQ60B series hospitality display. Featuring access to the most popular streaming services, including Netflix, in beautiful QLED 4K quality, guests are treated to the same conveniences of their living room while traveling worldwide.

Hospitality Solution

LYNK Cloud

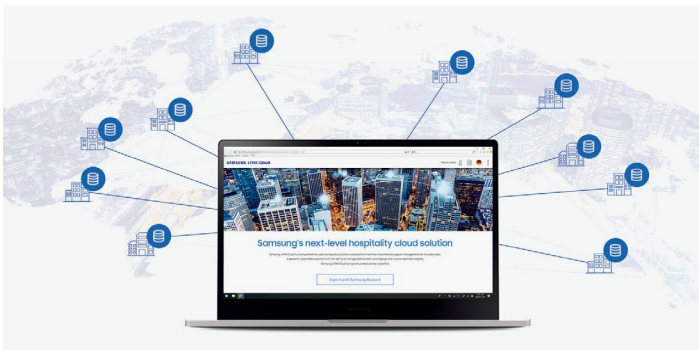

Streamlined property management

With online access that supports multiple users, Samsung LYNK Cloud is ideal for global hospitality operations with centralized management, giving users control of their hotel displays worldwide.

* LYNK Cloud License must be purchased separately.
* LYNK Cloud does not support management of properties within China.

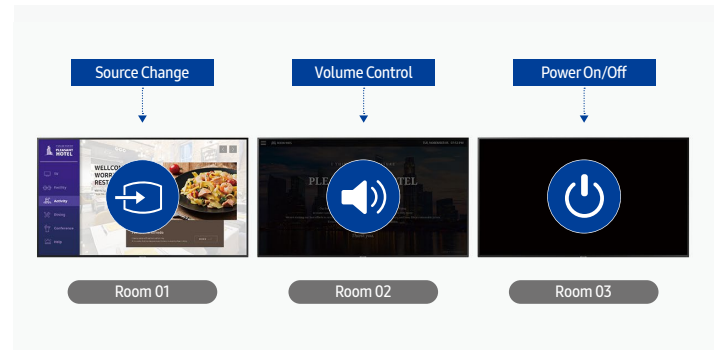

Integrated device management

Quickly update in-room TVs from a centralized source with Samsung LYNK Cloud. Managers can modify channel maps and program guides and control basic functions, making it easier than ever to provide support and maintenance.

* Some features may not be compatible with hotel's current platforms.

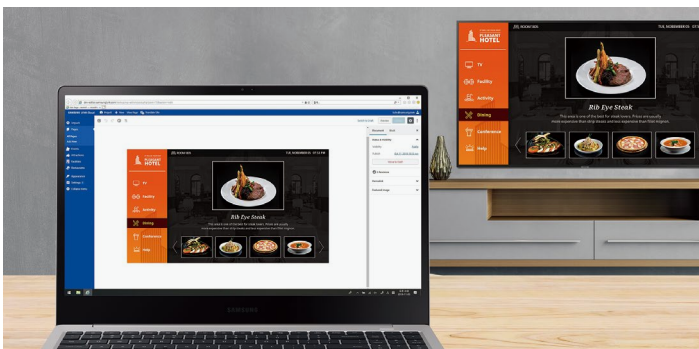

Content creation and custom interactions

Curate your hotel's in-room experience with LYNK Cloud. Create and remotely deploy web-based content to each in-room TV for a tailored feel to your property. With interactive requests support, you can provide the easiest way for guests to make room service orders and book spa appointments.

* Some features may not be compatible with hotel's current platforms.

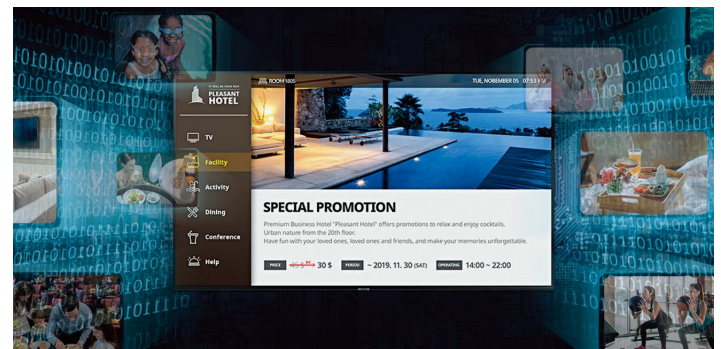

Data-driven promotional planning

Samsung LYNK Cloud enables optimized promotional content delivery based on integrated guest data available through the hotel PMS, helping managers to uncover business insights.

Specifications

Model Code		HG43Q60BAEAXEN	HG50Q60BAEAXEN	HG55Q60BAEAXEN	HG65Q60BAEAXEN	HG75Q60BAEAX
Display	Product	QLED	QLED	QLED	QLED	QLED
	Screen Size	43	50	55	65	75
	Resolution	3,840 x 2,160	3,840 x 2,160	3,840 x 2,160	3,840 x 2,160	3,840 x 2,160
Video	Picture Engine	Quantum Processor Lite	Quantum Processor Lite	Quantum Processor Lite	Quantum Processor Lite	Quantum Processor Lite
	Micro Dimming	Supreme UHD Dimming	Supreme UHD Dimming	Supreme UHD Dimming	Supreme UHD Dimming	Supreme UHD Dimming
	Auto Motion Plus	Yes	Yes	Yes	Yes	Yes
	Clear Motion	LED Clear Motion	LED Clear Motion	LED Clear Motion	LED Clear Motion	LED Clear Motion
	Film Mode	Yes	Yes	Yes	Yes	Yes
	PQI (Picture Quality Index)	3100	3100	3100	3100	3100
	HDR(High Dynamic Range)	Quantum HDR	Quantum HDR	Quantum HDR	Quantum HDR	Quantum HDR
	HDR10+	Certified(HDR10+ Adaptive)	Certified(HDR10+ Adaptive)	Certified(HDR10+ Adaptive)	Certified(HDR10+ Adaptive)	Certified(HDR10+ Adaptive)
	HLG (Hybrid Log Gamma)	Yes	Yes	Yes	Yes	Yes
	Contrast	Dual LED	Dual LED	Dual LED	Dual LED	Dual LED
	Color	100% Colour Volume with Quantum Dot	100% Colour Volume with Quantum Dot	100% Colour Volume with Quantum Dot	100% Colour Volume with Quantum Dot	100% Colour Volume with Quantum Dot
Viewing Angle (H/V)	178/178	178/178	178/178	178/178	178/178	
Contrast Enhancer	Yes	Yes	Yes	Yes	Yes	
Dolby Decoder	MS12 2ch	MS12 2ch	MS12 2ch	MS12 2ch	MS12 2ch	
Audio	Object Tracking Sound	OTS Lite	OTS Lite	OTS Lite	OTS Lite	OTS Lite
	Sound Output (RMS)	20W	20W	20W	20W	20W
	Speaker Type	2CH	2CH	2CH	2CH	2CH
	Woofer	N/A	N/A	N/A	N/A	N/A
	Bluetooth Audio	Yes	Yes	Yes	Yes	Yes
	VESA Mount	200 x 200 mm	200 x 200 mm	200 x 200 mm	400 x 300 mm	400 x 400 mm
VESA	VESA Screw Size	M8	M8	M8	M8	M8
	VESA Screw Depth	11-13	11-13	11-13	11-13	11-13
	Mobile to TV - Mirroring, DLNA	Yes	Yes	Yes	Yes	Yes
General Feature	Ambient Mode	Ambient Mode	Ambient Mode	Ambient Mode	Ambient Mode	Ambient Mode
	WiFi Direct	Yes	Yes	Yes	Yes	Yes
	Sound Mirroring	Yes	Yes	Yes	Yes	Yes
	Voice Guide	UK English, Finnish, France French, German, Greek, Hungarian, Italian, Norwegian, Polish, Portugal Portuguese, Romanian, Slovak, Spain Spanish, Swedish, Czech, Danish, Dutch, Korean				
	Auto Channel Search	Yes	Yes	Yes	Yes	Yes
	Auto Power Off	Yes	Yes	Yes	Yes	Yes
System	Caption (Subtitle)	Yes	Yes	Yes	Yes	Yes
	Connect Share™ (HDD)	Yes	Yes	Yes	Yes	Yes
	ConnectShare™ (USB 2.0)	Yes	Yes	Yes	Yes	Yes
	EPG	Yes	Yes	Yes	Yes	Yes
	OSD Language		27 European Languages + Russian(only when connecting to Network in EE, LV, LT)			
	BT HID Support	Yes	Yes	Yes	Yes	Yes
	USB HID Support	Yes	Yes	Yes	Yes	Yes
	Teletext (TTX)	Yes	Yes	Yes	Yes	Yes
	MBR Support	Yes	Yes	Yes	Yes	Yes
	IPv6 Support	Yes	Yes	Yes	Yes	Yes
	Digital Broadcasting	DVB-T2CS2	DVB-T2CS2	DVB-T2CS2	DVB-T2CS2	DVB-T2CS2
Hospitality Feature	Analog Tuner	Yes	Yes	Yes	Yes	Yes
	CI (Common Interface) Data Broadcasting	CI+(1.4) / CI+(1.4 ECP)_IT only	CI+(1.4) / CI+(1.4 ECP)_IT only	CI+(1.4) / CI+(1.4 ECP)_IT only	CI+(1.4) / CI+(1.4 ECP)_IT only	CI+(1.4) / CI+(1.4 ECP)_IT only
	H.Browser Compatibility	N/A	N/A	N/A	N/A	N/A
	Samsung LYNK™ REACH (IP)	N/A	N/A	N/A	N/A	N/A
	Samsung LYNK™ REACH (RF)	N/A	N/A	N/A	N/A	N/A
	Samsung LYNK™ Cloud	Yes	Yes	Yes	Yes	Yes
	Hospitality Plug&Play (Easy Set-up)	Yes	Yes	Yes	Yes	Yes
	Power On Mode	Yes	Yes	Yes	Yes	Yes
	Hotel Channel List	Yes	Yes	Yes	Yes	Yes
	Channel Menu Display	Yes	Yes	Yes	Yes	Yes
	Mixed Channel List (ATSC, DVB-T/T2/C/S2, Analog)	Yes	Yes	Yes	Yes	Yes
Input & Output	My Channel	Yes	Yes	Yes	Yes	Yes
	Energy Saving Mode (BLU Control)	Yes	Yes	Yes	Yes	Yes
	RJ12/IR Pass Through	Yes	Yes	Yes	Yes	Yes
	TTX Clock Update (Analogue)	Yes	Yes	Yes	Yes	Yes
	USB Cloning	Yes	Yes	Yes	Yes	Yes
	Wake-up Timer (Alarm)	Yes	Yes	Yes	Yes	Yes
	Samsung LYNK™ DRM	Yes	Yes	Yes	Yes	Yes
	Security Mode	Yes	Yes	Yes	Yes	Yes
	USB	2	2	2	2	2
	Ethernet (LAN)	1	1	1	1	1
	Digital Audio Out (Optical)	1	1	1	1	1
Design	RF In (Terrestrial / Cable input / Satellite Input)	1/1(Common Use for Terrestrial)/1	1/1(Common Use for Terrestrial)/1	1/1(Common Use for Terrestrial)/1	1/1(Common Use for Terrestrial)/1	1/1(Common Use for Terrestrial)/1
	CI Slot	1	1	1	1	1
	HDMI A / Return Ch. Support	Yes	Yes	Yes	Yes	Yes
	WiFi	Yes (WiFi5)	Yes (WiFi5)	Yes (WiFi5)	Yes (WiFi5)	Yes (WiFi5)
	Anynet+ (HDMI-CEC)	Yes	Yes	Yes	Yes	Yes
	RJ12	Yes	Yes	Yes	Yes	Yes
Power	Front Color	BLACK	BLACK	BLACK	BLACK	BLACK
	Stand Type	NEW SIMPLE STAND	NEW SIMPLE STAND	NEW SIMPLE STAND	NEW SIMPLE STAND	NEW SIMPLE STAND
	Bezel Type	3 Bezel-less	3 Bezel-less	3 Bezel-less	3 Bezel-less	3 Bezel-less
	Eco Sensor	Yes	Yes	Yes	Yes	Yes
	Power Supply (V)	AC220-240V 50/60Hz	AC220-240V 50/60Hz	AC220-240V 50/60Hz	AC220-240V 50/60Hz	AC220-240V 50/60Hz
Dimension	Power Consumption (Max)	125 W	140 W	145 W	170 W	230 W
	Power Consumption (Energy Saving Mode)	N/A	N/A	N/A	N/A	N/A
	Power Consumption (Stand-by)	N/A	N/A	N/A	N/A	N/A
	Power Consumption (Typical)	N/A	N/A	N/A	N/A	N/A
Weight	Set Dimension without Stand (WxHxD)	965.5 x 559.4 x 25.7 mm	1118.3 x 644.1 x 25.7 mm	1232.1 x 708.3 x 25.7 mm	1450.9 x 831.4 x 25.7 mm	1676.7 x 959.8 x 26.6 mm
	Set Dimension with Stand (WxHxD)	965.5 x 598.1 x 181.0 mm	1118.3 x 681.7 x 224.0 mm	1232.1 x 745.9 x 224.0 mm	1450.9 x 872.2 x 274.0 mm	1676.7 x 997.3 x 320.0 mm
	Package Dimension (WxHxD)	1093 x 677 x 129 mm	1246 x 771 x 137 mm	1399 x 846 x 148 mm	1612 x 950 x 164 mm	1834 x 1110 x 190 mm
Accessory	Set Weight without Stand	8.4 kg	11.5 kg	15.5 kg	20.9 kg	31.4 kg
	Set Weight with Stand	8.6 kg	11.8 kg	15.8 kg	21.3 kg	32.0 kg
	Package Weight	11.8 kg	16.0 kg	22.0 kg	28.3 kg	42.3 kg
	Remote Controller Model	TM2280E	TM2280E	TM2280E	TM2280E	TM2280E
	Batteries (for Remote Control)	N/A (UK Yes)	N/A (UK Yes)	N/A (UK Yes)	N/A (UK Yes)	N/A (UK Yes)
	Samsung Smart Control (Included)	Yes	Yes	Yes	Yes	Yes
	Mini Wall Mount Supported	Yes	Yes	Yes	Yes	N/A
	VESA Wall Mount Supported	Yes	Yes	Yes	Yes	Yes
	Power Cable	Yes	Yes	Yes	Yes	Yes
	Quick Install Guide	Yes	Yes	Yes	Yes	Yes
	Data Cable	Yes	Yes	Yes	Yes	Yes
Optional Stand Support (Studio)	N/A	N/A	Yes	Yes	N/A	

Technical drawings

43"

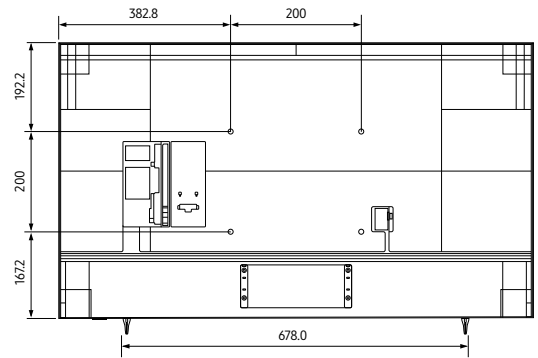
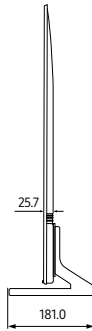
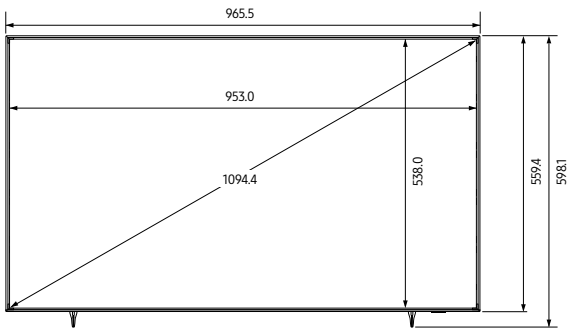

50"

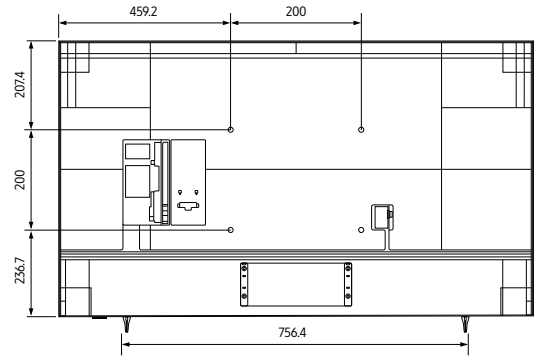
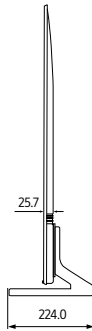
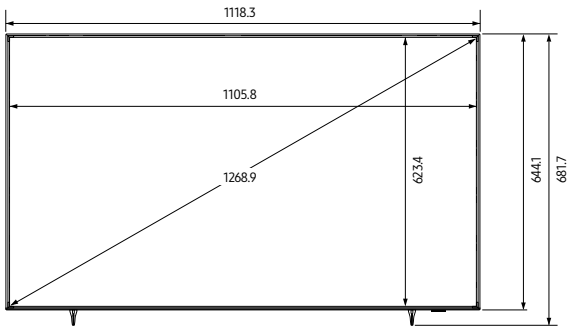

55"

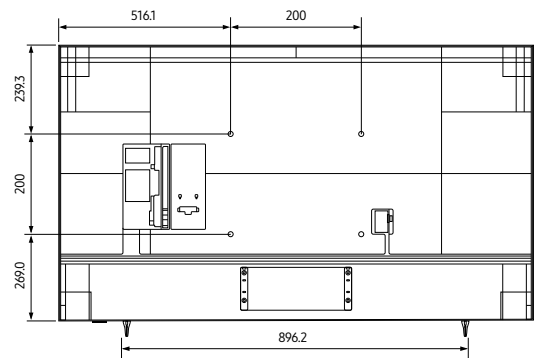
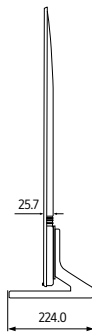
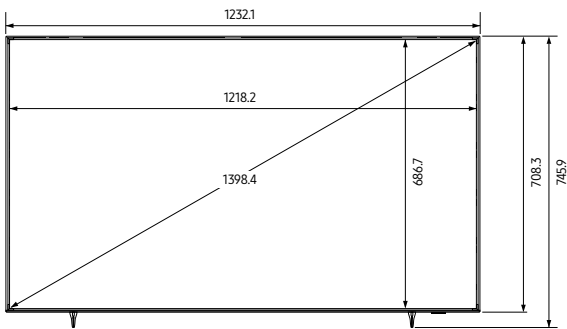

65"

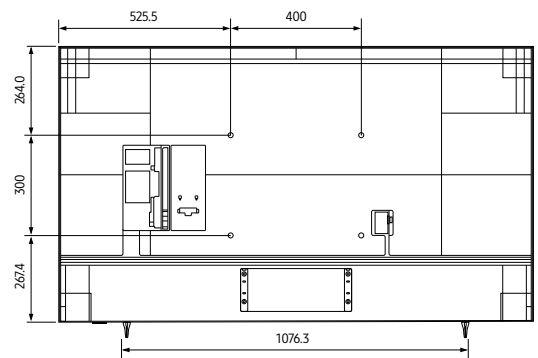
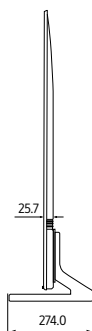
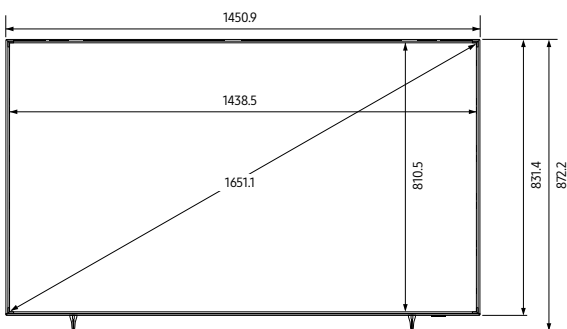

Technical drawings

75"

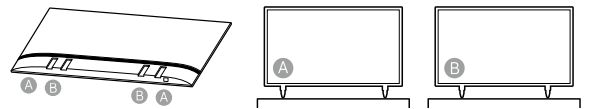
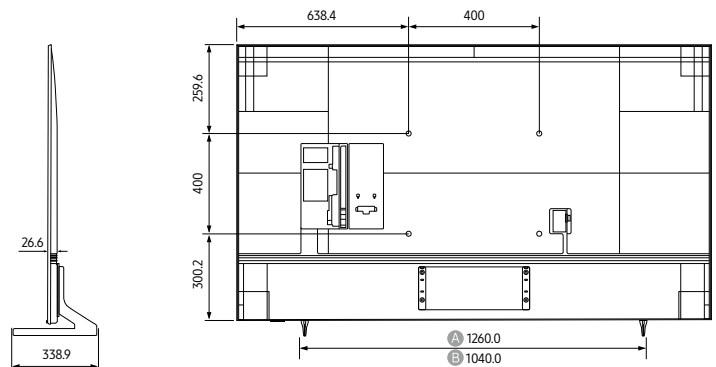
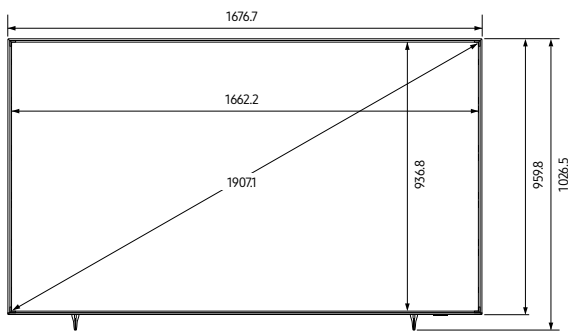

* There are two options for the 75" stand.
Customer can choose one of the two according to the situation.

Connectors

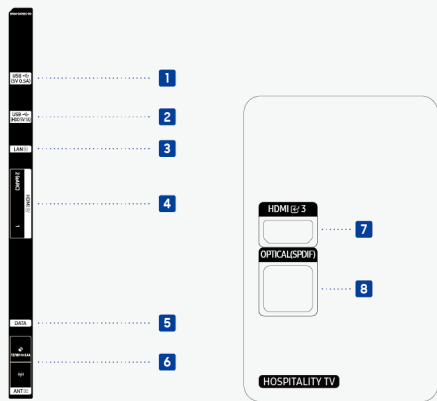

- 1 USB (5V 0.5A)
- 2 USB (HDD 5V 1A)
- 3 LAN IN
- 4 HDMI IN 2 (eARC)
HDMI IN 1
- 5 DATA
- 6 ANT IN
- 7 HDMI IN 3
- 8 OPTICAL (SPDIF)

About Samsung Electronics Co., Ltd.

Samsung Electronics Co., Ltd. inspires the world and shapes the future with transformative ideas and technologies. The company is redefining the worlds of TVs, smartphones, wearable devices, tablets, digital appliances, medical equipment, network systems, and semiconductor and LED solutions. For the latest news, please visit the Samsung Newsroom at news.samsung.com.

Hospitality Display

For more information about Samsung Hospitality Displays, visit www.samsung.com/business or www.samsung.com/displaysolutions

Copyright © 2022 Samsung Electronics Co. Ltd. All rights reserved. Samsung is a registered trademark of Samsung Electronics Co. Ltd. Specifications and designs are subject to change without notice. Non-metric weights and measurements are approximate. All data were deemed correct at time of creation. Samsung is not liable for errors or omissions. All brand, product, service names and logos are trademarks and/or registered trademarks of their respective owners and are hereby recognized and acknowledged.

Samsung Electronics Co., Ltd.
416, Maetan 3-dong, Yeongtong-gu, Suwon-si, Gyeonggi-do 443-772, Korea