



Simply Better Connections

ES0152 / ES0152P

52-Port GbE Managed Switch

User Manual

Compliance Statements

FEDERAL COMMUNICATIONS COMMISSION INTERFERENCE STATEMENT

This equipment has been tested and found to comply with the limits for a Class A digital device, pursuant to Part 15 of the FCC Rules. These limits are designed to provide reasonable protection against harmful interference when the equipment is operated in a commercial environment. This equipment generates, uses, and can radiate radio frequency energy and, if not installed and used in accordance with the instruction manual, may cause harmful interference to radio communications. Operation of this equipment in a residential area is likely to cause harmful interference in which case the user will be required to correct the interference at his own expense.

The device complies with Part 15 of the FCC Rules. Operation is subject to the following two conditions: (1) this device may not cause harmful interference, and (2) this device must accept any interference received, including interference that may cause undesired operation.

FCC Caution

Any changes or modifications not expressly approved by the party responsible for compliance could void the user's authority to operate this equipment.

Warning

Operation of this equipment in a residential environment could cause radio interference.

Achtung

Der Gebrauch dieses Geräts in Wohnumgebung kann Funkstörungen verursachen.



KCC Statement

유선 제품용 / A 급 기기 (업무용 방송 통신 기기)
이 기기는 업무용 (A 급) 전자파적합기기로서 판매자 또는 사용자는 이
점을 주의하시기 바라며, 가정 외의 지역에서 사용하는 것을 목적으로
합니다.

RoHS

This product is RoHS compliant.

User Information

Online Registration

Be sure to register your product at our online support center:

International	http://eservice.aten.com
---------------	---

Telephone Support

For telephone support, call this number:

International	886-2-8692-6959
China	86-400-810-0-810
Japan	81-3-5615-5811
Korea	82-2-467-6789
North America	1-888-999-ATEN ext 4988 1-949-428-1111

User Notice

All information, documentation, and specifications contained in this manual are subject to change without prior notification by the manufacturer. The manufacturer makes no representations or warranties, either expressed or implied, with respect to the contents hereof and specifically disclaims any warranties as to merchantability or fitness for any particular purpose. Any of the manufacturer's software described in this manual is sold or licensed *as is*. Should the programs prove defective following their purchase, the buyer (and not the manufacturer, its distributor, or its dealer), assumes the entire cost of all necessary servicing, repair and any incidental or consequential damages resulting from any defect in the software.

The manufacturer of this system is not responsible for any radio and/or TV interference caused by unauthorized modifications to this device. It is the responsibility of the user to correct such interference.

The manufacturer is not responsible for any damage incurred in the operation of this system if the correct operational voltage setting was not selected prior to operation. PLEASE VERIFY THAT THE VOLTAGE SETTING IS CORRECT BEFORE USE.

Product Information

For information about all ATEN products and how they can help you connect without limits, visit ATEN on the Web or contact an ATEN Authorized Reseller. Visit ATEN on the Web for a list of locations and telephone numbers:

International	http://www.aten.com
---------------	---

Package Contents

Check to make sure that all the components are in working order. If you encounter any problem, please contact your dealer.

ES0152 / ES0152P

- 1 GbE Managed Switch / GbE PoE Managed Switch
- 1 AC power cord
- 1 RJ-45 to DB-9 serial console cable
- 1 mounting kit
- 1 foot pad set (4 pcs)
- 1 user instructions

Content

Compliance Statements	ii
User Information	iii
Online Registration	iii
Telephone Support	iii
User Notice	iii
Product Information	iv
Package Contents	v
ES0152 / ES0152P	v
Content	vi
About This Manual	xiii
Overview	xiii
Conventions	xiv
Chapter 1.Introduction	
Overview	1
Features	2
Components	3
ES0152 Front View	3
ES0152P Front View	3
System LED	4
Port Status LED	5
ES0152 / ES0152P Rear View	7
Web Interface	8
Initial Configuration and Logging In	8
Chapter 2.Installation	
Mounting	11
Rack Mount	11
Desk Mount	12
Installing SFP+ Modules	13
Hardware Installation	14
Chapter 3.System	
Overview	15
System Information	16
IP Address	19
Settings	19
Advanced Settings	21
Status	26
IP Status	26
Routing Info Base	27
System Time	31
LLDP	35
LLDP Configuration	35
LLDP-MED Configuration	38

LLDP Neighbor	49
LLDP-MED Neighbor	52
LLDP Neighbor PoE	57
LLDP Neighbor EEE	58
LLDP Statistics	61

Chapter 4.Port Management

Overview	65
Port Management	66
Port Configuration	66
Port Statistics	68
SFP Port Info	72
Energy Efficient Ethernet	74
Link Aggregation	76
Static Configuration	76
LACP Configuration	78
System Status	79
Internal Status	81
Neighbor Status	83
Port Status	85
Loop Protection	88
Configuration	88
Status	90
UDLD	92
UDLD Configuration	92
UDLD Status	93

Chapter 5.PoE Management (ES0152P Only)

Overview	97
PoE Configuration	98
PoE Status	101
PoE Power Delay	104
PoE Auto Checking	106
PoE Scheduling Profile	108

Chapter 6.VLAN Management

Overview	111
VLAN Configuration	112
VLAN Membership	117
VLAN Port Status	120
MAC-based VLAN	123
Configuration	123
Status	125
Protocol-based VLAN	127
Protocol to Group	127
Group to VLAN	130
IP Subnet-based VLAN	132

GVRP	134
Private VLAN	136
Port Isolation	138
Voice VLAN	140
Configuration	140
OUI	142

Chapter 7. Quality of Server (QoS)

Overview	145
Port Classification	146
Port PCP Classification	148
Port Policers	150
Port Shapers	152
Storm Control	155
Port Scheduler	158
Port PCP Remarking	161
DSCP	164
Port DSCP	164
DSCP Translation	165
DSCP Classification	167
DSCP-Based QoS	168
QoS Control List	171
Configuration	171
Status	177
QoS Statistics	180
WRED	182

Chapter 8. Spanning Tree

Overview	185
STP Configuration	187
MSTI Configuration	190
STP Status	194
Port Statistics	199

Chapter 9. MAC Address Tables

Overview	201
Configuration	202
Information	205

Chapter 10. Multicast

Overview	207
IGMP Snooping	208
Basic Configuration	209
VLAN Configuration	211
Status	213
Group Information	215
IGMP SFM Information	217

MLD Snooping	221
Basic Configuration	222
VLAN Configuration	224
Status	226
Groups Information	228
MLD SFM Information	230
MVR	233
Basic Configuration	233
Statistics	236
MVR Groups Information	237
MVR SFM Information	239
Multicast Filtering Profile	243
Filtering Profile Table	243
Filtering Address Entry	246
Chapter 11.DHCP	
Overview	249
Snooping	250
Configuration	250
Snooping Table	251
Detailed Statistics	253
Relay	256
Configuration	256
Statistics	258
Server	261
Configuration	261
Status	262
Chapter 12.Security	
Overview	265
Management	266
Account	266
Privilege Levels	268
Auth Method	271
Access Method	274
HTTPS	275
802.1X	278
Configuration	278
Status	289
IP Source Guard	292
Configuration	292
Static Table	293
Dynamic Table	295
ARP Inspection	298
Configuration	298
VLAN Configuration	300
Static Table	302

Dynamic Table	304
Port Security	307
Configuration.....	307
Status	310
RADIUS	314
Configuration.....	314
Status	317
TACACS+	325

Chapter 13.Access Control

Overview	329
Port Configuration	330
Rate Limiters	333
Access Control List	335
ACL Status	352

Chapter 14.SNMP

Overview	355
Configuration	357
SNMPv3	359
Communities	359
Users	360
Groups	363
Views	365
Access	367
Statics	371
Configuration.....	371
Statistics	372
History	376
Configuration.....	376
Status	377
Alarm	381
Configuration.....	381
Status	384
Event	387
Configuration.....	387
Status	388

Chapter 15.Event Notification

Overview	391
SNMP Trap	392
eMail	396
Log	398
Syslog	398
View Log	399
Event Configuration	402

Chapter 16. Diagnostics

Overview	405
Ping	406
Traceroute	408
Cable Diagnostics	410
Mirroring	412
sFlow	414
Configuration	414
Statistics	417

Chapter 17. Maintenance

Overview	421
Configuration	422
Save Startup-Config	422
Backup	423
Restore	424
Activate	425
Delete	426
Restart Device	428
Factory Defaults	429
Firmware	430
Firmware Upgrade	430
Firmware Selection	430

Chapter 18. Device Management System (DMS)

Overview	433
Management	435
DMS Mode	435
Map API Key	436
Device List	437
Graphical Monitoring	439
Topology View	439
Floor View	446
Map View	447
Maintenance	448
Floor Image	448
Diagnostics	449
IP Routes Configuration	450

Appendix

Safety Instructions	453
General	453
Rack Mounting	455
Consignes de sécurité	457
Général	457
Montage sur bâti	460
Technical Support	461

International	461
North America	461
Troubleshoot	462
Specifications	463
Limited Warranty.....	464

About This Manual

This User Manual provides specific information about using the web interface to operate this switch.

Overview

Chapter 1, *Introduction*, introduces you to the 52-Port GbE (PoE) Managed Switch. Its purpose, features and benefits are presented, its front and rear panel components are described.

Chapter 2, *Installation*, provides hardware instructions for setting up the switch.

Chapters 3-17, describes the configurations available via the side menu of the web interface.

Chapter 18, *Device Management System (DMS)*, explains the DMS intelligent management tool and provides information to help you manage the switch.

Appendix, at the end of the manual provides technical and troubleshooting information.

Note:

- ◆ Read this manual thoroughly and follow the installation and operation procedures carefully to prevent any damage to the unit or any connected devices.
 - ◆ The product may be updated, with features and functions added, improved or removed since the release of this manual. For an up-to-date user manual, visit <http://www.aten.com/global/en>
-

Conventions

This manual uses the following conventions:

- | | |
|---|--|
| Monospaced | Indicates text that you should key in. |
| [] | Indicates keys you should press. For example, [Enter] means to press the Enter key. If keys need to be chorded, they appear together in the same bracket with a plus sign between them: [Ctrl+Alt]. |
| 1. | Numbered lists represent procedures with sequential steps. |
| ◆ | Bullet lists provide information, but do not involve sequential steps. |
| > | Indicates selecting the option (on a menu or dialog box, for example), that comes next. For example, Start > Run means to open the <i>Start</i> menu, and then select <i>Run</i> . |
|  | Indicates critical information. |

Chapter 1

Introduction

Overview

The ES0152 / ES0152P is a feature-rich GbE managed switch for ATEN KE series KVM over IP extenders and VE89 series Video over IP extenders*. Ideal for installation in combination with the KE / VE89 series products, the ES0152 / ES0152P helps users build their OT infrastructure with the KE series by eliminating the hassles of complicated setup.

Deploying the ES0152 / ES0152P is fast and easy. With everything plug and play, there is no need to install software or configure devices. Simply connect the KE / VE89 transmitters and receivers to the ES0152 / ES0152P using Cat 5e/6 cables and all KE / VE89 series devices on the same LAN will automatically be detected.

The ES0152 / ES0152P network switch provides a 52-port, high-performance configuration, a complete array of L2 features and advanced functionalities including Layer 3 static route, DHCP server, IPv6 support and LLDP, delivering a versatile solution for improving network performance.

Both the ES0152 and the ES0152P offer a combination of SFP+ (fiber) and RJ45 (copper) ports for servicing a range of network needs. The ES0152 delivers 4 (1G/10G) SFP+ and 48 (10M/100M/1G) RJ45 ports while the ES0152P supports 4 (1G/10G) SFP+ and 48 (10M/100M/1G) RJ45 with PoE+ (Support 802.3at/af) ports. Featuring Power over Ethernet (PoE) function, the ES0152P can provide up to 740 Watts power budget across 48 RJ45 ports thus eliminating the need for a power adapter and effectively reducing the power configuration cost.

The ES0152 / ES0152P comes with embedded DMS functions to facilitate device management anytime and anywhere. Its intuitive, user-friendly interface enables IT administrators to set up and manage their networks and all the connected KE / VE89 devices effortlessly. It also has comprehensive security features such as IP source guard and ACL to guard your network from unauthorized access.

With a full range of functions to help with optimizing network efficiency, manageability and reliability for their network environment, the ES0152 / ES0152P is an ideal network switch solution for SMBs and enterprises, and even more so for those that have chosen to adopt ATEN KE series KVM over

IP extenders or VE89 series Video over IP extenders into their OT infrastructure.

Note: Please visit www.aten.com for compatible products.

Features

- ◆ Auto detects KE/VE89 series devices
- ◆ Plug-and-play without additional settings
- ◆ Supports IGMP Snooping Fast Leave
- ◆ Supports Flow Control
- ◆ Supports IGMP v1/v2/v3 Snooping and IGMP v1/v2 Querier
- ◆ Supports 48 Gigabit Ethernet ports and 4 SFP+ uplink ports (10Gbps)
- ◆ High-performance Gigabit Ethernet L2 access switch with 176 Gbps switching capacity - significantly improve the responsiveness of applications and file transfer times
- ◆ Built in Device Management System (DMS) to provide an overview of all connected KE/VE89 devices for management
- ◆ Supports IEEE 802.1w Rapid Spanning Tree Protocol – ensuring a faster recovery from failed links and enhancing overall network stability and reliability
- ◆ Comprehensive QoS – allowing the marking, classification, and scheduling of up to four traffic types across the network
- ◆ Enhanced Security - Port Security limits the total number of devices using a switch port and protects against MAC flooding attacks
- ◆ IPv4/IPv6 Management
- ◆ 802.3af PoE/ 802.3at PoE+ Port configuration and scheduling (ES0152P only)

Components

ES0152 Front View

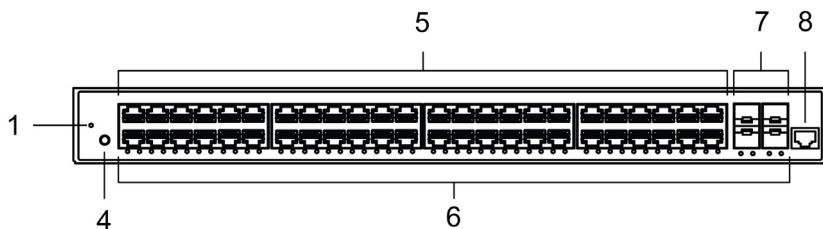

ES0152P Front View

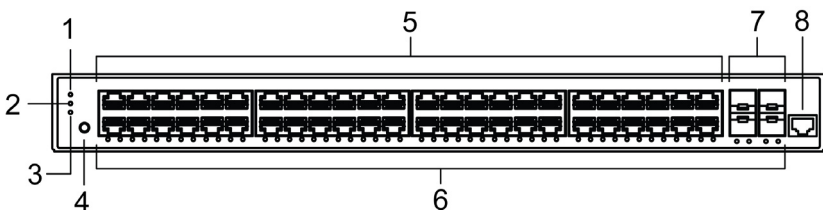

No.	Component	ES0152P
1	system LED	indicates if the switch is powered up correctly or not, or, indicates if there is a system alarm triggered for troubleshooting. Refer to <i>System LED</i> on page 4 for the behavior of the LED.
2	link/act/spd LED (ES0152P only)	When this LED is lit, the port status LEDs are displaying the link status, network activity and speed of each port. Refer to <i>Port Status LED</i> on page 5 for the behavior of the LED. Users can press the Mode button to toggle between Link/Activity/Speed mode and PoE mode.
3	PoE LED (ES0152P only)	When this LED is lit, the port status LEDs are displaying PoE powering status of each port. Refer to <i>Port Status LED</i> on page 5 for the behavior of the LED. Users can press the Mode button to toggle between Link/Activity/Speed mode and PoE mode.

No.	Component	ES0152P
4	mode / reset button	<p>By pressing the Mode/Reset Button for a different period of time, users can reset the switch, restore the switch to factory defaults, or change the display definition of port status LEDs (ES0152P only):</p> <ul style="list-style-type: none"> ◆ Restore to default: Press and hold the button for 7-12 seconds. The system LED will start blinking while all port status LEDs will stay on. ◆ Reset the switch: Press and hold the button for 2-7 seconds. The system LED will start blinking while all port status LEDs will turn off. ◆ (ES0152P only) Change port status LEDs definition: Press and hold the button for 0-2 seconds. The system LED will turn on while the port status LEDs will behave according to <i>Port Status LED</i> on page 5.
5	10/100/1000 RJ-45 ports	
6	port status LEDs	Indicates the status of the connected port. Refer to <i>Port Status LED</i> on page 5 for more details.
7	10G SFP+ ports	
8	console port	Connect RJ-45 to DB-9 Serial Console Cable for CLI operation. Refer to the <i>CLI User Manual</i> for the CLI commands.

System LED

Color	State	Description
green	on	The switch is powered ON correctly.
	off	The switch is not receiving power.
red	on	An abnormal state, such as exceeding operating temperature range, has been detected in the switch.

Port Status LED

The port status LED behavior is shown in the following table:

Port	Color	State	Description
RJ45 ports	green	on	The port is enabled and established a link to connected device, and the connection speed is 1000Mbps.
	green	blinking	The port is transmitting/receiving packets, and the connection speed is 1000Mbps.
	amber	on	The port is enabled and established a link to connected device, and the connection speed is 10/100Mbps.
	amber	blinking	The port is transmitting/receiving packets, and the connection speed is 10/100Mbps.
	--	off	The port has no active network cable connected, or it has not established a link to the connected device. Otherwise, the port may have been disabled through the switch user interface.
SFP+ ports	blue	on	The port is enabled and established a link to connected device, and the connection speed is 10Gbps.
	blue	blinking	The port is transmitting/receiving packets, and the connection speed is 10Gbps.
	green	on	The port is enabled and established a link to connected device, and the connection speed is 1Gbps.
	green	blinking	The port is transmitting/receiving packets, and the connection speed is 1Gbps.
	--	off	The port has no active network cable connected, or it has not established a link to the connected device. Otherwise, the port may have been disabled through the switch user interface.

■ When Link/Act/Speed LED is Lit (ES0152P only)

The behavior of the port status LED is the same as the table above.

■ When PoE LED is Lit (ES0152P only)

Port	Color	State	Description
RJ45 ports	green	on	The port is enabled and supplying power to the connected device.
	amber	on	An abnormal state, such as overload status, that has been detected in the switch.
	--	off	The port has no active network cable connected, or it is not connected a PoE PD device. Otherwise, the port may have been disabled through the switch user interface.

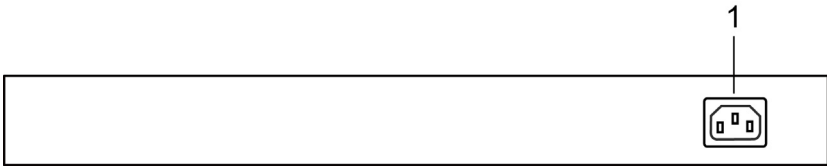
ES0152 / ES0152P Rear View

No.	Component	Description
1	Power Connector	Connect the provided power cord to this socket and an AC wall power socket to power the device.

Web Interface

The features and functions of the switch can be configured and managed via the web interface, which are laid out in the chapters starting from Chapter 3 *System*.

Initial Configuration and Logging In

When powering up the switch for the first time, you can perform the initial switch configuration using the web interface.

To begin with the initial configuration stage, you need to reconfigure your PC's IP address and subnet mask to allow communication between your PC and the switch.

Factory default IP Address of the switch: 192.168.0.1

Factory default Subnet Mask of the switch: 255.255.255.0

Factory default Gateway of the switch: 192.168.0.254

After changing your PC's IP address (for example, 192.168.0.250), you can access the Web interface of the switch using the switch's default IP address (192.168.0.1).

The initial switch configuration procedure example, for a PC running Windows® 7/8.x/10, is as follows:

1. Type "*network and sharing*" into the **Search box** in the **Start Menu**.
2. Select **Network and Sharing Center**.
3. Click on **Change adapter settings** on the left of PC screen.

Note: Users can also skip step 1 to 3, by pressing **WinKey+R** and type "*ncpa.cpl*" command to get to step 4 directly.

4. Right-click on your local adapter and select **Properties**.
5. In the **Local Area Connection Properties** window highlight **Internet Protocol Version 4 (TCP/IPv4)** then click the **Properties** button.

Note: Record all your PC's current IP settings to be able to restore them later.

6. Select the radio button **Use the following IP address** and enter the IP for the PC (e.g. any IP address not in use, and in between *192.168.0.2* and *192.168.0.254*), Subnet mask (e.g. *255.255.255.0*), and Default gateway

that corresponds to your network setup. Then enter your Preferred and Alternate DNS server addresses.

7. Click **OK** to change the PC's IP address.
8. Open a web browser on the PC and enter the factory default IP address to access the switch's web interface. A login page appears:

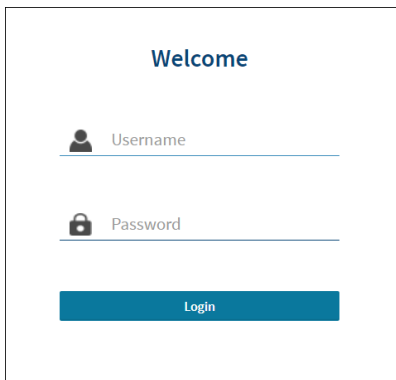

Note: If you do not see the above login page, please try the following:

1. Refresh the web page.
 2. Check to see if there is an IP conflict issue.
 3. Clean browser cookies and temporary internet files.
 4. Check your PC settings again and repeat step 2.
9. Enter the username and password. The default username is admin. A preprogrammed password (inside the red square box below) unique to each switch is provided on the sticker of the bottom side of the switch. An example is shown:

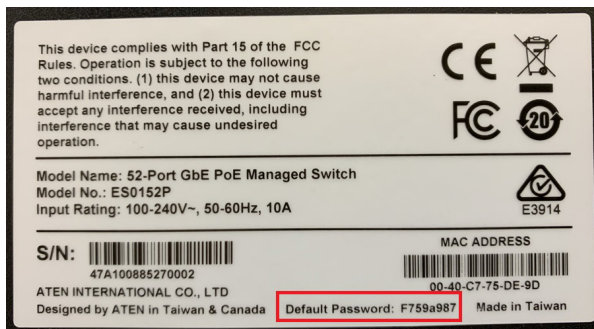

10. Click “Login” to log into the switch.

Note: If you wish to change the password, go to **Security > Management > Account** and click **admin** (name of user). Enter the new password, repeat it and click **Apply**.

Chapter 2

Installation

Mounting

Rack Mount

Follow the steps below to rack mount the device.

1. Attach the mounting brackets to both sides of the chassis. Insert screws and tighten them with a screwdriver to secure the brackets.

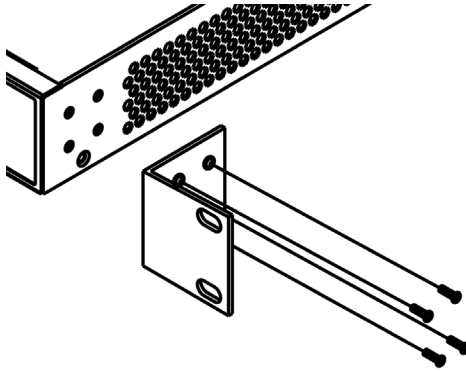

2. Place the switch on a rack shelf in the rack. Push it in until the oval holes in the brackets align with the mounting holes in the rack posts.

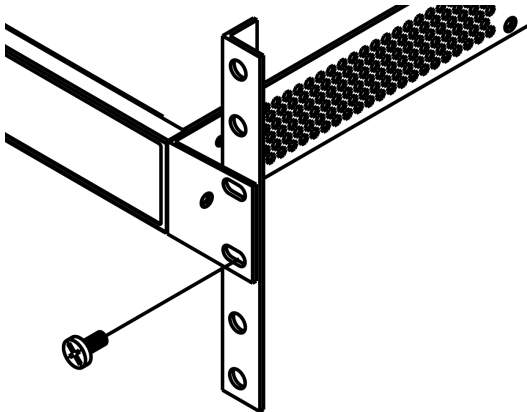

3. Attach the brackets to the posts. Insert screws and tighten them.

Desk Mount

1. It is recommended to verify that the desk/bench is sturdy for the device to be mounted on and that it is reliably grounded.
2. Attach the four adhesive rubber feet to the bottom of the switch.

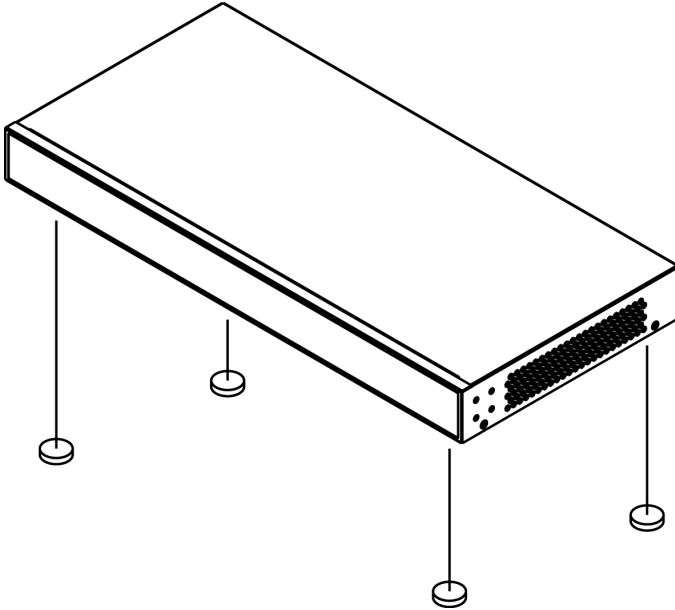

Installing SFP+ Modules

As an option accessory for the SFP+ ports, you can install a mini-GBIC SFP+ module. Since the connection capability of the SFP+ ports is up to 10Gbps, you can choose mini-GBIC SFP+ modules able to support data rates of up to 10Gbps. You can install the module even while the switch is powered.

1. Insert the module into the SFP+ port.
2. Press firmly to ensure that the module seats into the connector.

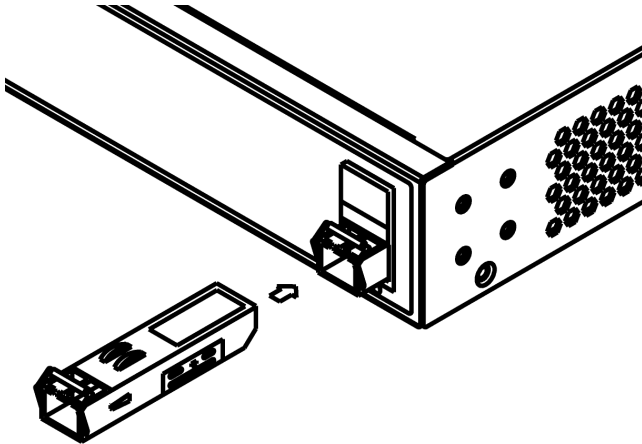

Hardware Installation

Connect the power cord between the ES0152 / ES0152P's power socket and an AC source, check the system LED if the switch is powered on. Connect an Ethernet LAN cable between the switch's RJ-45 port and the Ethernet RJ-45 port on the KE / VE89 Series extenders. If the port status LED is blinking, the switch is ready.

An example is shown:

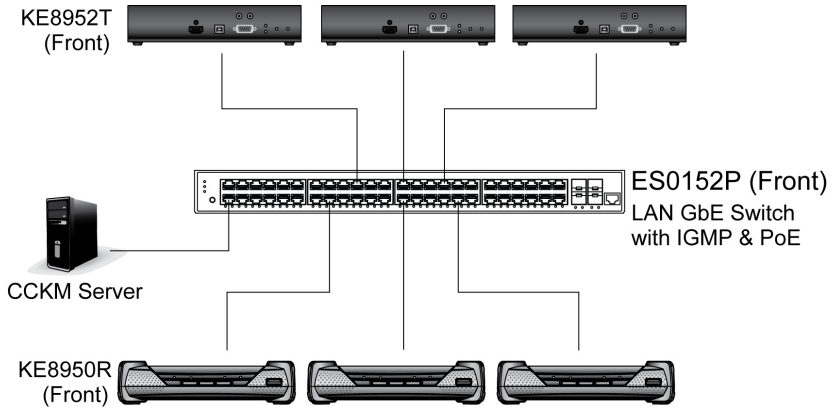

Overview

This chapter describes the entire basic configuration tasks.

The menu and the submenu are shown below:

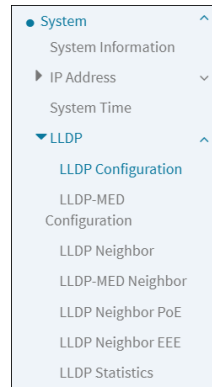
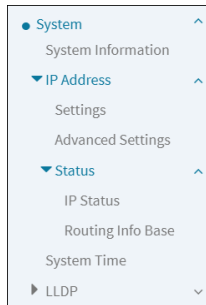
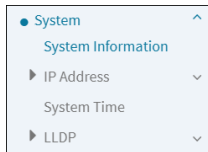

System Information

On this page, you can configure the Location, Contact and System name of the device as well as look through the system's information. The switch system's contact information is also provided here.

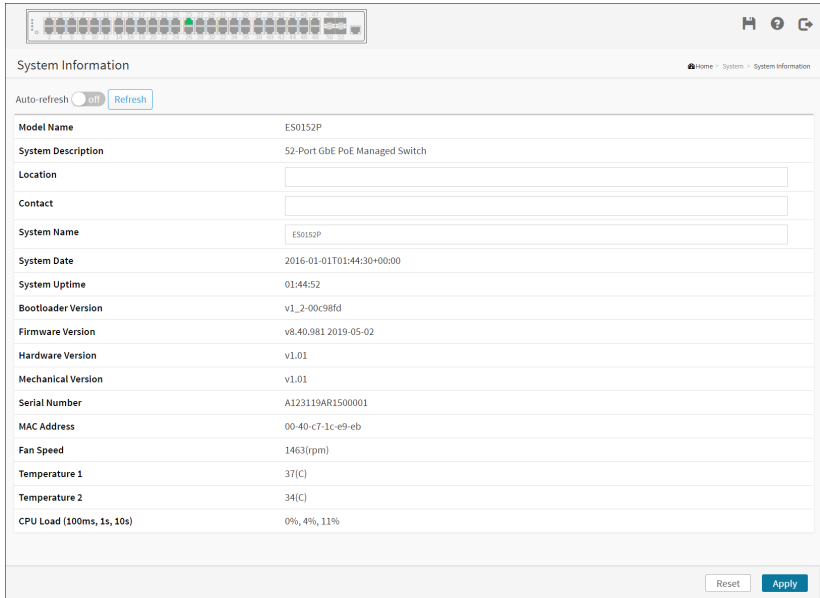

Model Name	ES0152P
System Description	52-Port GbE PoE Managed Switch
Location	<input type="text"/>
Contact	<input type="text"/>
System Name	ES0152P
System Date	2016-01-01T01:44:30+00:00
System Uptime	01:44:52
Bootloader Version	v1_2-00c98fd
Firmware Version	v8.40.981 2019-05-02
Hardware Version	v1.01
Mechanical Version	v1.01
Serial Number	A123119AR1500001
MAC Address	00-40-c7-1c-e9-eb
Fan Speed	1463(rpm)
Temperature 1	37(C)
Temperature 2	34(C)
CPU Load (100ms, 1s, 10s)	0%, 4%, 11%

■ Parameter description

Model Name:

Displays the factory defined model name for identification purpose.

System Description:

Displays the system description.

Location:

The system location configured in Configuration > System > Information > System Location.

Contact:

The system contact configured in Configuration > System > Information > System Contact.

System name:

Displays the user-defined system name that configured in System > System Information > Configuration > System Name.

System Date:

The current (GMT) system time and date. The system time is obtained through the Timing server running on the switch, if any.

System Uptime:

The period of time the device has been operational.

Bootloader Version:

Displays the current boot loader version number.

Firmware Version:

The software version of this switch.

Hardware Version:

Displays the hardware version of the device.

Mechanical Version:

Displays the mechanical version of the device.

Series Number:

The serial number of this switch.

MAC Address:

The MAC Address of this switch.

Fan Speed:

Displays the information about fan speed [rpm].

Temperature 1:

Displays the temperature 1 of the system.

Temperature 2:

Displays the temperature 2 of the system.

CPU Load (100ms, 1s, 10s):

Displays the CPU loading (100ms, 1s, 10s) of the system.

■ Buttons

Apply:

Click to save changes.

Reset:

Click to undo any changes made locally and revert to previously saved values.

IP Address

Settings

The IPv4 address for the switch could be obtained via DHCP Server for VLAN 1. To manually configure an address, you need to change the switch's default settings to values that are compatible with your network. You may also need to establish a default gateway between the switch and management stations that exist on another network segment.

Settings	
IPv4 DHCP Client Enable	<input type="checkbox"/> off
IPv4 Address	192.168.0.1
Subnet Mask	255.255.255.0
Gateway	192.168.0.254
DNS Server	No DNS server

[Apply](#)

To configure the IP Settings:

1. Click System, IP Address and Settings.
2. Enable or Disable the IPv4 DHCP Client.
3. Specify the IPv4 Address, Subnet Mask, Gateway.
4. Select DNS Server.
5. Click Apply

■ Parameter description:

IPv4 DHCP Client Enable:

Enable the DHCP client by checking this box. If this option is enabled, the system will configure the IPv4 address and mask of the interface using the DHCP protocol. The DHCP client will announce the configured System Name as hostname to provide DNS lookup.

IPv4 Address:

The IPv4 address of the interface in dotted decimal notation.

If DHCP is enabled, this field is not used. The field may also be left blank if IPv4 operation on the interface is not desired.

Subnet Mask:

User IP subnet mask of the entry.

Gateway:

The IP address of the IP gateway. Valid format is dotted decimal notation or a valid IPv6 notation. Gateway and Network must be of the same type.

DNS Server:

This setting controls the DNS name resolution done by the switch.

There are four servers available for configuration, and the index of the server presents the preference (less index has higher priority) in doing DNS name resolution.

The following modes are supported:

- ◆ No DNS server
No DNS server will be used.
- ◆ Configured IPv4
Explicitly provide the valid IPv4 unicast address of the DNS Server in dotted decimal notation.
Make sure the configured DNS server could be reachable (e.g. via PING) for activating DNS service.
- ◆ Configured IPv6
Explicitly provide the valid IPv6 unicast (except linklocal) address of the DNS Server.
Make sure the configured DNS server could be reachable (e.g. via PING6) for activating DNS service.
- ◆ From any DHCPv4 interfaces
The first DNS server offered from a DHCPv4 lease to a DHCPv4-enabled interface will be used.
- ◆ From this DHCPv4 interface
Specify from which DHCPv4-enabled interface a provided DNS server should be preferred.
- ◆ From any DHCPv6 interfaces

The first DNS server offered from a DHCPv6 lease to a DHCPv6-enabled interface will be used.

- ◆ From this DHCPv6 interface
Specify from which DHCPv6-enabled interface a provided DNS server should be preferred.

■ Buttons

Apply:

Click to save changes.

Advanced Settings

Configure the switch-managed IP information on this page

Configure IP basic settings, control IP interfaces and IP routes.

The maximum number of interfaces supported is 8 and the maximum number of routes is 8.

The screenshot shows the 'Advanced Settings' page in a web interface. At the top, there is a breadcrumb trail: Home > System > IP Address > Advanced Settings. The page is divided into several sections:

- Mode:** A dropdown menu set to 'Host'.
- DNS Server 1, 2, 3, 4:** Each has a dropdown menu set to 'No DNS server' and an adjacent text input field.
- DNS Proxy:** A checkbox that is currently unchecked.
- IP Interfaces:** A table with columns for 'Delete', 'VLAN', 'IPv4 DHCP' (Enable, Fallback), 'IPv4' (Current Lease, Address, Mask Length), 'IPv6 DHCP' (Enable, Rapid Commit), 'IPv6' (Current Lease, Address, Mask Length). One interface is listed with VLAN 1, IPv4 address 192.168.0.1, and mask length 24.
- Link-Local Address binding interface:** A dropdown menu set to 'VLAN 1'.
- IP Routes:** A table with columns for 'Delete', 'Network', 'Mask Length', 'Gateway', and 'Distance/Next Hop VLAN'. Three routes are listed: 0.0.0.0/0 with gateway 192.168.0.254, 169.254.0.0/16 with gateway 192.168.0.1, and 192.168.0.0/24 with gateway 192.168.0.1.

At the bottom right, there are 'Reset' and 'Apply' buttons.

To configure an Advanced Settings in the web interface:

1. Click System, IP Address and Advanced Settings.

2. Click Add Interface then you can create new Interface on the switch.
3. Click Add Route then you can create new Route on the switch.
4. Click Apply.

■ Parameter description:

Basic Setting

Mode:

Configure whether the IP stack should act as a Host or a Router. In Host mode, IP traffic between interfaces will not be routed. In Router mode traffic is routed between all interfaces.

DNS Server:

This setting controls the DNS name resolution done by the switch. There are four servers available for configuration, and the index of the server presents the preference (less index has higher priority) in doing DNS name resolution.

The following modes are supported:

- ◆ No DNS server
No DNS server will be used.
- ◆ Configured IPv4
Explicitly provide the valid IPv4 unicast address of the DNS Server in dotted decimal notation.
Make sure the configured DNS server could be reachable (e.g. via PING) for activating DNS service.
- ◆ Configured IPv6
Explicitly provide the valid IPv6 unicast (except linklocal) address of the DNS Server.
Make sure the configured DNS server could be reachable (e.g. via PING6) for activating DNS service.
- ◆ From any DHCPv4 interfaces
The first DNS server offered from a DHCPv4 lease to a DHCPv4-enabled interface will be used.
- ◆ From this DHCPv4 interface
Specify from which DHCPv4-enabled interface a provided DNS server should be preferred.
- ◆ From any DHCPv6 interfaces

The first DNS server offered from a DHCPv6 lease to a DHCPv6-enabled interface will be used.

- ◆ From this DHCPv6 interface
Specify from which DHCPv6-enabled interface a provided DNS server should be preferred.

DNS Proxy:

When DNS proxy is enabled, system will relay DNS requests to the currently configured DNS server, and reply as a DNS resolver to the client devices on the network.

Only IPv4 DNS proxy is now supported.

IP Interfaces

Delete:

Select this option to delete an existing IP interface.

VLAN:

The VLAN associated with the IP interface. Only ports in this VLAN will be able to access the IP interface. This field is only available for input when creating a new interface.

IPv4 DHCP Enabled:

Enable the DHCP client by checking this box. If this option is enabled, the system will configure the IPv4 address and mask of the interface using the DHCP protocol. The DHCP client will announce the configured System Name as hostname to provide DNS lookup.

IPv4 DHCP Fallback Timeout:

The number of seconds for trying to obtain a DHCP lease. After this period expires, a configured IPv4 address will be used as IPv4 interface address. A value of zero disables the fallback mechanism, such that DHCP will keep retrying until a valid lease is obtained. Legal values are 0 to 4294967295 seconds.

IPv4 DHCP Current Lease:

For DHCP interfaces with an active lease, this column show the current interface address, as provided by the DHCP server.

IPv4 Address:

The IPv4 address of the interface in dotted decimal notation.

If DHCP is enabled, this field is not used. The field may also be left blank if IPv4 operation on the interface is not desired.

IPv4 Mask Length:

The IPv4 network mask, in number of bits (prefix length). Valid values are between 0 and 30 bits for a IPv4 address.

If DHCP is enabled, this field is not used. The field may also be left blank if IPv4 operation on the interface is not desired.

DHCPv6 Enable

Enable the DHCPv6 client by checking this box. If this option is enabled, the system will configure the IPv6 address of the interface using the DHCPv6 protocol.

DHCPv6 Rapid Commit

Enable the DHCPv6 Rapid-Commit option by checking this box. If this option is enabled, the DHCPv6 client terminates the waiting process as soon as a Reply message with a Rapid Commit option is received.

This option is only manageable when DHCPv6 client is enabled.

DHCPv6 Current Lease

For DHCPv6 interface with an active lease, this column shows the interface address provided by the DHCPv6 server.

IPv6 Address:

The IPv6 address of the interface. A IPv6 address is in 128-bit records represented as eight fields of up to four hexadecimal digits with a colon separating each field (:). For example, fe80::215:c5ff:fe03:4dc7. The symbol :: is a special syntax that can be used as a shorthand way of representing multiple 16-bit groups of contiguous zeros; but it can appear only once. It can also represent a legally valid IPv4 address. For example, ::192.1.2.34.

The field may be left blank if IPv6 operation on the interface is not desired.

IPv6 Mask Length:

The IPv6 network mask, in number of bits (prefix length). Valid values are between 1 and 128 bits for a IPv6 address.

The field may be left blank if IPv6 operation on the interface is not desired.

IP Routes

Delete:

Select this option to delete an existing IP route.

Network:

The destination IP network or host address of this route. Valid format is dotted decimal notation or a valid IPv6 notation. A default route can use the value 0.0.0.0 or IPv6 :: notation.

Mask Length:

The destination IP network or host mask, in number of bits (prefix length). It defines how much of a network address that must match, in order to qualify for this route. Valid values are between 0 and 32 bits respectively 128 for IPv6 routes. Only a default route will have a mask length of 0 (as it will match anything).

Gateway:

The IP address of the IP gateway. Valid format is dotted decimal notation or a valid IPv6 notation. Gateway and Network must be of the same type.

Next Hop VLAN (Only for IPv6):

The VLAN ID (VID) of the specific IPv6 interface associated with the gateway.

The given VID ranges from 1 to 4094 and will be effective only when the corresponding IPv6 interface is valid.

If the IPv6 gateway address is link-local, it must specify the next hop VLAN for the gateway.

If the IPv6 gateway address is not link-local, system ignores the next hop VLAN for the gateway.

■ Buttons**Add Interface:**

Click to add a new IP interface. A maximum of 8 interfaces is supported.

Add Route:

Click to add a new IP route. A maximum of 8 routes is supported.

Apply:

Click to save changes.

Reset:

Click to undo any changes made locally and revert to previously saved values.

Status

IP Status

This page displays the status of the IP protocol layer. The status is defined by the IP interfaces, the IP routes and the neighbor cache (ARP cache) status.

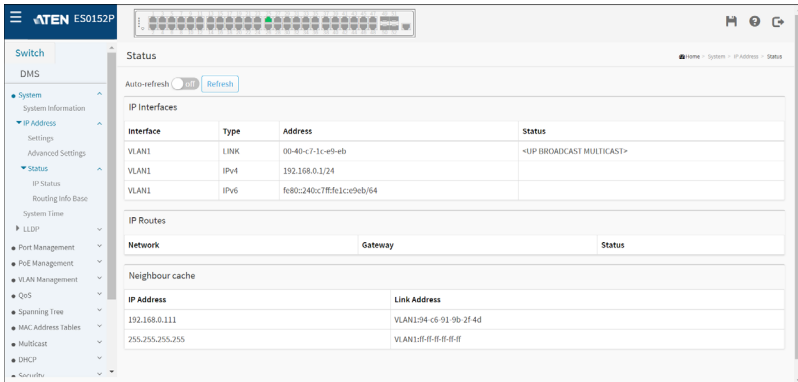

To display the log configuration in the web interface:

1. Click System, IP Address and Status.
2. Display the IP Configuration information.

■ Parameter description:

IP Interface

Interface:

Show the name of the interface.

Type:

Show the address type of the entry. This may be LINK or IPv4.

Address:

Show the current address of the interface (of the given type).

Status:

Show the status flags of the interface (and/or address).

IP Routes

Network:

Show the destination IP network or host address of this route.

Gateway:

Show the gateway address of this route.

Status:

Show the status flags of the route.

Neighbor cache

IP Address:

Show the IP address of the entry.

Link Address:

Show the Link (MAC) address for which a binding to the IP address given exist.

■ **Buttons**

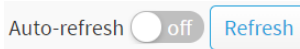

Auto-refresh:

Check this box to refresh the page automatically. Automatic refresh occurs every 3 seconds.

Refresh:

Click to refresh the page immediately.

Routing Info Base

Navigating the Routing Information Base Table

Each page shows up to 999 table entries, selected through the “entries per page” input field. When first visited, the web page will show the beginning entries of this table.

The “Start from ID” input field allow the user to change the starting point in this table. Clicking the Refresh button will update the displayed table starting from that or the closest next entry match. In addition, these input fields will upon a Refresh button click - assume the value of the first displayed entry, allowing for continuous refresh with the same start input field.

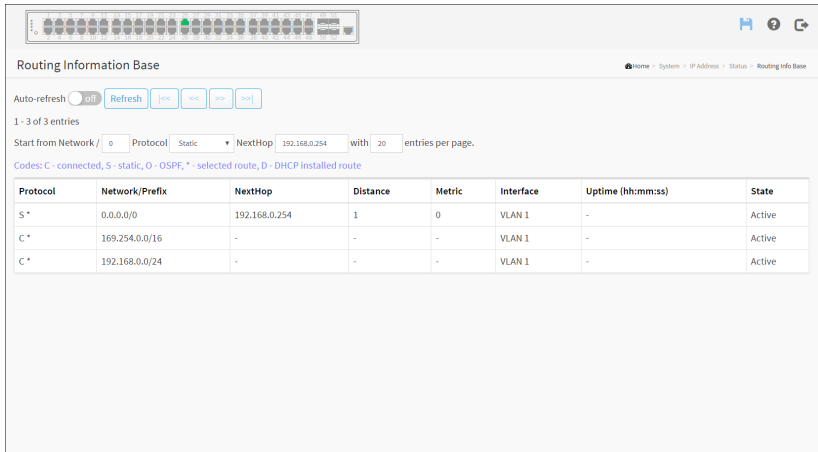

Routing Information Base

Home > System > IP Address > Status > Routing Info Base

Auto-refresh: Refresh << < > >>

1 - 3 of 3 entries

Start from Network / 0 Protocol Static NextHop 192.168.0.254 with 20 entries per page.

Codes: C - connected, S - static, O - OSPF, * - selected route, D - DHCP installed route

Protocol	Network/Prefix	NextHop	Distance	Metric	Interface	Uptime (hh:mm:ss)	State
S*	0.0.0.0/0	192.168.0.254	1	0	VLAN 1	-	Active
C*	169.254.0.0/16	-	-	-	VLAN 1	-	Active
C*	192.168.0.0/24	-	-	-	VLAN 1	-	Active

Web Interface

To display the routing information in the web interface:

1. Click System, IP Address, Status and Routing Info Base.
2. Display the Routing Base information.

■ Parameter description:

DHCP:

The route is created by DHCP.

Connected:

The destination network is connected directly.

Static:

The route is created by user.

OSPF:

The route is created by OSPF.

Network/Prefix:

Network and prefix (example 10.0.0.0/16) of the given route entry.

NextHop:

The IP address of nexthop. Value '0.0.0.0' indicates the link is directly connected.

Distance:

The distance of the route.

Metric:

The metric of the route.

Interface:

The interface where the ip packet is outgoing.

Uptime (hh:ss:mm):

The time till the route is created. The unit is second.

State:

Indicate if the destination network is reachable or not.

■ Buttons



Auto-refresh:

Check this box to refresh the page automatically. Automatic refresh occurs every 3 seconds.

Refresh:

Click to refresh the page immediately.

|<< :

Updates the table entries, starting from the first available entry. If the first entry of the table is displayed, the button is disabled

<< :

Updates the table entries, ending at the entry prior to the first entry currently displayed. If the first entry of the table is displayed, the button is disabled

>> :

Updates the table entries, starting from the entry next to the last entry currently displayed.

If the last entry of the table is displayed, the button is disabled.

>>| :

Updates the table entries, ending at the last available entry. If the last entry of the table is displayed, the button is disabled.

System Time

The switch provides manual and automatic ways to set the system time via NTP. Manual setting is simple and you just input “Year”, “Month”, “Day”, “Hour” and “Minute” within the valid value range indicated in each item.

The screenshot displays the 'Time Configuration' web interface. It is divided into several sections:

- Time Configuration:** Includes a 'Clock Source' dropdown set to 'Use Local Settings' and a 'System Date' field showing '2016-01-01 02:04:01' with a '(yyyy-mm-dd hh:mm:ss)' format hint. A 'Configure NTP Server' button is visible on the right.
- Time Zone Configuration:** Features a 'Time Zone' dropdown set to 'None' and an 'Acronym' text input field with a '(0 - 16 characters)' hint.
- Daylight Saving Time Configuration:** Shows 'Daylight Saving Time' set to 'Disabled'. It contains two sub-sections:
 - Start Time settings:** Fields for Month (Jan), Date (1), Year (2014), Hours (0), and Minutes (0).
 - End Time settings:** Fields for Month (Jan), Date (1), Year (2097), Hours (0), and Minutes (0).
- Offset settings:** An 'Offset' field set to '1' with a '(1 - 1440) Minutes' hint.

At the bottom right, there are 'Reset' and 'Apply' buttons.

To configure Time in the web interface:

1. Click System and System Time
2. Specify the Time parameter.
3. Click Apply.

■ Parameter description:

Time Configuration

Clock Source:

There are two modes for configuring how the Clock Source from. Select “Local Settings”: Clock Source from Local Time. Select “NTP Server” : Clock Source from NTP Server.

System Date:

Show the current time of the system. The year of system date limits between 2000 and 2037.

Time Zone Configuration

Time Zone:

Lists various Time Zones worldwide. Select appropriate Time Zone from the drop down and click Apply to set.

Acronym:

User can set the acronym of the time zone. This is a User configurable acronym to identify the time zone. (Range: Up to 16 characters)

Daylight Saving Time Configuration

Daylight Saving Time:

This is used to set the clock forward or backward according to the configurations set below for a defined Daylight Saving Time duration. Select 'Disable' to disable the Daylight Saving Time configuration. Select 'Recurring' and configure the Daylight Saving Time duration to repeat the configuration every year. Select 'Non-Recurring' and configure the Daylight Saving Time duration for single time configuration. (Default: Disabled).

Recurring Configuration

Start time settings:

Week - Select the starting week number.

Day - Select the starting day.

Month - Select the starting month.

Hours - Select the starting hour.

Minutes - Select the starting minute.

End time settings:

Week - Select the ending week number.

Day - Select the ending day.

Month - Select the ending month.

Hours - Select the ending hour.

Minutes - Select the starting minute.

Offset settings:

Offset - Enter the number of minutes to add during Daylight Saving Time.
(Range: 1 to 1440)

Note: The under “Start Time Settings” and “End Time Settings” was displayed what you set on the “Start Time Settings” and “End Time Settings” field information.

■ Buttons

Apply:

Click to save changes.

Reset:

Click to undo any changes made locally and revert to previously saved values.

Configure NTP Server:

Time Configuration

Clock Source: Use NTP Server Configure NTP Server

System Date: 2016-02-01 01:36:15 (yyyy-mm-dd hh:mm:ss)

NTP Configuration Home - System - System Time

NTP Time-Sync Interval	
60	
Server 1	<input type="text"/>
Server 2	<input type="text"/>
Server 3	<input type="text"/>
Server 4	<input type="text"/>
Server 5	<input type="text"/>

Reset Apply

Click to configure NTP server, When Clock Source select from NTP Server. NTP is Network Time Protocol and is used to sync the network time based Greenwich Mean Time (GMT). If use the NTP mode and select a built-in NTP time server or manually specify an user-defined NTP server as well as Time Zone, the switch will sync the time in a short after pressing <Apply> button.

Though it synchronizes the time automatically, NTP does not update the time periodically without user's processing.

Time Zone is an offset time of GMT. You have to select the time zone first and then perform time sync via NTP because the switch will combine this time zone offset and updated NTP time to come out the local time, otherwise, you will not able to get the correct time. The switch supports configurable time zone from -12 to +13 step 1 hour.

Default Time zone: +8 Hrs.

■ **Parameter description:**

Server 1 to 5:

Provide the NTP IPv4 or IPv6 address of this switch. IPv6 address is in 128-bit records represented as eight fields of up to four hexadecimal digits with a colon separating each field (:). For example, 'fe80::215:c5ff:fe03:4dc7'. The symbol '::' is a special syntax that can be used as a shorthand way of representing multiple 16-bit groups of contiguous zeros; but it can only appear once. It can also represent a legally valid IPv4 address. For example, ':::192.1.2.34'.

■ **Buttons**

These buttons are displayed on the SNTP page:

Apply:

Click to save changes.

Reset:

Click to undo any changes made locally and revert to previously saved values.

LLDP

The switch supports the LLDP. For current information on your switch model, The Link Layer Discovery Protocol (LLDP) provides a standards-based method for enabling switches to advertise themselves to adjacent devices and to learn about adjacent LLDP devices. The Link Layer Discovery Protocol (LLDP) is a vendor-neutral Link Layer protocol in the Internet Protocol Suite used by network devices for advertising their identity, capabilities, and neighbors on a IEEE 802 local area network, principally wired Ethernet. The protocol is formally referred to by the IEEE as Station and Media Access Control Connectivity Discovery specified in standards document IEEE 802.1AB.

LLDP Configuration

You can per port to do the LLDP configuration and the detail parameters, the settings will take effect immediately. This page allows the user to inspect and configure the current LLDP port settings.

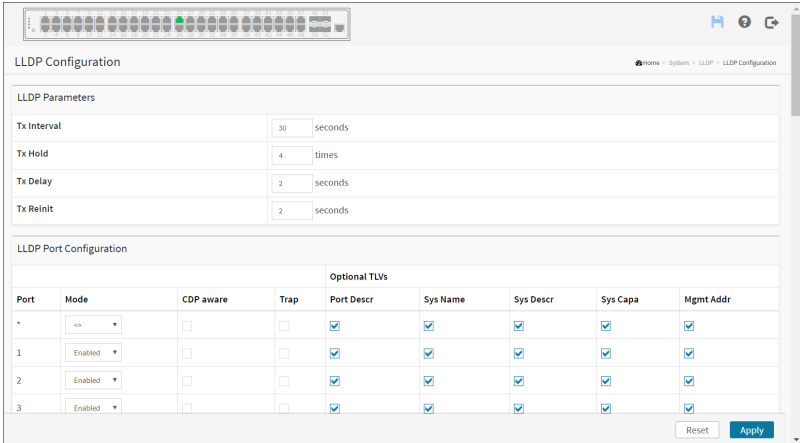

The screenshot shows the LLDP Configuration web interface. It includes a breadcrumb trail: Home > System > LLDP > LLDP Configuration. The interface is divided into two main sections: LLDP Parameters and LLDP Port Configuration.

LLDP Parameters

Tx Interval	30	seconds
Tx Hold	4	times
Tx Delay	2	seconds
Tx Reinit	2	seconds

LLDP Port Configuration

Port	Mode	CDP aware	Trap	Optional TLVs				
				Port Descr	Sys Name	Sys Descr	Sys Capa	Mgmt Addr
*	<=>	<input type="checkbox"/>	<input type="checkbox"/>	<input checked="" type="checkbox"/>	<input checked="" type="checkbox"/>	<input checked="" type="checkbox"/>	<input checked="" type="checkbox"/>	<input checked="" type="checkbox"/>
1	Enabled	<input type="checkbox"/>	<input type="checkbox"/>	<input checked="" type="checkbox"/>	<input checked="" type="checkbox"/>	<input checked="" type="checkbox"/>	<input checked="" type="checkbox"/>	<input checked="" type="checkbox"/>
2	Enabled	<input type="checkbox"/>	<input type="checkbox"/>	<input checked="" type="checkbox"/>	<input checked="" type="checkbox"/>	<input checked="" type="checkbox"/>	<input checked="" type="checkbox"/>	<input checked="" type="checkbox"/>
3	Enabled	<input type="checkbox"/>	<input type="checkbox"/>	<input checked="" type="checkbox"/>	<input checked="" type="checkbox"/>	<input checked="" type="checkbox"/>	<input checked="" type="checkbox"/>	<input checked="" type="checkbox"/>

Buttons: Reset, Apply

Web Interface

To configure LLDP:

1. Click System, LLDP and LLDP configuration.
2. Modify LLDP timing parameters.
3. Set the required mode for transmitting or receiving LLDP messages.

4. Specify the information to include in the TLV field of advertised messages.
5. Click Apply.

■ Parameter description:

LLDP Parameters

Tx Interval:

The switch periodically transmits LLDP frames to its neighbors for having the network discovery information up-to-date. The interval between each LLDP frame is determined by the Tx Interval value. Valid values are restricted to 5 - 32768 seconds.

Tx Hold:

Each LLDP frame contains information about how long the information in the LLDP frame shall be considered valid. The LLDP information valid period is set to Tx Hold multiplied by Tx Interval seconds. Valid values are restricted to 2 - 10 times.

Tx Delay:

If some configuration is changed (e.g. the IP address) a new LLDP frame is transmitted, but the time between the LLDP frames will always be at least the value of Tx Delay seconds. Tx Delay cannot be larger than 1/4 of the Tx Interval value. Valid values are restricted to 1 - 8192 seconds.

Tx Reinit:

When a port is disabled, LLDP is disabled or the switch is rebooted, an LLDP shutdown frame is transmitted to the neighboring units, signaling that the LLDP information isn't valid anymore. Tx Reinit controls the amount of seconds between the shutdown frame and a new LLDP initialization. Valid values are restricted to 1 - 10 seconds.

LLDP Port Configuration

The LLDP port settings relate to the currently selected, as reflected by the page header.

Port:

The switch port number of the logical LLDP port.

Mode:

Select LLDP mode.

Rx only: The switch will not send out LLDP information, but LLDP information from neighbor units is analyzed.

Tx only: The switch will drop LLDP information received from neighbors, but will send out LLDP information.

Disabled: The switch will not send out LLDP information, and will drop LLDP information received from neighbors.

Enabled: the switch will send out LLDP information, and will analyze LLDP information received from neighbors.

CDP Aware:

Select CDP awareness.

The CDP operation is restricted to decode incoming CDP frames (The switch doesn't transmit CDP frames). CDP frames are only decoded if LLDP on the port is enabled.

Only CDP TLVs that can be mapped to a corresponding field in the LLDP neighbors' table are decoded. All other TLVs are discarded (Unrecognized CDP TLVs and discarded CDP frames are not shown in the LLDP statistics.). CDP TLVs are mapped onto LLDP neighbors' table as shown below.

CDP TLV "Device ID" is mapped to the LLDP "Chassis ID" field.

CDP TLV "Address" is mapped to the LLDP "Management Address" field. The CDP address TLV can contain multiple addresses, but only the first address is shown in the LLDP neighbors' table.

CDP TLV "Port ID" is mapped to the LLDP "Port ID" field.

CDP TLV "Version and Platform" is mapped to the LLDP "System Description" field.

Both the CDP and LLDP support "system capabilities", but the CDP capabilities cover capabilities that are not part of the LLDP. These capabilities are shown as "others" in the LLDP neighbors' table.

If all ports have CDP awareness disabled the switch forwards CDP frames received from neighbor devices. If at least one port has CDP awareness enabled all CDP frames are terminated by the switch.

Note: When CDP awareness on a port is disabled the CDP information isn't removed immediately, but gets when the hold time is exceeded.

Trap:

LLDP trapping notifies events such as newly-detected neighboring devices and link malfunctions.

Port Descr:

Optional TLV: When checked the "port description" is included in LLDP information transmitted.

Sys Name:

Optional TLV: When checked the "system name" is included in LLDP information transmitted.

Sys Descr:

Optional TLV: When checked the "system description" is included in LLDP information transmitted.

Sys Capa:

Optional TLV: When checked the "system capability" is included in LLDP information transmitted.

Mgmt Addr:

Optional TLV: When checked the "management address" is included in LLDP information transmitted.

■ Buttons

Apply:

Click to save changes.

Reset:

Click to undo any changes made locally and revert to previously saved values.

LLDP-MED Configuration

Media Endpoint Discovery is an enhancement of LLDP, known as LLDP-MED that provides the following facilities:

Auto-discovery of LAN policies (such as VLAN, Layer 2 Priority and Differentiated services (Diffserv) settings) enabling plug and play networking.

Device location discovery to allow creation of location databases and, in the case of Voice over Internet Protocol (VoIP), Enhanced 911 services.

Extended and automated power management of Power over Ethernet (PoE) end points.

Inventory management, allowing network administrators to track their network devices, and determine their characteristics (manufacturer, software and hardware versions, and serial or asset number).

This page allows you to configure the LLDP-MED. This function applies to VoIP devices which support LLDP-MED.

LLDP-MED Configuration Home > System > LLDP > LLDP-MED Configuration

Fast Start Repeat Count

Fast start repeat count

Transmit TLVs

Port	Capabilities	Policies	Location	PoE	Device Type
*	<input checked="" type="checkbox"/>	<input checked="" type="checkbox"/>	<input checked="" type="checkbox"/>	<input checked="" type="checkbox"/>	-->
1	<input checked="" type="checkbox"/>	<input checked="" type="checkbox"/>	<input checked="" type="checkbox"/>	<input checked="" type="checkbox"/>	Connectivity
2	<input checked="" type="checkbox"/>	<input checked="" type="checkbox"/>	<input checked="" type="checkbox"/>	<input checked="" type="checkbox"/>	Connectivity
3	<input checked="" type="checkbox"/>	<input checked="" type="checkbox"/>	<input checked="" type="checkbox"/>	<input checked="" type="checkbox"/>	Connectivity
4	<input checked="" type="checkbox"/>	<input checked="" type="checkbox"/>	<input checked="" type="checkbox"/>	<input checked="" type="checkbox"/>	Connectivity
5	<input checked="" type="checkbox"/>	<input checked="" type="checkbox"/>	<input checked="" type="checkbox"/>	<input checked="" type="checkbox"/>	Connectivity
49	<input checked="" type="checkbox"/>	<input checked="" type="checkbox"/>	<input checked="" type="checkbox"/>	<input checked="" type="checkbox"/>	Connectivity
50	<input checked="" type="checkbox"/>	<input checked="" type="checkbox"/>	<input checked="" type="checkbox"/>	<input checked="" type="checkbox"/>	Connectivity
51	<input checked="" type="checkbox"/>	<input checked="" type="checkbox"/>	<input checked="" type="checkbox"/>	<input checked="" type="checkbox"/>	Connectivity
52	<input checked="" type="checkbox"/>	<input checked="" type="checkbox"/>	<input checked="" type="checkbox"/>	<input checked="" type="checkbox"/>	Connectivity

Coordinates Location

Latitude North Longitude East

Altitude Meters Map Datum

Civic Address Location

Country code	<input type="text"/>	State/Province	<input type="text"/>	County	<input type="text"/>
City	<input type="text"/>	City district	<input type="text"/>	Block (Neighborhood)	<input type="text"/>
Street	<input type="text"/>	Leading street direction	<input type="text"/>	Trailing street suffix	<input type="text"/>
Street suffix	<input type="text"/>	House no.	<input type="text"/>	House no. suffix	<input type="text"/>
Landmark	<input type="text"/>	Additional location info	<input type="text"/>	Name	<input type="text"/>
Zip code	<input type="text"/>	Building	<input type="text"/>	Apartment	<input type="text"/>
Floor	<input type="text"/>	Room no.	<input type="text"/>	Place type	<input type="text"/>
Postal community name	<input type="text"/>	P.O. Box	<input type="text"/>	Additional code	<input type="text"/>

Emergency Call Service

Emergency Call Service

Policies

Delete	Policy ID	Application Type	Tag	VLAN ID	L2 Priority	DSCP
No entries present						

[Add New Policy](#)

Web Interface

To configure LLDP-MED:

1. Click System, LLDP and LLDP-MED Configuration.

2. Modify Fast start repeat count parameter, default is 4.
3. Modify Transmit TLVs parameters.
4. Modify Coordinates Location parameters.
5. Fill Civic Address Location parameters.
6. Fill Emergency Call Service parameters.
7. Add new policy.
8. Click Apply, will show following Policy Port Configuration.
9. Select Policy ID for each port.
10. Click Apply.

■ **Parameter description:**

Fast start repeat count

Rapid startup and Emergency Call Service Location Identification Discovery of endpoints is a critically important aspect of VoIP systems in general. In addition, it is best to advertise only those pieces of information which are specifically relevant to particular endpoint types (for example only advertise the voice network policy to permitted voice-capable devices), both in order to conserve the limited LLDPDU space and to reduce security and system integrity issues that can come with inappropriate knowledge of the network policy.

With this in mind LLDP-MED defines an LLDP-MED Fast Start interaction between the protocol and the application layers on top of the protocol, in order to achieve these related properties. Initially, a Network Connectivity Device will only transmit LLDP TLVs in an LLDPDU. Only after an LLDP-MED Endpoint Device is detected, will an LLDP-MED capable Network Connectivity Device start to advertise LLDP-MED TLVs in outgoing LLDPDUs on the associated port. The LLDP-MED application will temporarily speed up the transmission of the LLDPDU to start within a second, when a new LLDP-MED neighbor has been detected in order share LLDP-MED information as fast as possible to new neighbors.

Because there is a risk of an LLDP frame being lost during transmission between neighbors, it is recommended to repeat the fast start transmission multiple times to increase the possibility of the neighbors receiving the LLDP frame. With Fast start repeat count it is possible to specify the number of times the fast start transmission would be repeated. The recommended value is 4 times, given that 4 LLDP frames with a 1 second interval will be transmitted, when an LLDP frame with new information is received.

It should be noted that LLDP-MED and the LLDP-MED Fast Start mechanism is only intended to run on links between LLDP-MED Network Connectivity Devices and Endpoint Devices, and as such does not apply to links between LAN infrastructure elements, including Network Connectivity Devices, or other types of links.

Transmit TLVs

Port:

The interface name to which the configuration applies.

Capabilities:

When checked the switch's capabilities is included in LLDP-MED information transmitted.

Policies:

When checked the configured policies for the interface is included in LLDP-MED information transmitted.

Location:

When checked the configured location information for the switch is included in LLDP-MED information transmitted.

PoE:

When checked the configured PoE (Power Over Ethernet) information for the interface is included in LLDP-MED information transmitted.

Device Type:

Any LLDP-MED Device is operating as a specific type of LLDP-MED Device, which may be either a Network Connectivity Device or a specific Class of Endpoint Device, as defined below.

A Network Connectivity Device is a LLDP-MED Device that provides access to the IEEE 802 based LAN infrastructure for LLDP-MED Endpoint Devices

An LLDP-MED Network Connectivity Device is a LAN access device based on any of the following technologies :

1. LAN Switch/Router
2. IEEE 802.1 Bridge
3. IEEE 802.3 Repeater (included for historical reasons)
4. IEEE 802.11 Wireless Access Point

5. Any device that supports the IEEE 802.1AB and MED extensions that can relay IEEE 802 frames via any method.

An Endpoint Device a LLDP-MED Device that sits at the network edge and provides some aspect of IP communications service, based on IEEE 802 LAN technology.

The main difference between a Network Connectivity Device and an Endpoint Device is that only an Endpoint Device can start the LLDP-MED information exchange.

Even though a switch always should be a Network Connectivity Device, it is possible to configure it to act as an Endpoint Device, and thereby start the LLDP-MED information exchange (In the case where two Network Connectivity Devices are connected together)

Coordinates Location

Latitude:

Latitude SHOULD be normalized to within 0-90 degrees with a maximum of 4 digits.

It is possible to specify the direction to either North of the equator or South of the equator.

Longitude:

Longitude SHOULD be normalized to within 0-180 degrees with a maximum of 5 digits.

It is possible to specify the direction to either East of the prime meridian or West of the prime meridian.

Altitude:

Altitude SHOULD be normalized to within -32767 to 32767 with a maximum of 4 digits.

It is possible to select between two altitude types (floors or meters).

Meters: Representing meters of Altitude defined by the vertical datum specified.

Floors: Representing altitude in a form more relevant in buildings which have different floor-to-floor dimensions. An altitude = 0.0 is meaningful even outside a building, and represents ground level at the given latitude and longitude. Inside a building, 0.0 represents the floor level associated with ground level at the main entrance.

Map Datum:

The Map Datum is used for the coordinates given in these options:

WGS84: (Geographical 3D) - World Geodesic System 1984, CRS Code 4327, and Prime Meridian Name: Greenwich.

NAD83/NAVD88: North American Datum 1983, CRS Code 4269, Prime Meridian Name: Greenwich; the associated vertical datum is the North American Vertical Datum of 1988 (NAVD88). This datum pair is to be used when referencing locations on land, not near tidal water (which would use Datum = NAD83/MLLW).

NAD83/MLLW: North American Datum 1983, CRS Code 4269, Prime Meridian Name: Greenwich; the associated vertical datum is Mean Lower Low Water (MLLW). This datum pair is to be used when referencing locations on water/sea/ocean.

Civic Address Location

IETF Geopriv Civic Address based Location Configuration Information (Civic Address LCI).

Country code:

The two-letter ISO 3166 country code in capital ASCII letters - Example: DK, DE or US.

State/Province:

National subdivisions (state, canton, region, province, prefecture).

County:

County, parish, gun (Japan), district.

City:

City, township, shi (Japan) - Example: Copenhagen.

City district:

City division, borough, city district, ward, chou (Japan).

Block (neighborhood):

neighborhood, block.

Street:

Street - Example: Poppelvej.

Leading street direction:

Leading street direction - Example: N.

Trailing street suffix:

Trailing street suffix - Example: SW.

Street suffix:

Street suffix - Example: Ave, Platz.

House no.:

House number - Example: 21.

House no. suffix:

House number suffix - Example: A, 1/2.

Landmark:

Landmark or vanity address - Example: Columbia University.

Additional location info:

Additional location info - Example: South Wing.

Name:

Name (residence and office occupant) - Example: Flemming Jahn.

Zip code:

Postal/zip code - Example: 2791.

Building:

Building (structure) - Example: Low Library.

Apartment:

Unit (Apartment, suite) - Example: Apt 42.

Floor:

Floor - Example: 4.

Room no.:

Room number - Example: 450F.

Place type:

Place type - Example: Office.

Postal community name:

Postal community name - Example: Leonia.

P.O. Box:

Post office box (P.O. BOX) - Example: 12345.

Additional code:

Additional code - Example: 1320300003.

Emergency Call Service:

Emergency Call Service (e.g. E911 and others), such as defined by TIA or NENA.

Emergency Call Service:

Emergency Call Service ELIN identifier data format is defined to carry the ELIN identifier as used during emergency call setup to a traditional CAMA or ISDN trunk-based PSAP. This format consists of a numerical digit string, corresponding to the ELIN to be used for emergency calling.

Policies

Network Policy Discovery enables the efficient discovery and diagnosis of mismatch issues with the VLAN configuration, along with the associated Layer 2 and Layer 3 attributes, which apply for a set of specific protocol applications on that port. Improper network policy configurations are a very significant issue in VoIP environments that frequently result in voice quality degradation or loss of service.

Policies are only intended for use with applications that have specific 'real-time' network policy requirements, such as interactive voice and/or video services.

The network policy attributes advertised are:

1. Layer 2 VLAN ID (IEEE 802.1Q-2003)
2. Layer 2 priority value (IEEE 802.1D-2004)
3. Layer 3 Diffserv code point (DSCP) value (IETF RFC 2474)

This network policy is potentially advertised and associated with multiple sets of application types supported on a given port. The application types specifically addressed are:

1. Voice
2. Guest Voice
3. Softphone Voice

4. Video Conferencing

5. Streaming Video

6. Control / Signalling (conditionally support a separate network policy for the media types above)

A large network may support multiple VoIP policies across the entire organization, and different policies per application type. LLDP-MED allows multiple policies to be advertised per port, each corresponding to a different application type. Different ports on the same Network Connectivity Device may advertise different sets of policies, based on the authenticated user identity or port configuration.

It should be noted that LLDP-MED is not intended to run on links other than between Network Connectivity Devices and Endpoints, and therefore does not need to advertise the multitude of network policies that frequently run on an aggregated link interior to the LAN.

Delete:

Check to delete the policy. It will be deleted during the next save.

Policy ID:

ID for the policy. This is auto generated and shall be used when selecting the policies that shall be mapped to the specific ports.

Application Type:

Intended use of the application types:

1. Voice - for use by dedicated IP Telephony handsets and other similar appliances supporting interactive voice services. These devices are typically deployed on a separate VLAN for ease of deployment and enhanced security by isolation from data applications.
2. Voice Signalling (conditional) - for use in network topologies that require a different policy for the voice signalling than for the voice media. This application type should not be advertised if all the same network policies apply as those advertised in the Voice application policy.
3. Guest Voice - support a separate 'limited feature-set' voice service for guest users and visitors with their own IP Telephony handsets and other similar appliances supporting interactive voice services.
4. Guest Voice Signalling (conditional) - for use in network topologies that require a different policy for the guest voice signalling than for the guest voice

media. This application type should not be advertised if all the same network policies apply as those advertised in the Guest Voice application policy.

5. Softphone Voice - for use by softphone applications on typical data centric devices, such as PCs or laptops. This class of endpoints frequently does not support multiple VLANs, if at all, and are typically configured to use an 'untagged' VLAN or a single 'tagged' data specific VLAN. When a network policy is defined for use with an 'untagged' VLAN (see Tagged flag below), then the L2 priority field is ignored and only the DSCP value has relevance.

6. Video Conferencing - for use by dedicated Video Conferencing equipment and other similar appliances supporting real-time interactive video/audio services.

7. Streaming Video - for use by broadcast or multicast based video content distribution and other similar applications supporting streaming video services that require specific network policy treatment. Video applications relying on TCP with buffering would not be an intended use of this application type.

8. Video Signalling (conditional) - for use in network topologies that require a separate policy for the video signalling than for the video media. This application type should not be advertised if all the same network policies apply as those advertised in the Video Conferencing application policy.

Tag:

Tag indicating whether the specified application type is using a 'tagged' or an 'untagged' VLAN.

Untagged indicates that the device is using an untagged frame format and as such does not include a tag header as defined by IEEE 802.1Q-2003. In this case, both the VLAN ID and the Layer 2 priority fields are ignored and only the DSCP value has relevance.

Tagged indicates that the device is using the IEEE 802.1Q tagged frame format, and that both the VLAN ID and the Layer 2 priority values are being used, as well as the DSCP value. The tagged format includes an additional field, known as the tag header. The tagged frame format also includes priority tagged frames as defined by IEEE 802.1Q-2003.

VLAN ID:

VLAN identifier (VID) for the port as defined in IEEE 802.1Q-2003.

L2 Priority:

L2 Priority is the Layer 2 priority to be used for the specified application type. L2 Priority may specify one of eight priority levels (0 through 7), as defined by

IEEE 802.1D-2004. A value of 0 represents use of the default priority as defined in IEEE 802.1D-2004.

DSCP:

DSCP value to be used to provide Diffserv node behaviour for the specified application type as defined in IETF RFC 2474. DSCP may contain one of 64 code point values (0 through 63). A value of 0 represents use of the default DSCP value as defined in RFC 2475.

Port Policies Configuration:

Every port may advertise a unique set of network policies or different attributes for the same network policies, based on the authenticated user identity or port configuration.

Port:

The port number to which the configuration applies.

Policy Id:

The set of policies that shall apply to a given port. The set of policies is selected by check marking the checkboxes that corresponds to the policies.

Buttons

Adding New Policy:

Click to add a new policy. Specify the Application type, Tag, VLAN ID, L2 Priority and DSCP for the new policy. Click "Apply".

Apply:

Click to save changes.

Reset:

Click to undo any changes made locally and revert to previously saved values.

LLDP Neighbor

This page provides a status overview for all LLDP neighbors. The displayed table contains a row for each port on which an LLDP neighbor is detected. The columns hold the following information:

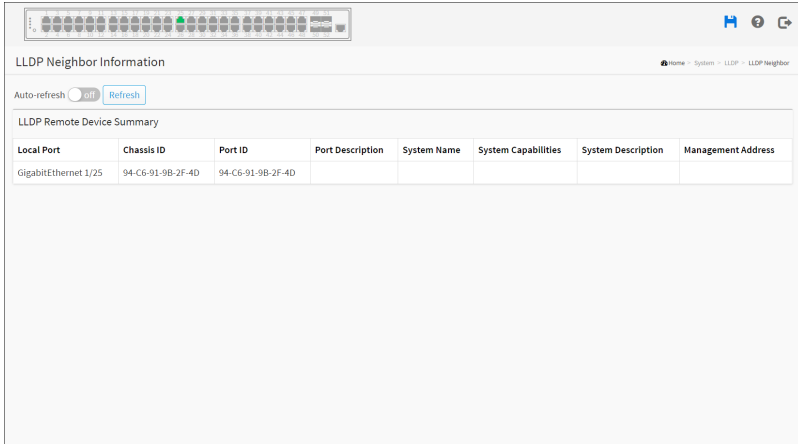

Web Interface

To show LLDP neighbors:

1. Click System, LLDP and LLDP neighbor.
2. Click Refresh for manual update web screen.
3. Click Auto-refresh for auto-update web screen.

Note: If there is no device that supports LLDP in your network then the table will show “No LLDP neighbor information found”.

■ Parameter description:

Local Port:

The port on which the LLDP frame was received.

Chassis ID:

The Chassis ID is the identification of the neighbor's LLDP frames.

Port ID:

The Remote Port ID is the identification of the neighbor port.

Port Description:

Port Description is the port description advertised by the neighbor unit.

System Name:

System Name is the name advertised by the neighbor unit.

System Capabilities:

System Capabilities describes the neighbor unit's capabilities. The possible capabilities are:

1. Other
2. Repeater
3. Bridge
4. WLAN Access Point
5. Router
6. Telephone
7. DOCSIS cable device
8. Station only
9. Reserved

When a capability is enabled, the capability is followed by (+). If the capability is disabled, the capability is followed by (-).

System Description

Displays the system description.

Management Address:

Management Address is the neighbor unit's address that is used for higher layer entities to assist discovery by the network management. This could for instance hold the neighbor's IP address.

■ Buttons



Auto-refresh:

Check this box to refresh the page automatically. Automatic refresh occurs every 3 seconds.

Refresh:

Click to refresh the page immediately.

LLDP-MED Neighbor

This page provides a status overview of all LLDP-MED neighbors. The displayed table contains a row for each port on which an LLDP neighbor is detected. This function applies to VoIP devices which support LLDP-MED. The columns hold the following information:

Device Type	Capabilities		
Endpoint Class I	LLDP-MED Capabilities		
Auto-negotiation	Auto-negotiation status	Auto-negotiation Capabilities	MAU Type
Supported	Enabled	1000BASE-T full duplex mode	Invalid MAU Type

Web Interface

To show LLDP-MED neighbor:

1. Click System, LLDP and LLDP-MED Neighbor.
2. Click Refresh for manual update web screen.
3. Click Auto-refresh for auto-update web screen.

■ Parameter description

Port:

The port on which the LLDP frame was received.

Device Type:

LLDP-MED Devices are comprised of two primary Device Types: Network Connectivity Devices and Endpoint Devices.

◆ LLDP-MED Network Connectivity Device Definition

LLDP-MED Network Connectivity Devices, as defined in TIA-1057, provide access to the IEEE 802 based LAN infrastructure for LLDP-MED Endpoint Devices. An LLDP-MED Network Connectivity Device is a LAN access device based on any of the following technologies:

1. LAN Switch/Router
2. IEEE 802.1 Bridge
3. IEEE 802.3 Repeater (included for historical reasons)
4. IEEE 802.11 Wireless Access Point
5. Any device that supports the IEEE 802.1AB and MED extensions defined by TIA-1057 and can relay IEEE 802 frames via any method.

- ◆ LLDP-MED Endpoint Device Definition

LLDP-MED Endpoint Devices, as defined in TIA-1057, are located at the IEEE 802 LAN network edge, and participate in IP communication service using the LLDP-MED framework.

Within the LLDP-MED Endpoint Device category, the LLDP-MED scheme is broken into further Endpoint Device Classes, as defined in the following.

Each LLDP-MED Endpoint Device Class is defined to build upon the capabilities defined for the previous Endpoint Device Class. For-example will any LLDP-MED Endpoint Device claiming compliance as a Media Endpoint (Class II) also support all aspects of TIA-1057 applicable to Generic Endpoints (Class I), and any LLDP-MED Endpoint Device claiming compliance as a Communication Device (Class III) will also support all aspects of TIA-1057 applicable to both Media Endpoints (Class II) and Generic Endpoints (Class I).

- ◆ LLDP-MED Generic Endpoint (Class I):

The LLDP-MED Generic Endpoint (Class I) definition is applicable to all endpoint products that require the base LLDP discovery services defined in TIA-1057, however do not support IP media or act as an end-user communication appliance. Such devices may include (but are not limited to) IP Communication Controllers, other communication related servers, or any device requiring basic services as defined in TIA-1057.

Discovery services defined in this class include LAN configuration, device location, network policy, power management, and inventory management.

- ◆ LLDP-MED Media Endpoint (Class II):

The LLDP-MED Media Endpoint (Class II) definition is applicable to all endpoint products that have IP media capabilities however may or may not be associated with a particular end user. Capabilities include all of the capabilities defined for the previous Generic Endpoint Class (Class I), and are extended to include aspects related to media streaming. Example

product categories expected to adhere to this class include (but are not limited to) Voice / Media Gateways, Conference Bridges, Media Servers, and similar.

Discovery services defined in this class include media-type-specific network layer policy discovery.

- ◆ LLDP-MED Communication Endpoint (Class III):

The LLDP-MED Communication Endpoint (Class III) definition is applicable to all endpoint products that act as end user communication appliances supporting IP media. Capabilities include all of the capabilities defined for the previous Generic Endpoint (Class I) and Media Endpoint (Class II) classes, and are extended to include aspects related to end user devices. Example product categories expected to adhere to this class include (but are not limited to) end user communication appliances, such as IP Phones, PC-based softphones, or other communication appliances that directly support the end user.

Discovery services defined in this class include provision of location identifier (including ECS / E911 information), embedded L2 switch support, inventory management.

LLDP-MED Capabilities:

LLDP-MED Capabilities describes the neighborhood unit's LLDP-MED capabilities. The possible capabilities are:

1. LLDP-MED capabilities
2. Network Policy
3. Location Identification
4. Extended Power via MDI - PSE
5. Extended Power via MDI - PD
6. Inventory
7. Reserved

Application Type:

Application Type indicating the primary function of the application(s) defined for this network policy, advertised by an Endpoint or Network Connectivity Device. The possible application types are shown below.

1. Voice - for use by dedicated IP Telephony handsets and other similar appliances supporting interactive voice services. These devices are typically

deployed on a separate VLAN for ease of deployment and enhanced security by isolation from data applications.

2. Voice Signalling - for use in network topologies that require a different policy for the voice signalling than for the voice media.
3. Guest Voice - to support a separate limited feature-set voice service for guest users and visitors with their own IP Telephony handsets and other similar appliances supporting interactive voice services.
4. Guest Voice Signalling - for use in network topologies that require a different policy for the guest voice signalling than for the guest voice media.
5. Softphone Voice - for use by softphone applications on typical data centric devices, such as PCs or laptops.
6. Video Conferencing - for use by dedicated Video Conferencing equipment and other similar appliances supporting real-time interactive video/audio services.
7. Streaming Video - for use by broadcast or multicast based video content distribution and other similar applications supporting streaming video services that require specific network policy treatment. Video applications relying on TCP with buffering would not be an intended use of this application type.
8. Video Signalling - for use in network topologies that require a separate policy for the video signalling than for the video media.

Policy:

Policy indicates that an Endpoint Device wants to explicitly advertise that the policy is required by the device. Can be either Defined or Unknown

Unknown: The network policy for the specified application type is currently unknown.

Defined: The network policy is defined.

TAG:

TAG is indicative of whether the specified application type is using a tagged or an untagged VLAN. Can be Tagged or Untagged.

Untagged: The device is using an untagged frame format and as such does not include a tag header as defined by IEEE 802.1Q-2003.

Tagged: The device is using the IEEE 802.1Q tagged frame format.

VLAN ID:

VLAN ID is the VLAN identifier (VID) for the port as defined in IEEE 802.1Q-2003. A value of 1 through 4094 is used to define a valid VLAN ID. A value of 0 (Priority Tagged) is used if the device is using priority tagged frames as defined by IEEE 802.1Q-2003, meaning that only the IEEE 802.1D priority level is significant and the default PVID of the ingress port is used instead.

Priority:

Priority is the Layer 2 priority to be used for the specified application type. One of the eight priority levels (0 through 7).

DSCP:

DSCP is the DSCP value to be used to provide Diffserv node behavior for the specified application type as defined in IETF RFC 2474. Contain one of 64 code point values (0 through 63).

Auto-negotiation

Auto-negotiation identifies if MAC/PHY auto-negotiation is supported by the link partner.

Auto-negotiation status

Auto-negotiation status identifies if auto-negotiation is currently enabled at the link partner. If Auto-negotiation is supported and Auto-negotiation status is disabled, the 802.3 PMD operating mode will be determined the operational MAU type field value rather than by auto-negotiation.

Auto-negotiation Capabilities

Auto-negotiation Capabilities shows the link partners MAC/PHY capabilities.

■ Buttons**Auto-refresh:**

Check this box to refresh the page automatically. Automatic refresh occurs every 3 seconds.

Refresh:

Click to refresh the page immediately.

LLDP Neighbor PoE

This page provides a status overview for all LLDP PoE neighbors. The displayed table contains a row for each interface on which an LLDP PoE neighbor is detected. The columns hold the following information:

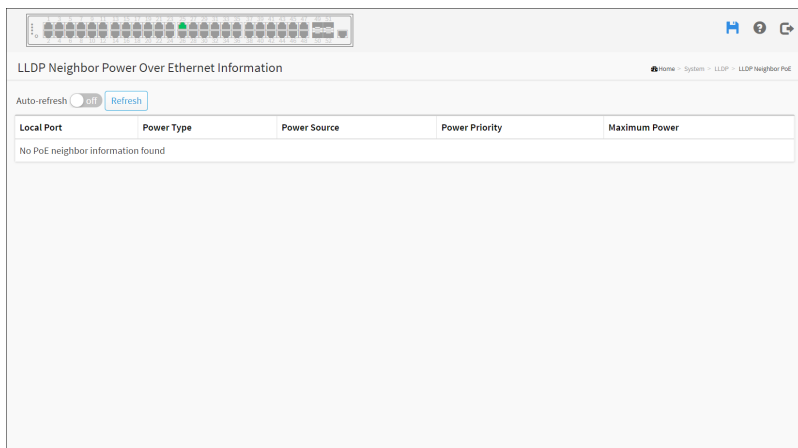

Web Interface

To show LLDP neighbor PoE:

1. Click System, LLDP and LLDP neighbor PoE.
2. Click Refresh for manual update web screen.
3. Click Auto-refresh for auto-update web screen.

■ Parameter description

Local Port:

The interface for this switch on which the LLDP frame was received.

Power Type:

The Power Type represents whether the device is a Power Sourcing Entity (PSE) or Power Device (PD).

If the Power Type is unknown it is represented as “Reserved”.

Power Source:

The Power Source represents the power source being utilized by a PSE or PD device.

If the device is a PSE device it can either run on its Primary Power Source or its Backup Power Source. If it is unknown whether the PSE device is using its Primary Power Source or its Backup Power Source it is indicated as “Unknown”

If the device is a PD device it can either run on its local power supply or it can use the PSE as power source. It can also use both its local power supply and the PSE.

If it is unknown what power supply the PD device is using it is indicated as “Unknown”

Power Priority:

Power Power Priority represents the priority of the PD device, or the power priority associated with the PSE type device's interface that is sourcing the power. There are three levels of power priority. The three levels are: Critical, High and Low.

If the power priority is unknown it is indicated as “Unknown”

Maximum Power:

The Maximum Power Value contains a numerical value that indicates the maximum power in watts required by a PD device from a PSE device, or the minimum power a PSE device is capable of sourcing over a maximum length cable based on its current configuration.

The maximum allowed value is 102.3 W. If the device indicates value higher than 102.3 W, it is represented as “reserved”

■ Buttons

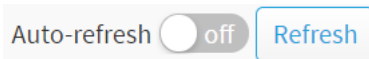

Auto-refresh:

Check this box to refresh the page automatically. Automatic refresh occurs every 3 seconds.

Refresh:

Click to refresh the page immediately.

LLDP Neighbor EEE

By using EEE power savings can be achieved at the expense of traffic latency. This latency occurs due to that the circuits EEE turn off to save power, need

time to boot up before sending traffic over the link. This time is called “wake up time”. To achieve minimal latency, devices can use LLDP to exchange information about their respective tx and rx “wake up time”, as a way to agree upon the minimum wake up time they need.

This page provides an overview of EEE information exchanged by LLDP.

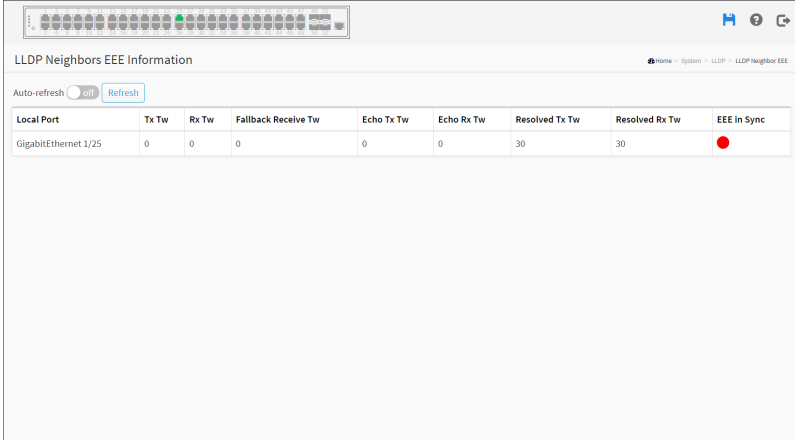

LLDP Neighbors EEE Information

Auto-refresh [Refresh](#)

Local Port	Tx Tw	Rx Tw	Fallback Receive Tw	Echo Tx Tw	Echo Rx Tw	Resolved Tx Tw	Resolved Rx Tw	EEE In Sync
GigabitEthernet 1/25	0	0	0	0	0	30	30	●

Web Interface

To show LLDP neighbor EEE:

1. Click System, LLDP and LLDP neighbor EEE.
2. Click Refresh for manual update web screen.
3. Click Auto-refresh for auto-update web screen.

■ Parameter description

Local Port:

The interface at which LLDP frames are received or transmitted.

Tx Tw:

The link partner's maximum time that transmit path can hold-off sending data after deassertion of LPI.

Rx Tw:

The link partner's time that receiver would like the transmitter to hold-off to allow time for the receiver to wake from sleep.

Fallback Receive Tw:

The link partner's fallback receive Tw.

A receiving link partner may inform the transmitter of an alternate desired Tw_sys_tx. Since a receiving link partner is likely to have discrete levels for savings, this provides the transmitter with additional information that it may use for a more efficient allocation. Systems that do not implement this option default the value to be the same as that of the Receive Tw_sys_tx.

Echo Tx Tw:

The link partner's Echo Tx Tw value.

The respective echo values shall be defined as the local link partners reflection (echo) of the remote link partners respective values. When a local link partner receives its echoed values from the remote link partner it can determine whether or not the remote link partner has received, registered and processed its most recent values. For example, if the local link partner receives echoed parameters that do not match the values in its local MIB, then the local link partner infers that the remote link partners request was based on stale information.

Echo Rx Tw:

The link partner's Echo Rx Tw value.

Resolved Tx Tw:

The resolved Tx Tw for this link. Note : NOT the link partner

The resolved value that is the actual "tx wakeup time " used for this link (based on EEE information exchanged via LLDP).

Resolved Rx Tw:

The resolved Rx Tw for this link. Note : NOT the link partner

The resolved value that is the actual "tx wakeup time " used for this link (based on EEE information exchanged via LLDP).

EEE in Sync:

Shows whether the switch and the link partner have agreed on wake times.

Red - Switch and link partner have not agreed on wakeup times.

Green - Switch and link partner have agreed on wakeup times.

■ Buttons



Auto-refresh:

Check this box to refresh the page automatically. Automatic refresh occurs every 3 seconds.

Refresh:

Click to refresh the page immediately.

LLDP Statistics

Two types of counters are shown. Global counters are counters that refer to the whole switch, while local counters refer to per port counters for the currently selected switch.

LLDP Counters

Auto-refresh Refresh Clear

LLDP Global Counters

Neighbor entries were last changed	2016-01-01T01:39:34+00:00 (1952 secs. ago)
Total Neighbors Entries Added	3
Total Neighbors Entries Deleted	2
Total Neighbors Entries Aged Out	1

LLDP Statistics Local Counters

Local Port	Tx Frames	Rx Frames	Rx Errors	Frames Discarded	TLVs Discarded	TLVs Unrecognized	Orig. Discarded	Age-Outs
1	0	0	0	0	0	0	0	0
2	0	0	0	0	0	0	0	0
3	0	0	0	0	0	0	0	0
4	0	0	0	0	0	0	0	0
5	0	0	0	0	0	0	0	0
6	0	0	0	0	0	0	0	0

Web Interface

To show LLDP Statistics:

1. Click System, LLDP and LLDP Statistics.
2. Click Refresh for manual update web screen.
3. Click Auto-refresh for auto-update web screen.
4. Click Clear to clear all counters.

■ Parameter description:

Global Counters

neighbor entries were last changed at:

It also shows the time when the last entry was last deleted or added. It also shows the time elapsed since the last change was detected.

Total neighbors Entries Added:

Shows the number of new entries added since switch reboot.

Total neighbors Entries Deleted:

Shows the number of new entries deleted since switch reboot.

Total neighbors Entries Dropped:

Shows the number of LLDP frames dropped due to the entry table being full.

Total neighbors Entries Aged Out:

Shows the number of entries deleted due to Time-To-Live expiring.

Local Counters

The displayed table contains a row for each port. The columns hold the following information:

Local Port:

The port on which LLDP frames are received or transmitted.

Tx Frames:

The number of LLDP frames transmitted on the port.

Rx Frames:

The number of LLDP frames received on the port.

Rx Errors:

The number of received LLDP frames containing some kind of error.

Frames Discarded:

If an LLDP frame is received on a port, and the switch's internal table has run full, the LLDP frame is counted and discarded. This situation is known as "Too Many neighbors" in the LLDP standard. LLDP frames require a new entry in the table when the Chassis ID or Remote Port ID is not already contained within the table. Entries are removed from the table when a given port's link is down, an LLDP shutdown frame is received, or when the entry ages out.

TLVs Discarded:

Each LLDP frame can contain multiple pieces of information, known as TLVs (TLV is short for “Type Length Value”). If a TLV is malformed, it is counted and discarded.

TLVs Unrecognized:

The number of well-formed TLVs, but with an unknown type value.

Org. Discarded:

The number of organizationally received TLVs.

Age-Outs:

Each LLDP frame contains information about how long time the LLDP information is valid (age-out time). If no new LLDP frame is received within the age out time, the LLDP information is removed, and the Age-Out counter is incremented.

■ Buttons

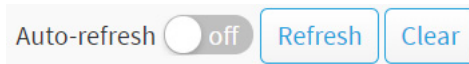

Auto-refresh:

Check this box to refresh the page automatically. Automatic refresh occurs every 3 seconds.

Refresh:

Click to refresh the page immediately.

Clear:

Clears the counters for the selected port.

This Page Intentionally Left Blank

Chapter 4

Port Management

Overview

The section describes to configure the Port detail parameters of the switch. Others you could use the Port configure to enable or disable the Port of the switch. Monitor the ports content or status in the function.

The menu and the submenu are shown below:

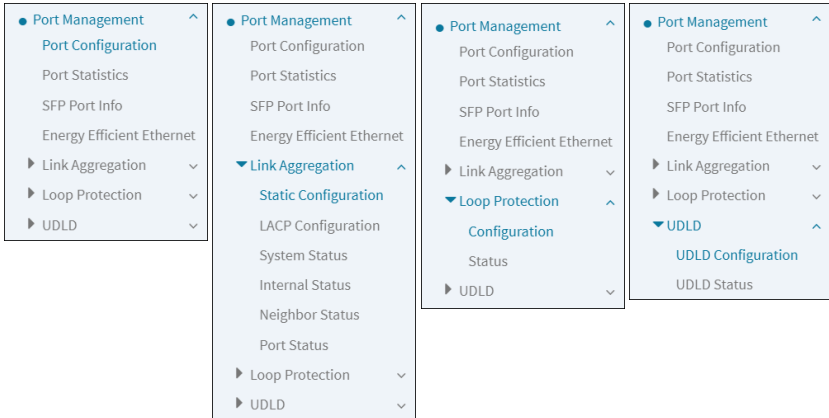

Port Management

The section describes to configure the Port detail parameters of the switch. Others you could use the Port configure to enable or disable the Port of the switch. Monitor the ports content or status in the function.

Port Configuration

This page displays current port configurations. Ports can also be configured here.

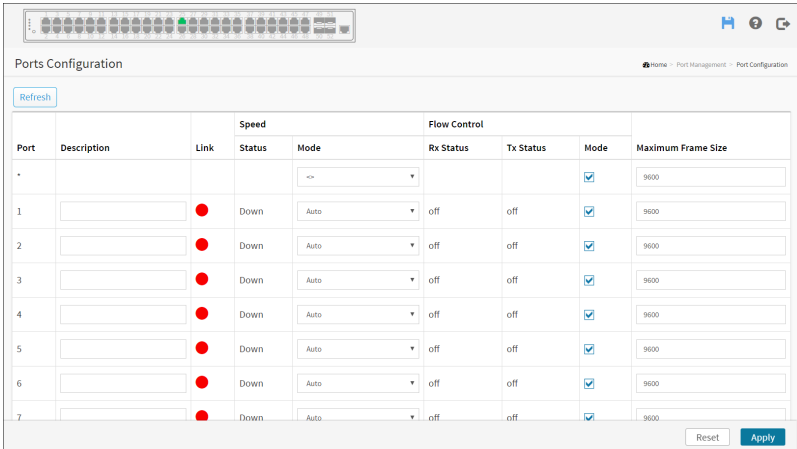

The screenshot shows the 'Ports Configuration' page in a web interface. At the top, there is a 'Refresh' button and a breadcrumb trail: 'Home > Port Management > Port Configuration'. Below the breadcrumb is a table with columns for 'Port', 'Description', 'Link', 'Status', 'Speed', 'Mode', 'Flow Control', 'Rx Status', 'Tx Status', 'Mode', and 'Maximum Frame Size'. The 'Speed' and 'Flow Control' columns are sub-headers for their respective groups of columns. The table lists 7 ports, all with a 'Down' status and a red link indicator. The 'Speed' is set to 'Auto' and 'Flow Control' is set to 'off' for all ports. The 'Maximum Frame Size' is set to '9600' for all ports. At the bottom right of the table, there are 'Reset' and 'Apply' buttons.

Port	Description	Link	Status	Speed		Flow Control				Maximum Frame Size	
					Mode	Rx Status	Tx Status	Mode			
-											
1		●	Down	Auto	▼	off	off	off	off	off	9600
2		●	Down	Auto	▼	off	off	off	off	off	9600
3		●	Down	Auto	▼	off	off	off	off	off	9600
4		●	Down	Auto	▼	off	off	off	off	off	9600
5		●	Down	Auto	▼	off	off	off	off	off	9600
6		●	Down	Auto	▼	off	off	off	off	off	9600
7		●	Down	Auto	▼	off	off	off	off	off	9600

Web Interface

To configure a Current Port Configuration in the web interface:

1. Click Port Management and Port Configuration.
2. Specify the detail Port alias or description an alphanumeric string describing the full name and version identification for the system's hardware type, software version, and networking application.
3. Specify the Speed Configured, Flow Control, Maximum Frame Size.
4. Click Apply.

■ Parameter description:

Port:

This is the logical port number for this row.

Description:

Enter up to 63 characters to be descriptive name for identifies this port.

Link:

The current link state is displayed graphically. Green indicates the link is up and red that it is down.

Current Link Speed Status:

Provides the current link speed of the port.

Configured Link Speed:

Selects any available link speed for the given switch port. Only speeds supported by the specific port is shown. Possible speeds are:

Disabled - Disables the switch port operation.

Auto - Port auto negotiating speed with the link partner and selects the highest speed that is compatible with the link partner.

10Mbps HDX - Forces the cu port in 10Mbps half duplex mode.

10Mbps FDX - Forces the cu port in 10Mbps full duplex mode.

100Mbps HDX - Forces the cu port in 100Mbps half duplex mode.

100Mbps FDX - Forces the cu port in 100Mbps full duplex mode.

1Gbps FDX - Forces the port in 1Gbps full duplex

Flow Control :
When Auto Speed is selected on a port, this section indicates the flow control capability that is advertised to the link partner. When a fixed-speed setting is selected, that is what is used. The Current Rx column indicates whether pause frames on the port are obeyed, and the Current Tx column indicates whether pause frames on the port are transmitted. The Rx and Tx settings are determined by the result of the last Auto-Negotiation.

Check the configured column to use flow control. This setting is related to the setting for Configured Link Speed.

Maximum Frame Size

Enter the maximum frame size allowed for the switch port, including FCS. The range is 1518-10240 bytes.

■ Buttons

Refresh:

You can click them for refresh the Port link Status by manual

Apply:

Click to save changes.

Reset:

Click to undo any changes made locally and revert to previously saved values.

Port Statistics

The section describes to the Port statistics information and provides overview of general traffic statistics for all switch ports.

Port Statistics Overview

Port	Packets		Bytes		Errors		Drops		Filtered
	Received	Transmitted	Received	Transmitted	Received	Transmitted	Received	Transmitted	Received
1	0	0	0	0	0	0	0	0	0
2	0	0	0	0	0	0	0	0	0
3	0	0	0	0	0	0	0	0	0
4	0	0	0	0	0	0	0	0	0
5	0	0	0	0	0	0	0	0	0
6	0	0	0	0	0	0	0	0	0
7	0	0	0	0	0	0	0	0	0
8	0	0	0	0	0	0	0	0	0
9	0	0	0	0	0	0	0	0	0
10	0	0	0	0	0	0	0	0	0
11	0	0	0	0	0	0	0	0	0

Web Interface

To Display the Port Statistics Overview in the web interface:

1. Click Port Management and Port Statistics.
2. If you want to auto-refresh then you need to evoke the “Auto-refresh”.
3. Click “Refresh“ to refresh the port statistics or clear all information when you click “Clear”.
4. If you want to see the detail of port statistic then you need to click that port.

Parameter description:

Port:

The logical port for the settings contained in the same row.

Packets:

The number of received and transmitted packets per port.

Bytes:

The number of received and transmitted bytes per port.

Errors:

The number of frames received in error and the number of incomplete transmissions per port.

Drops:

The number of frames discarded due to ingress or egress congestion.

Filtered

The number of received frames filtered by the forwarding process.

■ Buttons

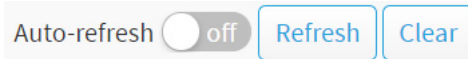

Auto-refresh:

Check this box to refresh the page automatically. Automatic refresh occurs every 3 seconds.

Refresh:

Click to refresh the page.

Clear:

Clears the counters for all ports.

If you want to see the detail of port statistic then you need to click that port. The displayed counters are the totals for receive and transmit, the size counters for receive and transmit, and the error counters for receive and transmit.

Receive Total		Transmit Total	
Rx Packets	10753	Tx Packets	163345
Rx Octets	1673896	Tx Octets	13699853
Rx Unicast	5945	Tx Unicast	6756
Rx Multicast	3430	Tx Multicast	5075
Rx Broadcast	1378	Tx Broadcast	151514
Rx Pause	0	Tx Pause	0
Receive Size Counters		Transmit Size Counters	
Rx 64 Bytes	4397	Tx 64 Bytes	148340
Rx 65-127 Bytes	3452	Tx 65-127 Bytes	11290
Rx 128-255 Bytes	1468	Tx 128-255 Bytes	333
Rx 256-511 Bytes	101	Tx 256-511 Bytes	1408
Rx 512-1023 Bytes	1335	Tx 512-1023 Bytes	83
Rx 1024-1526 Bytes	0	Tx 1024-1526 Bytes	1891
Rx 1527- Bytes	0	Tx 1527- Bytes	0
Receive Queue Counters		Transmit Queue Counters	
Rx Q0	10753	Tx Q0	15072
Rx Q1	0	Tx Q1	0
Rx Q2	0	Tx Q2	0
Rx Q3	0	Tx Q3	0
Rx Q4	0	Tx Q4	0
Rx Q5	0	Tx Q5	0
Rx Q6	0	Tx Q6	0
Rx Q7	0	Tx Q7	148273
Receive Error Counters		Transmit Error Counters	
Rx Drops	0	Tx Drops	0
Rx CRC/Alignment	0	Tx Late/Exc. Coll.	0
Rx Undersize	0		
Rx Oversize	0		
Rx Fragments	0		
Rx Jabber	0		
Rx Filtered	3174		

Parameter description:

Upper left scroll bar:

To scroll which port to display the Port statistics with “Port-1”, “Port-2”, ...

Receive Total and Transmit Total

Rx and Tx Packets:

The number of received and transmitted (good and bad) packets.

Rx and Tx Octets:

The number of received and transmitted (good and bad) bytes. Includes FCS, but excludes framing bits.

Rx and Tx Unicast:

The number of received and transmitted (good and bad) unicast packets.

Rx and Tx Multicast:

The number of received and transmitted (good and bad) multicast packets.

Rx and Tx Broadcast:

The number of received and transmitted (good and bad) broadcast packets.

Rx and Tx Pause:

A count of the MAC Control frames received or transmitted on this port that have an opcode indicating a PAUSE operation.

Receive and Transmit Size Counters

The number of received and transmitted (good and bad) packets split into categories based on their respective frame sizes.

Receive Error Counters**Rx Drops:**

The number of frames dropped due to lack of receive buffers or egress congestion.

Rx CRC/Alignment:

The number of frames received with CRC or alignment errors.

Rx Undersize:

The number of short 1 frames received with valid CRC.

Rx Oversize:

The number of long 2 frames received with valid CRC.

Rx Fragments:

The number of short 1 frames received with invalid CRC.

Rx Jabber:

The number of long 2 frames received with invalid CRC. .

Transmit Error Counters**Tx Drops:**

The number of frames dropped due to output buffer congestion.

Tx Late/Exc. Coll.:

The number of frames dropped due to excessive or late collisions.

Tx Oversize:

The number of frames dropped due to frame oversize.

■ Buttons

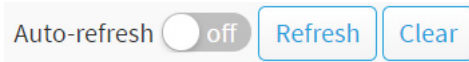

Auto-refresh:

Check this box to refresh the page automatically. Automatic refresh occurs every 3 seconds.

Refresh:

Click to refresh the page.

Clear:

Clears the counters for the selected ports.

SFP Port Info

The section describes that switch could display the SFP module detail information which you connect it to the switch. The information includes: Connector type, Fiber type, wavelength, bit rate and Vendor OUI etc.

SFP Information for Port 49	
Connector Type	none
Fiber Type	none
Tx Central Wavelength	none
Bit Rate	none
Vendor OUI	none
Vendor Name	none
Vendor P/N	none
Vendor Revision	none
Vendor Serial Number	none
Data Code	none
Temperature	none
Vcc	none
Mon1 (Bias)	none
Mon2 (TX PWR)	none
Mon3 (RX PWR)	none

■ Parameter description:

Upper left scroll bar:

To scroll which port to display the Port statistics.

Connector Type:

Display the connector type, for instance, UTP, SC, ST, LC and so on.

Fiber Type:

Display the fiber mode, for instance, Multi-Mode, Single-Mode.

Tx Central Wavelength:

Display the fiber optical transmitting central wavelength, for instance, 850nm, 1310nm, 1550nm and so on.

Bit Rate:

Displays the nominal bit rate of the transceiver.

Vendor OUI:

Display the Manufacturer's OUI code which is assigned by IEEE.

Vendor Name:

Display the company name of the module manufacturer.

Vendor P/N:

Display the product name of the naming by module manufacturer.

Vendor Rev (Revision):

Display the module revision.

Vendor SN (Serial Number):

Show the serial number assigned by the manufacturer.

Date Code:

Show the date this SFP module was made.

Temperature:

Show the current temperature of SFP module.

Vcc:

Show the working DC voltage of SFP module.

Mon1(Bias) mA:

Show the Bias current of SFP module.

Mon2(TX PWR):

Show the transmit power of SFP module.

Mon3(RX PWR):

Show the receiver power of SFP module.

■ Buttons



Auto-refresh:

Check this box to refresh the page automatically. Automatic refresh occurs every 3 seconds.

Refresh:

Click to refresh the page.

Energy Efficient Ethernet

EEE is an abbreviation for Energy Efficient Ethernet defined in IEEE 802.3az.

This page allows the user to inspect and configure the current EEE port settings.

EEE is a power saving option that reduces the power usage when there is very low traffic utilization (or no traffic).

EEE works by powering down circuits when there is no traffic. When a port gets data to be transmitted all circuits are powered up. The time it takes to power up the circuits is named wakeup time. The default wakeup time is 17 us for 1Gbit links and 30 us for other link speeds. EEE devices must agree upon the value of the wakeup time in order to make sure that both the receiving and transmitting device has all circuits powered up when traffic is transmitted. The devices can exchange information about the devices wakeup time using the LLDP protocol.

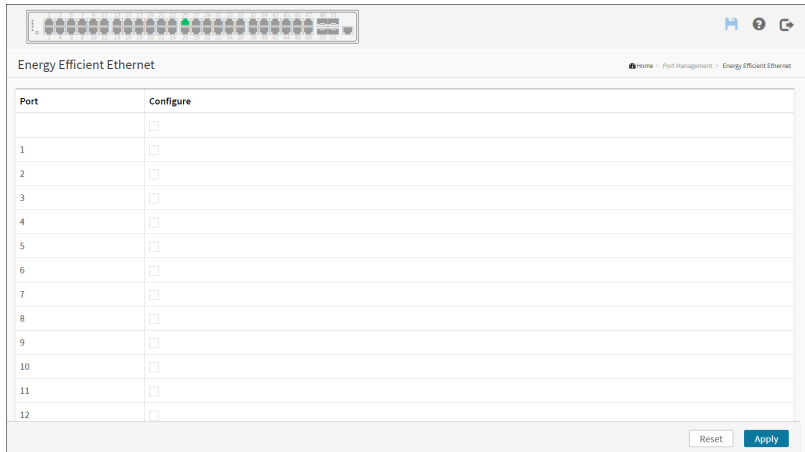

Web Interface

To configure an Energy Efficient Ethernet in the web interface:

1. Click Port Management and Energy Efficient Ethernet.
2. Select enable or disable Energy Efficient Ethernet by the port.
3. Click the apply to save the setting.
4. If you want to cancel the setting then you need to click the Reset button. It will revert to previously saved values.

■ Parameter description:

Port:

The switch port number of the logical EEE port.

Configure:

Controls whether EEE is enabled for this switch port.

Buttons

Apply:

Click to save changes.

Reset:

Click to undo any changes made locally and revert to previously saved values.

Link Aggregation

Static Configuration

This page is used to configure the Aggregation hash mode and the aggregation group.

Aggregation Static Configuration

Home > Port Management > Link Aggregation > Static Configuration

Hash Code Contributors

Source MAC Address	<input checked="" type="checkbox"/>
Destination MAC Address	<input type="checkbox"/>
IP Address	<input checked="" type="checkbox"/>
TCP/UDP Port Number	<input checked="" type="checkbox"/>

Aggregation Group Configuration

Port Members

Group ID	1	2	3	4	5	6	7	8	9	10	11	12	13	14	15	16	17	18	19	20	21	22	23	24	25	26	27	28	29	30	31	32	33	34	35	36
Normal	•	•	•	•	•	•	•	•	•	•	•	•	•	•	•	•	•	•	•	•	•	•	•	•	•	•	•	•	•	•	•	•	•	•	•	•
1	○	○	○	○	○	○	○	○	○	○	○	○	○	○	○	○	○	○	○	○	○	○	○	○	○	○	○	○	○	○	○	○	○	○	○	○
2	○	○	○	○	○	○	○	○	○	○	○	○	○	○	○	○	○	○	○	○	○	○	○	○	○	○	○	○	○	○	○	○	○	○	○	○
3	○	○	○	○	○	○	○	○	○	○	○	○	○	○	○	○	○	○	○	○	○	○	○	○	○	○	○	○	○	○	○	○	○	○	○	○
4	○	○	○	○	○	○	○	○	○	○	○	○	○	○	○	○	○	○	○	○	○	○	○	○	○	○	○	○	○	○	○	○	○	○	○	○

Reset Apply

Web Interface

To configure the Aggregation hash mode and the aggregation group in the web interface:

1. Click Port Management, Link Aggregation and Static Configuration.
2. Evoke to enable or disable the aggregation mode function.
3. Evoke Aggregation Group ID and Port members.
4. Click Apply to save the setting.
5. If you want to cancel the setting then you need to click the reset button. It will revert to previously saved values.

■ Parameter description:

Hash Code Contributors

Source MAC Address:

The Source MAC address can be used to calculate the destination port for the frame. Check to enable the use of the Source MAC address, or uncheck to disable. By default, Source MAC Address is enabled.

Destination MAC Address:

The Destination MAC Address can be used to calculate the destination port for the frame. Check to enable the use of the Destination MAC Address, or uncheck to disable. By default, Destination MAC Address is disabled.

IP Address:

The IP address can be used to calculate the destination port for the frame. Check to enable the use of the IP Address, or uncheck to disable. By default, IP Address is enabled.

TCP/UDP Port Number:

The TCP/UDP port number can be used to calculate the destination port for the frame. Check to enable the use of the TCP/UDP Port Number, or uncheck to disable. By default, TCP/UDP Port Number is enabled.

Aggregation Group Configuration**Group ID:**

Indicates the group ID for the settings contained in the same row. Group ID "Normal" indicates there is no aggregation. Only one group ID is valid per port.

Port Members:

Each switch port is listed for each group ID. Select a radio button to include a port in an aggregation, or clear the radio button to remove the port from the aggregation. By default, no ports belong to any aggregation group. Only full duplex ports can join an aggregation and ports must be in the same speed in each group.

■ Buttons**Apply:**

Click to save changes.

Reset:

Click to undo any changes made locally and revert to previously saved values.

LACP Configuration

This page allows the user to inspect the current LACP port configurations, and possibly change them as well.

Port	LACP Enabled	Key	Role	Timeout	Prio
*	<input type="checkbox"/>	<input type="text"/>	<>	<>	32768
1	<input type="checkbox"/>	<input type="text"/>	Active	Fast	32768
2	<input type="checkbox"/>	<input type="text"/>	Active	Fast	32768
3	<input type="checkbox"/>	<input type="text"/>	Active	Fast	32768
4	<input type="checkbox"/>	<input type="text"/>	Active	Fast	32768
5	<input type="checkbox"/>	<input type="text"/>	Active	Fast	32768
6	<input type="checkbox"/>	<input type="text"/>	Active	Fast	32768
7	<input type="checkbox"/>	<input type="text"/>	Active	Fast	32768
8	<input type="checkbox"/>	<input type="text"/>	Active	Fast	32768
9	<input type="checkbox"/>	<input type="text"/>	Active	Fast	32768
10	<input type="checkbox"/>	<input type="text"/>	Active	Fast	32768

Reset Apply

Web Interface

To configure the LACP Port Configuration in the web interface:

1. Click Port Management, Link Aggregation and LACP Configuration.
2. Evoke to enable or disable the LACP on the port of the switch.
3. Scroll the Key parameter with Auto or Specific. Default is Auto.
4. Scroll the Role with Active or Passive. Default is Active.
5. Click Apply to save the setting.
6. If you want to cancel the setting then you need to click the reset button. It will revert to previously saved values.

■ Parameter description:

Port:

The switch port number.

LACP Enabled:

Controls whether LACP is enabled on this switch port. LACP will form an aggregation when 2 or more ports are connected to the same partner.

Key:

Using the Specific setting, a user-defined value from 1 to 26 can be entered. Ports with the same Key value can participate in the same aggregation group, while ports with different keys cannot.

Role:

The Role shows the LACP activity status. The Active will transmit LACP packets each second, while Passive will wait for a LACP packet from a partner (speak if spoken to).

Timeout:

The Timeout controls the period between BPDU transmissions. Fast will transmit LACP packets each second, while Slow will wait for 30 seconds before sending a LACP packet.

Prio:

The Prio controls the priority of the port. If the LACP partner wants to form a larger group than is supported by this device then this parameter will control which ports will be active and which ports will be in a backup role. Lower number means greater priority.

■ **Buttons**

Apply:

Click to save changes.

Reset:

Click to undo any changes made locally and revert to previously saved values.

System Status

This section describes that when you complete to set LACP function on the switch then it provides a status overview for all LACP instances

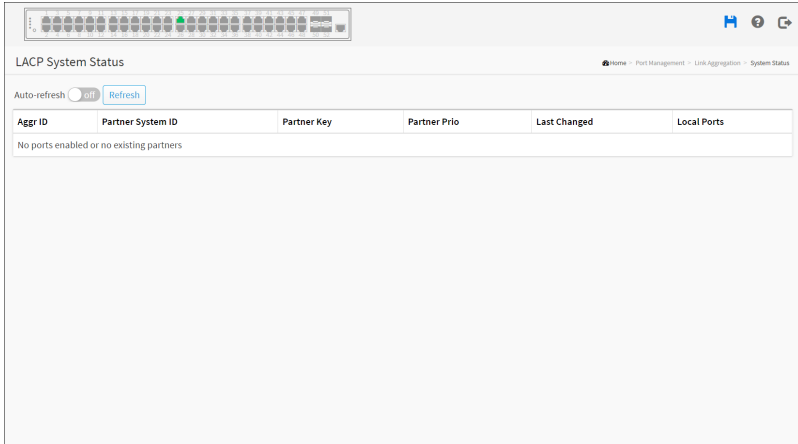

Web Interface

To display the LACP System status in the web interface:

1. Click Port Management, Link Aggregation and System Status.
2. Checked “Auto-refresh”.
3. Click “Refresh” to refresh the port detailed statistics.

■ Parameter description:

Aggr ID:

The Aggregation ID associated with this aggregation instance. For LLAG the id is shown as 'isid: aggr-id' and for GLAGs as 'aggr-id'

Partner System ID:

The system ID (MAC address) of the aggregation partner.

Partner Key:

The Key that the partner has assigned to this aggregation ID.

Partner Prio

The priority that the partner has assigned to this aggregation ID.

Last changed:

The time since this aggregation changed.

Local Ports:

Shows which ports are a part of this aggregation for this switch. The format is: "Switch ID:Port".

■ Buttons



Auto-refresh:

Check this box to refresh the page automatically. Automatic refresh occurs every 3 seconds.

Refresh:

Click to refresh the page.

Internal Status

This page provides a status overview for the LACP internal (i.e. local system) status for all ports. Only ports that are part of an LACP group are shown. For details on the shown parameters please refer to IEEE 801.AX-2014.

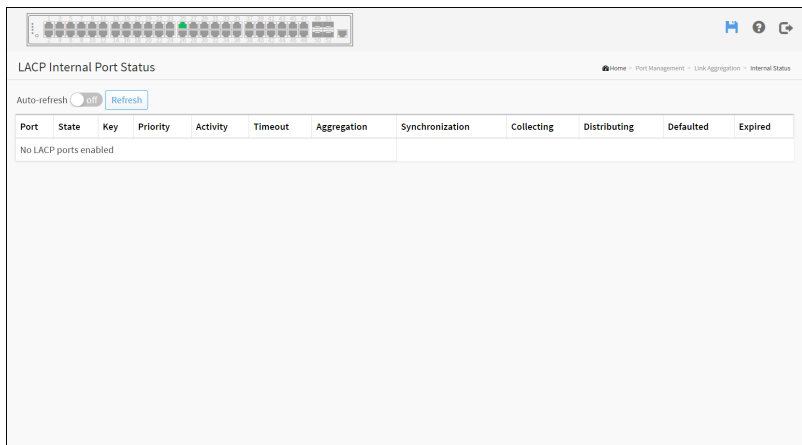

Web Interface

To display the LACP Internal System status in the web interface:

1. Click Port Management, Link Aggregation and Internal Status.
2. Checked "Auto-refresh".
3. Click "Refresh" to refresh the port detailed statistics.

■ Parameter description:

Port:

The switch port number.

State:

The current port state:

Down: The port is not active.

Active: The port is in active state.

Standby: The port is in standby state.

Key:

The key assigned to this port. Only ports with the same key can aggregate together.

Priority:

The priority assigned to this aggregation group.

Activity:

The LACP mode of the group (Active or Passive).

Timeout:

The timeout mode configured for the port (Fast or Slow).

Aggregation:

Show whether the system considers this link to be “aggregateable”; i.e., a potential candidate for aggregation.

Synchronization:

Show whether the system considers this link to be “IN_SYNC”; i.e., it has been allocated to the correct LAG, the group has been associated with a compatiXBFe Aggregator, and the identity of the LAG is consistent with the System ID and operational Key information transmitted.

Collecting:

Show if collection of incoming frames on this link is enabled.

Distributing:

Show if distribution of outgoing frames on this link is enabled.

Defaulted:

Show if the Actor's Receive machine is using Defaulted operational Partner information.

Expired:

Show if that the Actor's Receive machine is in the EXPIRED state.

■ Buttons



Auto-refresh:

Check this box to refresh the page automatically. Automatic refresh occurs every 3 seconds.

Refresh:

Click to refresh the page.

Neighbor Status

This page provides a status overview for the LACPneighbor status for all ports. Only ports that are part of an LACP group are shown. For details on the shown parameters please refer to IEEE 801.AX-2014.

Port	State	Aggr ID	Partner Key	Partner Port	Partner Port Prio	Activity	Timeout	Aggregation	Synchronization	Collecting	Distributing	Defaulted	Expired
No LACP neighbor status available													

Web Interface

To display the LACP Neighbor Port status in the web interface:

1. Click Port Management, Link Aggregation and Neighbor Status.
2. Checked “Auto-refresh”.

3. Click “Refresh” to refresh the port detailed statistics.

Parameter description:

Aggr ID:

The aggregation group ID which the port is assigned to.

Port:

The switch port number.

State:

The current port state:

Down: The port is not active.

Active: The port is in active state.

Standby: The port is in standby state.

Partner Key

The key assigned to this port by the partner.

Partner Port

The partner port number associated with this link.

Partner Port Priority

The priority assigned to this partner port .

Activity:

The LACP mode of the group (Active or Passive).

Timeout:

The timeout mode configured for the port (Fast or Slow).

Aggregation:

Show whether the system considers this link to be “aggregateable”; i.e., a potential candidate for aggregation.

Synchronization:

Show whether the system considers this link to be “IN_SYNC”; i.e., it has been allocated to the correct LAG, the group has been associated with a compatiXBF e Aggregator, and the identity of the LAG is consistent with the System ID and operational Key information transmitted.

Collecting:

Show if collection of incoming frames on this link is enabled.

Distributing:

Show if distribution of outgoing frames on this link is enabled.

Defaulted:

Show if the Actor's Receive machine is using Defaulted operational Partner information.

Expired:

Show if that the Actor's Receive machine is in the EXPIRED state.

■ **Buttons**

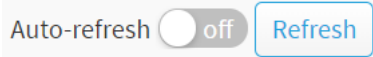

Auto-refresh:

Check this box to refresh the page automatically. Automatic refresh occurs every 3 seconds.

Refresh:

Click to refresh the page.

Port Status

This section describes that when you complete to set LACP function on the switch then it provides a Port Status overview for all LACP instances

Port	LACP	Key	Aggr ID	Partner System ID	Partner Port	Partner Prio
1	No	-	-	-	-	-
2	No	-	-	-	-	-
3	No	-	-	-	-	-
4	No	-	-	-	-	-
5	No	-	-	-	-	-
6	No	-	-	-	-	-
7	No	-	-	-	-	-
8	No	-	-	-	-	-
9	No	-	-	-	-	-
10	No	-	-	-	-	-
11	No	-	-	-	-	-
12	No	-	-	-	-	-
13	No	-	-	-	-	-
14	No	-	-	-	-	-

Web Interface

To display the LACP Port status in the web interface:

1. Click Port Management, Link Aggregation and Port Status.
2. If you want to auto-refresh the information then you need to evoke the “Auto-refresh”.
3. Click “Refresh” to refresh the LACP Port Status.

■ Parameter description:

Port:

The switch port number.

LACP:

'Yes' means that LACP is enabled and the port link is up. 'No' means that LACP is not enabled or that the port link is down. 'Backup' means that the port could not join the aggregation group but will join if other port leaves. Meanwhile it's LACP status is disabled.

Key:

The key assigned to this port. Only ports with the same key can aggregate together.

Aggr ID:

The Aggregation ID assigned to this aggregation group. IDs 1 and 2 are GLAGs while IDs 3-14 are LLAGs.

Partner System ID:

The partner's System ID (MAC address).

Partner Port:

The partner's port number connected to this port.

Partner Prio:

The partner's port priority.

■ Buttons



Auto-refresh:

Check this box to refresh the page automatically. Automatic refresh occurs every 3 seconds.

Refresh:

Click to refresh the page.

Loop Protection

Configuration

The loop Protection is used to detect the presence of traffic. When switch receives packet's (looping detection frame) MAC address the same as oneself from port, show Loop Protection happens. The port will be locked when it received the looping Protection frames. If you want to resume the locked port, please find out the looping path and take off the looping path, then select the resume the locked port and click on "Resume" to turn on the locked ports.

Port	Enable	Action	Tx Mode
*	<input checked="" type="checkbox"/>	<>	<>
1	<input checked="" type="checkbox"/>	Shutdown Port	Enable
2	<input checked="" type="checkbox"/>	Shutdown Port	Enable
3	<input checked="" type="checkbox"/>	Shutdown Port	Enable
4	<input checked="" type="checkbox"/>	Shutdown Port	Enable

Web Interface

To configure the Loop Protection parameters in the web interface:

1. Click Port Management, Loop Protection and Configuration.
2. Evoke to select enable or disable the port loop Protection.
3. Click the apply to save the setting.
4. If you want to cancel the setting then you need to click the Reset button. It will revert to previously saved values.

■ Parameter description:

Global Configuration

Enable Loop Protection:

Controls whether loop protections is enabled (as a whole).

Transmission Time:

The interval between each loop protection PDU sent on each port. Valid values are 1 to 10 seconds.

Shutdown Time:

The period (in seconds) for which a port will be kept disabled in the event of a loop is detected (and the port action shuts down the port). Valid values are 10 to 604800 seconds (7 days).

Port Configuration**Port:**

The switch port number of the port.

Enable:

Controls whether loop protection is enabled on this switch port

Action:

Configures the action performed when a loop is detected on a port. Valid values are Shutdown Port, Shutdown Port and Log or Log Only.

Tx Mode:

Controls whether the port is actively generating loop protection PDU's, or whether it is just passively looking for looped PDU's.

■ Buttons**Apply:**

Click to save changes.

Reset:

Click to undo any changes made locally and revert to previously saved values.

Status

This section displays the loop protection port status the ports of the currently selected switch.

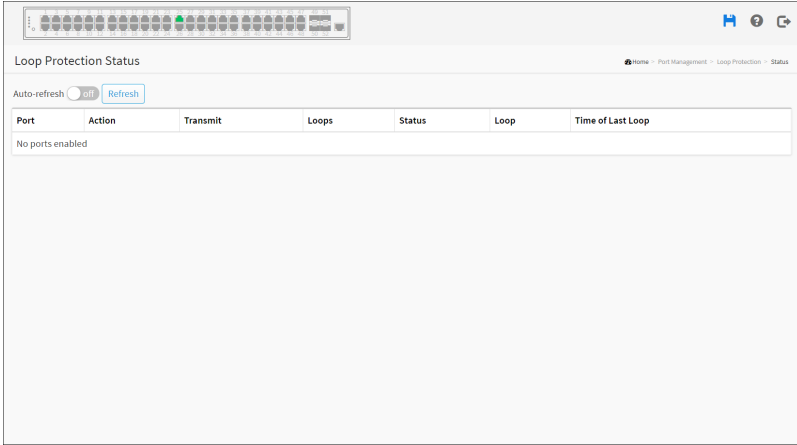

Web Interface

To display the Loop Protection status in the web interface:

1. Click Port Management, Loop Protection and Status.
2. If you want to auto-refresh the information then you need to evoke the “Auto refresh”.
3. Click “Refresh” to refresh the Loop Protection Status.

■ Parameter description:

Port:

The switch port number of the logical port.

Action:

The currently configured port action.

Transmit:

The currently configured port transmit mode.

Loops:

The number of loops detected on this port.

Status:

The current loop protection status of the port.

Loop:

Whether a loop is currently detected on the port.

Time of Last Loop:

The time of the last loop event detected.

■ **Buttons**



Auto-refresh:

Check this box to refresh the page automatically. Automatic refresh occurs every 3 seconds.

Refresh:

Click to refresh the page.

UDLD

UDLD Configuration

This page allows the user to inspect the current UDLD configurations, and possibly change them as well.

Port	UDLD mode	Message Interval
*	<>	?
1	Disable	7
2	Disable	7
3	Disable	7
4	Disable	7
5	Disable	7
6	Disable	7
7	Disable	7
8	Disable	7
9	Disable	7
10	Disable	7

Reset Apply

Web Interface

To configure the UDLD parameters in the web interface:

1. Click Port Management, UDLD and UDLD Configuration.
2. Evoke to select enable or disable the port UDLD.
3. Specify the Message Interval.
4. Click the apply to save the setting.
5. If you want to cancel the setting then you need to click the Reset button. It will revert to previously saved values.

■ Parameter description:

Port:

Port number of the switch.

UDLD Mode:

Configures the UDLD mode on a port. Valid values are Disable, Normal and Aggressive. Default mode is Disable.

Disable: In disabled mode, UDLD functionality doesn't exist on port.

Normal: In normal mode, if the link state of the port was determined to be unidirectional, it will not affect the port state.

Aggressive: In aggressive mode, unidirectional detected ports will get shutdown. To bring back the ports up, need to disable UDLD on that port.

Message Interval:

Configures the period of time between UDLD probe messages on ports that are in the advertisement phase and are determined to be bidirectional. The range is from 7 to 90 seconds (Default value is 7 seconds) (Currently default time interval is supported, due to lack of detailed information in RFC 5171).

■ Buttons

Apply:

Click to save changes.

Reset:

Click to undo any changes made locally and revert to previously saved values.

UDLD Status

This page displays the UDLD status of the ports

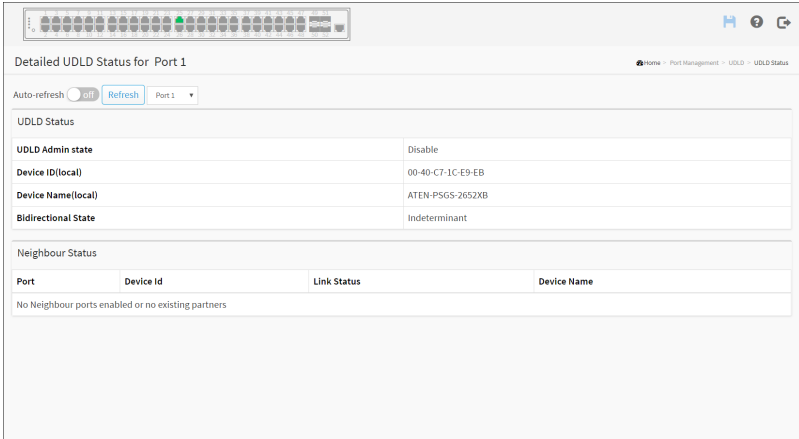

Detailed UDLD Status for Port 1

Auto-refresh Refresh Port 1

UDLD Status	
UDLD Admin state	Disable
Device ID(local)	00-40-C7-1C-E9-EB
Device Name(local)	ATEN-PSGS-2652XB
Bidirectional State	Indeterminant

Neighbour Status			
Port	Device Id	Link Status	Device Name
No Neighbour ports enabled or no existing partners			

Web Interface

To display the Loop Protection status in the web interface:

1. Click Port Management, UDLD and UDLD Status.

2. Select port that you want to display the UDLD Status.
3. If you want to auto-refresh the information then you need to evoke the “Auto refresh”.
4. Click “Refresh” to refresh the Loop Protection Status.

■ **Parameter description:**

UDLD port status

UDLD Admin State:

The current port state of the logical port, Enabled if any of state(Normal,Aggressive) is Enabled.

Device ID(local): The ID of Device.

Device Name(local): Name of the Device.

Bidirectional State: The current state of the port.

Neighbor Status

Port:

The current port of neighbor device.

Device ID:

The current ID of neighbor device.

Link Status:

The current link status of neighbor port.

Device Name:

Name of the neighbor Device.

■ **Buttons**



Auto-refresh:

Check this box to refresh the page automatically. Automatic refresh occurs every 3 seconds.

Refresh:

Click to refresh the page immediately.

Port 1:

Select port that you want to display the DHCP Detailed Statistics.

This Page Intentionally Left Blank

Chapter 5

PoE Management (ES0152P Only)

Overview

PoE is an acronym for Power over Ethernet. Power over Ethernet is used to transmit electrical power, to remote devices over standard Ethernet cable. It could for example be used for powering IP telephones, wireless LAN access points and other equipment, where it would be difficult or expensive to connect the equipment to main power supply.

The menu is shown below:

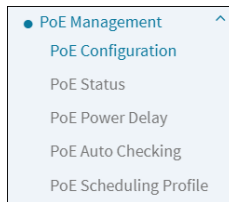

PoE Configuration

This page allows the user to inspect and configure the current PoE port settings and show all PoE Supply W.

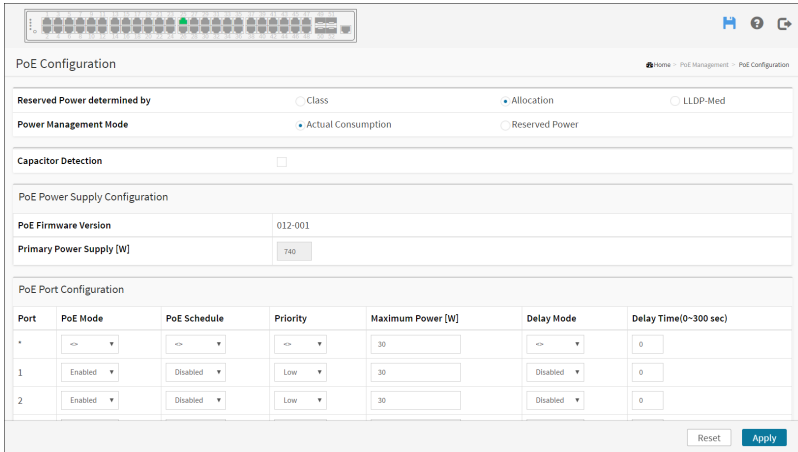

PoE Configuration

Reserved Power determined by Class Allocation LLDP-Med

Power Management Mode Actual Consumption Reserved Power

Capacitor Detection

PoE Power Supply Configuration

PoE Firmware Version 012-001

Primary Power Supply [W] 740

PoE Port Configuration

Port	PoE Mode	PoE Schedule	Priority	Maximum Power [W]	Delay Mode	Delay Time(0-300 sec)
*	←	←	←	30	←	0
1	Enabled	Disabled	Low	30	Disabled	0
2	Enabled	Disabled	Low	30	Disabled	0

Reset Apply

Web Interface

To configure Power over Ethernet in the web interface:

1. Click PoE Management and PoE Configuration.
2. Specify the Reserved Power determined.
3. Specify the PoE or PoE+ Mode, PoE Schedule, Priority, Maximum Power(W), Delay Mode and Delay Time.
4. Click Apply to save the configuration.
5. If you want to cancel the setting then you need to click the Reset button. It will revert to previously saved values.

■ Parameter description:

Power Over Ethernet Configuration

Reserved Power determined by:

There are three modes for configuring how the ports/PDs may reserve power.

1. Allocated mode: In this mode the user allocates the amount of power that each port may reserve. The allocated/reserved power for each port/PD is specified in the Maximum Power fields.

2. Class mode: In this mode each port automatically determines how much power to reserve according to the class the connected PD belongs to, and reserves the power accordingly. Four different port classes exist and one for 4, 7, 15.4 or 30 Watts.

In this mode the Maximum Power fields have no effect.

3. LLDP-MED mode: This mode is similar to the Class mode expect that each port determine the amount power it reserves by exchanging PoE information using the LLDP protocol and reserves power accordingly. If no LLDP information is available for a port, the port will reserve power using the class mode

In this mode the Maximum Power fields have no effect

For all modes: If a port uses more power than the reserved power for the port, the port is shut down.

Power Management Mode:

There are 2 modes for configuring when to shut down the ports:

1. Actual Consumption: In this mode the ports are shut down when the actual power consumption for all ports exceeds the amount of power that the power supply can deliver or if the actual power consumption for a given port exceeds the reserved power for that port. The ports are shut down according to the ports priority. If two ports have the same priority the port with the highest port number is shut down.

2. Reserved Power: In this mode the ports are shut down when total reserved powered exceeds the amount of power that the power supply can deliver. In this mode the port power is not turned on if the PD requests more power than available from the power supply.

Capacitor Detection (legacy mode):

Check to enable compatibility support for legacy PD products manufactured before the ratification of the IEEE 802.3af standard.

PoE Power Supply Configuration

Primary Power Supply [W]:

To display watts for the primary power supply.

PoE Port Configuration

Port:

This is the logical port number for this row.

PoE Mode:

The PoE Mode represents the PoE operating mode for the port. Enable or Disable PoE.

PoE Schedule:

Disable or Select the PoE Schedule profile.

Priority:

The Priority represents the ports priority. There are three levels of power priority named Low, High and Critical.

The priority is used in the case where the remote devices requires more power than the power supply can deliver. In this case the port with the lowest priority will be turn off starting from the port with the highest port number.

Maximum Power [W]:

The Maximum Power value contains a numerical value that indicates the maximum power in watts that can be delivered to a remote device.

The maximum allowed value is 30 W.

Delay Mode:

Turn on / off the power delay function.

Enabled: Enable POE Power Delay.

Disabled: Disable POE Power Delay.

Delay Time(0~300sec):

When rebooting, the PoE port will start to provide power to the PD when it out of delay time. default: 0, range: 0-300 sec.

■ **Buttons**

Apply:

Click to save changes.

Reset:

Click to undo any changes made locally and revert to previously saved values.

PoE Status

This page allows the user to inspect the current status for all PoE ports.

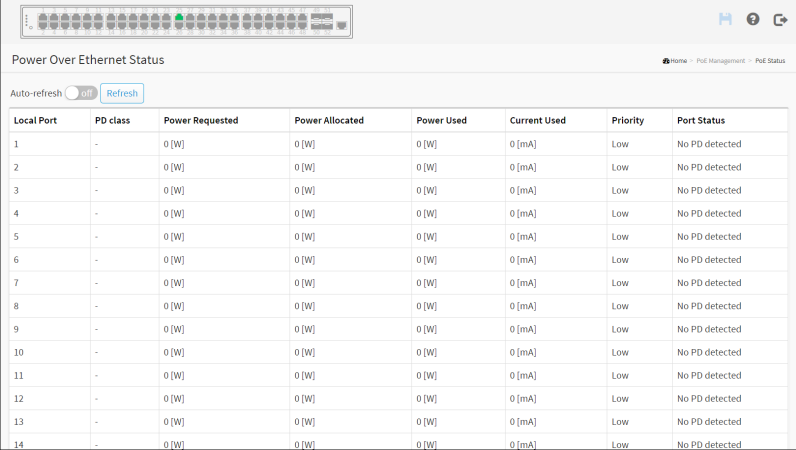

The screenshot shows the 'Power Over Ethernet Status' page. At the top, there is a navigation bar with 'Home', 'PoE Management', and 'PoE Status'. Below the navigation bar, there is a control panel with 'Auto-refresh' set to 'off' and a 'Refresh' button. The main content is a table with 14 rows, each representing a port. The table columns are: Local Port, PD class, Power Requested, Power Allocated, Power Used, Current Used, Priority, and Port Status. All ports show 0 [W] for power and 0 [mA] for current, with a priority of 'Low' and 'No PD detected' status.

Local Port	PD class	Power Requested	Power Allocated	Power Used	Current Used	Priority	Port Status
1	-	0 [W]	0 [W]	0 [W]	0 [mA]	Low	No PD detected
2	-	0 [W]	0 [W]	0 [W]	0 [mA]	Low	No PD detected
3	-	0 [W]	0 [W]	0 [W]	0 [mA]	Low	No PD detected
4	-	0 [W]	0 [W]	0 [W]	0 [mA]	Low	No PD detected
5	-	0 [W]	0 [W]	0 [W]	0 [mA]	Low	No PD detected
6	-	0 [W]	0 [W]	0 [W]	0 [mA]	Low	No PD detected
7	-	0 [W]	0 [W]	0 [W]	0 [mA]	Low	No PD detected
8	-	0 [W]	0 [W]	0 [W]	0 [mA]	Low	No PD detected
9	-	0 [W]	0 [W]	0 [W]	0 [mA]	Low	No PD detected
10	-	0 [W]	0 [W]	0 [W]	0 [mA]	Low	No PD detected
11	-	0 [W]	0 [W]	0 [W]	0 [mA]	Low	No PD detected
12	-	0 [W]	0 [W]	0 [W]	0 [mA]	Low	No PD detected
13	-	0 [W]	0 [W]	0 [W]	0 [mA]	Low	No PD detected
14	-	0 [W]	0 [W]	0 [W]	0 [mA]	Low	No PD detected

Web Interface

To Display PoE Status in the web interface:

1. Click PoE Management and PoE Status.
2. Scroll “Auto-refresh” to on/off.
3. Click “Refresh” to refresh the port detailed statistics.

■ Parameter description:

Local Port:

This is the logical port number for this row.

PD Class:

Each PD is classified according to a class that defines the maximum power the PD will use. The PD Class shows the PDs class.

Five Classes are defined:

Class 0: Max. power 15.4 W

Class 1: Max. power 4.0 W

Class 2: Max. power 7.0 W

Class 3: Max. power 15.4 W

Class 4: Max. power 30.0 W

Power Requested

The Power Requested shows the requested amount of power the PD wants to be reserved.

Power Allocated:

The Power Allocated shows the amount of power the switch has allocated for the PD.

Power Used:

The Power Used shows how much power the PD currently is using.

Current Used:

The Power Used shows how much current the PD currently is using.

Priority:

The Priority shows the port's priority configured by the user.

Port Status:

The Port Status shows the port's status. The status can be one of the following values:

PoE not available - No PoE chip found - PoE not supported for the port.

PoE turned OFF - PoE disabled : PoE is disabled by user.

PoE turned OFF - Power budget exceeded - The total requested or used power by the PDs exceeds the maximum power the Power Supply can deliver, and port(s) with the lowest priority is/are powered down.

No PD detected - No PD detected for the port.

PoE turned OFF - PD overload - The PD has requested or used more power than the port can deliver, and is powered down.

PoE turned OFF - PD is off.

Invalid PD - PD detected, but is not working correctly.

■ Buttons



Auto-refresh:

Check this box to refresh the page automatically. Automatic refresh occurs every 3 seconds.

Refresh:

Click to refresh the page.

PoE Power Delay

This page allows the user to setting the delay time of power providing after device rebooted.

Port	Delay Mode	Delay Time(0-300 sec)
*	<-	0
1	Disabled	0
2	Disabled	0
3	Disabled	0
4	Disabled	0
5	Disabled	0
6	Disabled	0
7	Disabled	0
8	Disabled	0
9	Disabled	0
10	Disabled	0

Web Interface

To Display Power over Ethernet Status in the web interface:

1. Click PoE Management and PoE Power delay.
2. Enable the port to the power device.
3. Specify the power providing delay time when reboot.
4. Click Apply to apply the change.

■ Parameter description:

Port:

This is the logical port number for this row.

Delay Mode:

Turn on / off the power delay function.

Enabled: Enable POE Power Delay.

Disabled: Disable POE Power Delay.

Delay Time (0~300sec):

When rebooting, the PoE port will start to provide power to the PD when it out of delay time. Default: 0, range: 0-300 sec.

■ **Buttons**

Apply:

Click to save changes.

Reset:

Click to undo any changes made locally and revert to previously saved values.

PoE Auto Checking

This page allows the user to specify the auto detection parameters to check the linking status between PoE ports and PDs. When it detected the fail connect, will reboot remote PD automatically.

Port	Ping IP Address	StartUp Time	Interval Time(sec)	Retry Time	Failure Log	Failure Action	Reboot Time(sec)
1	0.0.0.0	60	30	3	error=0,total=0	Nothing	15
2	0.0.0.0	60	30	3	error=0,total=0	Nothing	15
3	0.0.0.0	60	30	3	error=0,total=0	Nothing	15
4	0.0.0.0	60	30	3	error=0,total=0	Nothing	15
5	0.0.0.0	60	30	3	error=0,total=0	Nothing	15
6	0.0.0.0	60	30	3	error=0,total=0	Nothing	15
7	0.0.0.0	60	30	3	error=0,total=0	Nothing	15
8	0.0.0.0	60	30	3	error=0,total=0	Nothing	15
9	0.0.0.0	60	30	3	error=0,total=0	Nothing	15

Web Interface

To configure Power over Ethernet Auto Checking in the web interface:

1. Click PoE Management and PoE Auto checking.
2. Enable the Ping Check function.
3. Specify the PD's IP address, checking startup time, interval time, retry time, failure action and reboot time.
4. Click Apply to apply the change.

■ Parameter description:

Ping Check:

Enable Ping Check function can detects the connection between PoE port and power device. Disable will turn off the detection.

Port:

This is the logical port number for this row.

Ping IP Address:

The PD's IP Address the system should ping.

Startup Time:

After startup time, device will enable auto checking. Default: 30, range: 30-60 sec.

Interval Time(sec):

Device will send checking message to PD each interval time. Default: 30, range: 10-120 sec.

Retry Time:

When PoE port can't ping the PD, it will retry to send detection again. When the third time, it will trigger failure action. Default: 3, range: 1-5.

Failure Log:

Failure loggings counter.

Failure Action:

The action when the third fail detection.

Nothing: Keep Ping the remote PD but does nothing further.

Reboot: Cut off the power of the PoE port, make PD rebooted.

Reboot time (sec):

When PD has been rebooted, the PoE port restored power after the specified time. Default: 15, range: 3-120 sec.

■ Buttons**Apply:**

Click to save changes.

Reset:

Click to undo any changes made locally and revert to previously saved values.

PoE Scheduling Profile

This page allows user to define the profile for PoE scheduling.

PoE Schedule Profile

Home - PoE Management - PoE Scheduling Profile

Profile: 1

Name: Profile 1

Week Day	Start Time		End Time	
	HH	MM	HH	MM
*	<<	<<	<<	<<
Monday	0	0	0	0
Tuesday	0	0	0	0
Wednesday	0	0	0	0
Thursday	0	0	0	0
Friday	0	0	0	0
Saturday	0	0	0	0
Sunday	0	0	0	0

Reset Apply

Web Interface

To configure PoE Schedule Profile in the web interface:

1. Click PoE Management and PoE Scheduling Profile.
2. Select profile number and specify the profile name.
3. Select Week Day and Specify Start Time, End Time.
4. Click Apply to apply the change.

■ Parameter description:

Profile:

The index of profile. There are 16 profiles in the configuration.

Name:

The name of profile. The default name is "Profile #". User can define the name for identifying the profile.

Week Day:

The day to schedule PoE.

Start Time:

The time to start PoE. The time 00:00 means the first second of this day.

End Time:

The time to stop PoE. The time 00:00 means the last second of this day.

■ **Buttons**

Apply:

Click to save changes.

Reset:

Click to undo any changes made locally and revert to previously saved values.

This Page Intentionally Left Blank

Chapter 6

VLAN Management

Overview

To assign a specific VLAN for management purpose. The management VLAN is used to establish an IP connection to the switch from a workstation connected to a port in the VLAN. This connection supports a VSM, SNMP, and Telnet session. By default, the active management VLAN is VLAN 1, but you can designate any VLAN as the management VLAN using the Management VLAN window. Only one management VLAN can be active at a time.

When you specify a new management VLAN, your HTTP connection to the old management VLAN is lost. For this reason, you should have a connection between your management station and a port in the new management VLAN or connect to the new management VLAN through a multi-VLAN route.

The menu and the submenu are shown below:

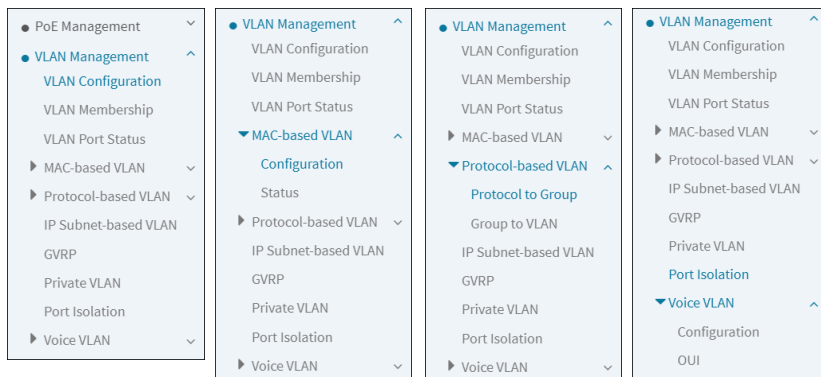

VLAN Configuration

VLAN Configuration

Home > VLAN Management > VLAN Configuration

Global VLAN Configuration

Allowed Access VLANs: 1 (e.g. 1,2,10-13,15)

Ethertype for Custom S-ports: 88A6

Port VLAN Configuration

Port	Mode	Port VLAN	Port Type	Ingress Filtering	Ingress Acceptance	Egress Tagging	Allowed VLANs	Forbidden VLANs
1	Access	1	C-Port	<input checked="" type="checkbox"/>	Tagged and Untagged	Untag Port VLAN	1	
2	Access	1	C-Port	<input checked="" type="checkbox"/>	Tagged and Untagged	Untag Port VLAN	1	
3	Access	1	C-Port	<input checked="" type="checkbox"/>	Tagged and Untagged	Untag Port VLAN	1	
4	Access	1	C-Port	<input checked="" type="checkbox"/>	Tagged and Untagged	Untag Port VLAN	1	
5	Access	1	C-Port	<input checked="" type="checkbox"/>	Tagged and Untagged	Untag Port VLAN	1	
6	Access	1	C-Port	<input checked="" type="checkbox"/>	Tagged and Untagged	Untag Port VLAN	1	

Reset Apply

Web Interface

To configure VLAN membership configuration in the web interface:

1. Click VLAN Management and VLAN Configuration.
2. Modify Global VLAN Configuration parameter.
3. Scroll the Mode, Port VLAN and Port Type to enable the Port VLAN Configuration parameter.
4. Click the Apply to save the setting.
5. If you want to cancel the setting then you need to click the Reset button. It will revert to previously saved values.

■ Parameter description:

Global VLAN Configuration

Allowed Access VLANs:

This field shows the VLANs that are created on the switch.

By default, only VLAN 1 exists. More VLANs may be created by using a list syntax where the individual elements are separated by commas. Ranges are specified with a dash separating the lower and upper bound.

The following example will create VLANs 1, 10, 11, 12, 13, 200, and 300: 1,10-13,200,300. Spaces are allowed in between the delimiters.

Ethertype for Custom S-ports:

This field specifies the ethertype/TPID (specified in hexadecimal) used for Custom S-ports. The setting is in force for all ports whose Port Type is set to S-Custom-Port.

Port VLAN Configuration

Port:

This is the logical port number of this row.

Mode:

The port mode (default is Access) determines the fundamental behavior of the port in question. A port can be in one of three modes as described below. Whenever a particular mode is selected, the remaining fields in that row will be either grayed out or made changeable depending on the mode in question. Grayed out fields show the value that the port will get when the mode is applied.

Access:

Access ports are normally used to connect to end stations. Dynamic features like Voice VLAN may add the port to more VLANs behind the scenes. Access ports have the following characteristics:

- Member of exactly one VLAN, the Port VLAN (a.k.a. Access VLAN), which by default is 1,
- accepts untagged frames and C-tagged frames,
- discards all frames that are not classified to the Access VLAN,
- on egress all frames are transmitted untagged.

Trunk:

Trunk ports can carry traffic on multiple VLANs simultaneously, and are normally used to connect to other switches. Trunk ports have the following characteristics:

- By default, a trunk port is member of all existing VLANs. This may be limited by the use of Allowed VLANs,
- unless VLAN Trunking is enabled on the port, frames classified to a VLAN that the port is not a member of will be discarded,
- by default, all frames but frames classified to the Port VLAN (a.k.a. Native VLAN) get tagged on egress. Frames classified to the Port VLAN do not get C-tagged on egress,
- egress tagging can be changed to tag all frames, in which case only tagged frames are accepted on ingress,
- VLAN trunking may be enabled.

Hybrid:

Hybrid ports resemble trunk ports in many ways, but adds additional port configuration features. In addition to the characteristics described for trunk ports, hybrid ports have these abilities:

- Can be configured to be VLAN tag unaware, C-tag aware, S-tag aware, or S-custom-tag aware,
- ingress filtering can be controlled,
- ingress acceptance of frames and configuration of egress tagging can be configured independently.

Port VLAN:

Determines the port's VLAN ID (a.k.a. PVID). Allowed VLANs are in the range 1 through 4095, default being 1.

On ingress, frames get classified to the Port VLAN if the port is configured as VLAN unaware, the frame is untagged, or VLAN awareness is enabled on the port, but the frame is priority tagged (VLAN ID = 0).

On egress, frames classified to the Port VLAN do not get tagged if Egress Tagging configuration is set to untag Port VLAN.

The Port VLAN is called an "Access VLAN" for ports in Access mode and Native VLAN for ports in Trunk or Hybrid mode.

Port Type:

Ports in hybrid mode allow for changing the port type, that is, whether a frame's VLAN tag is used to classify the frame on ingress to a particular VLAN, and if so, which TPID it reacts on. Likewise, on egress, the Port Type determines the TPID of the tag, if a tag is required.

Unaware:

On ingress, all frames, whether carrying a VLAN tag or not, get classified to the Port VLAN, and possible tags are not removed on egress.

C-Port:

On ingress, frames with a VLAN tag with TPID = 0x8100 get classified to the VLAN ID embedded in the tag. If a frame is untagged or priority tagged, the frame gets classified to the Port VLAN. If frames must be tagged on egress, they will be tagged with a C-tag.

S-Port:

On ingress, frames with a VLAN tag with TPID = 0x8100 or 0x88A8 get classified to the VLAN ID embedded in the tag. If a frame is untagged or priority tagged, the frame gets classified to the Port VLAN. If frames must be tagged on egress, they will be tagged with an S-tag.

S-Custom-Port:

On ingress, frames with a VLAN tag with a TPID = 0x8100 or equal to the Ethertype configured for Custom-S ports get classified to the VLAN ID embedded in the tag. If a frame is untagged or priority tagged, the frame gets classified to the Port VLAN. If frames must be tagged on egress, they will be tagged with the custom S-tag.

Ingress Filtering:

Hybrid ports allow for changing ingress filtering. Access and Trunk ports always have ingress filtering enabled.

If ingress filtering is enabled (checkbox is checked), frames classified to a VLAN that the port is not a member of get discarded.

If ingress filtering is disabled, frames classified to a VLAN that the port is not a member of are accepted and forwarded to the switch engine. However, the port will never transmit frames classified to VLANs that it is not a member of.

Ingress Acceptance:

Hybrid ports allow for changing the type of frames that are accepted on ingress.

Tagged and untagged

both tagged and untagged frames are accepted.

Tagged Only

Only tagged frames are accepted on ingress. Untagged frames are discarded.

Untagged Only

Only untagged frames are accepted on ingress. Tagged frames are discarded.

Egress Tagging:

Ports in Trunk and Hybrid mode may control the tagging of frames on egress.

Untag Port VLAN

Frames classified to the Port VLAN are transmitted untagged. Other frames are transmitted with the relevant tag.

Tag All

All frames, whether classified to the Port VLAN or not, are transmitted with a tag.

Untag All

All frames, whether classified to the Port VLAN or not, are transmitted without a tag.

This option is only available for ports in Hybrid mode.

Allowed VLANs:

Ports in Trunk and Hybrid mode may control which VLANs they are allowed to become members of. Access ports can only be member of one VLAN, the Access VLAN.

The field's syntax is identical to the syntax used in the Existing VLANs field. By default, a port may become member of all possible VLANs, and is therefore set to 1-4095.

The field may be left empty, which means that the port will not be member of any of the existing VLANs, but if it is configured for VLAN Trunking it will still be able to carry all unknown VLANs.

Forbidden VLANs:

A port may be configured to never be member of one or more VLANs. This is particularly useful when dynamic VLAN protocols like MVRP and GVRP must be prevented from dynamically adding ports to VLANs.

The trick is to mark such VLANs as forbidden on the port in question. The syntax is identical to the syntax used in the Enabled VLANs field.

By default, the field is left blank, which means that the port may become a member of all possible VLANs.

■ **Buttons**

Apply:

Click to save changes.

Reset:

Click to undo any changes made locally and revert to previously saved values.

VLAN Membership

This page provides an overview of membership status of VLAN users.

The ports belong to the currently selected stack unit, as reflected by the page header.

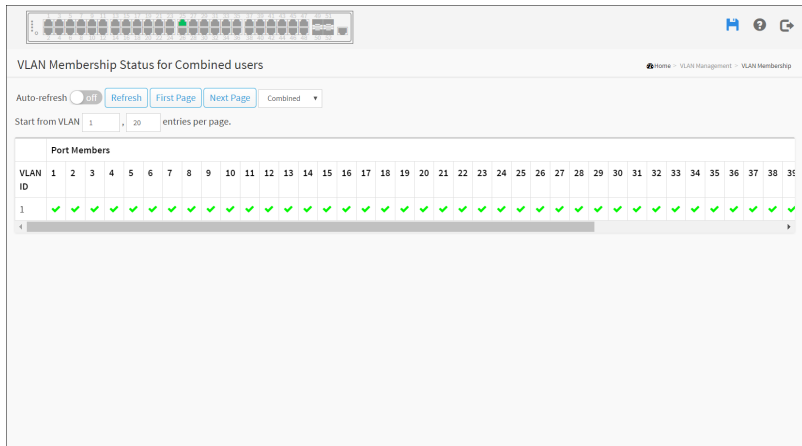

Web Interface

To configure VLAN membership configuration in the web interface:

1. Click VLAN Management and VLAN membership.
2. Scroll the bar to choice which VLANs would like to show up.
3. Click Refresh to update the state.

■ Parameter description:

VLAN USER:

Various internal software modules may use VLAN services to configure VLAN memberships on the fly.

The drop-down list on the right allows for selecting between showing VLAN memberships as configured by an administrator (Admin) or as configured by one of these internal software modules.

The “Combined” entry will show a combination of the administrator and internal software modules configuration, and basically reflects what is actually configured in hardware.

VLAN User module uses services of the VLAN management functionality to configure VLAN memberships and VLAN port configurations such as PVID and UVID. Currently we support the following VLAN user types:

NAS: NAS provides port-based authentication, which involves communications between a Supplicant, Authenticator, and an Authentication Server.

GVRP: Adjacent VLAN-aware devices can exchange VLAN information with each other by using Generic VLAN Registration Protocol (GVRP). GVRP is based on the Generic Attribute Registration Protocol (GARP) and propagates VLAN information throughout a bridged network.

MVR: MVR is used to eliminate the need to duplicate multicast traffic for subscribers in each VLAN. Multicast traffic for all channels is sent only on a single (multicast) VLAN.

Voice VLAN: Voice VLAN is a VLAN configured specially for voice traffic typically originating from IP phones.

MSTP: The 802.1s Multiple Spanning Tree protocol (MSTP) uses VLANs to create multiple spanning trees in a network, which significantly improves network resource utilization while maintaining a loop-free environment.

DMS: Shows DMS VLAN membership status.

VCL: Shows MAC-based VLAN entries configured by various MAC-based VLAN users.

VLAN ID:

VLAN ID for which the Port members are displayed.

Port Members:

A row of check boxes for each port is displayed for each VLAN ID.

If a port is included in a VLAN, an image **U** and **T** will be displayed. Shows egress filtering frame status whether tagged or untagged. Frames classified to the Port VLAN are transmitted tagged (**T**) or untagged (**U**).

VLAN Membership:

The VLAN Membership Status Page shall show the current VLAN port members for all VLANs configured by a selected VLAN User (selection shall be allowed by a Combo Box). When combined Users are selected, it shall show this information for all the VLAN Users, and this is by default. VLAN membership allows the frames classified to the VLAN ID to be forwarded on the respective VLAN member ports.

Show entries:

You can choose how many items you want to show up.

:

You can choose the Vlan User.

■ Buttons



Auto-refresh:

Check this box to refresh the page automatically. Automatic refresh occurs every 3 seconds.

Refresh:

Click to refresh the page.

First Page:

Updates the system log entries, turn to the first page.

Next Page:

Updates the system log entries, turn to the next page.

VLAN Port Status

The function Port Status gathers the information of all VLAN status and reports it by the order of Combined, Admin, NAS, GVRP, MVR, Voice VLAN, MSTP, DMS, VCL.

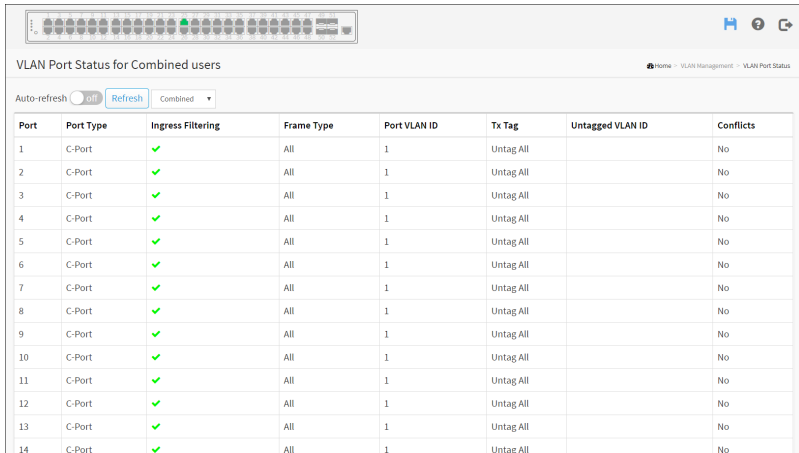

Port	Port Type	Ingress Filtering	Frame Type	Port VLAN ID	Tx Tag	Untagged VLAN ID	Conflicts
1	C-Port	✓	All	1	Untag All		No
2	C-Port	✓	All	1	Untag All		No
3	C-Port	✓	All	1	Untag All		No
4	C-Port	✓	All	1	Untag All		No
5	C-Port	✓	All	1	Untag All		No
6	C-Port	✓	All	1	Untag All		No
7	C-Port	✓	All	1	Untag All		No
8	C-Port	✓	All	1	Untag All		No
9	C-Port	✓	All	1	Untag All		No
10	C-Port	✓	All	1	Untag All		No
11	C-Port	✓	All	1	Untag All		No
12	C-Port	✓	All	1	Untag All		No
13	C-Port	✓	All	1	Untag All		No
14	C-Port	✓	All	1	Untag All		No

Web Interface

To Display VLAN Port Status in the web interface:

1. Click VLAN Management and VLAN Port Status.
2. Specify the Combined, Admin, NAS, GVRP, MVR, Voice VLAN, MSTP, DMS, VCL, RMirror.
3. Display Port Status information.

■ Parameter description:

VLAN USER:

VLAN User module uses services of the VLAN management functionality to configure VLAN memberships and VLAN port configuration such as PVID, UVID. Currently we support following VLAN User types:

NAS: NAS provides port-based authentication, which involves communications between a Supplicant, Authenticator, and an Authentication Server.

GVRP: Adjacent VLAN-aware devices can exchange VLAN information with each other by using Generic VLAN Registration Protocol (GVRP). GVRP is

based on the Generic Attribute Registration Protocol (GARP) and propagates VLAN information throughout a bridged network.

MVR: MVR is used to eliminate the need to duplicate multicast traffic for subscribers in each VLAN. Multicast traffic for all channels is sent only on a single (multicast) VLAN.

Voice VLAN: Voice VLAN is a VLAN configured specially for voice traffic typically originating from IP phones.

MSTP: The 802.1s Multiple Spanning Tree protocol (MSTP) uses VLANs to create multiple spanning trees in a network, which significantly improves network resource utilization while maintaining a loop-free environment.

DMS: Shows DMS VLAN membership status.

VCL: shows MAC-based VLAN entries configured by various MAC-based VLAN users.

Port:

The logical port for the settings contained in the same row.

Port Type:

Shows the Port Type. Port type can be any of Unaware, C-port, S-port, Custom S-port.

If Port Type is Unaware, all frames are classified to the Port VLAN ID and tags are not removed. C-port is Customer Port. S-port is Service port. Custom S-port is S-port with Custom TPID.

Ingress Filtering:

Shows the ingress filtering on a port. This parameter affects VLAN ingress processing. If ingress filtering is enabled and the ingress port is not a member of the classified VLAN, the frame is discarded.

Frame Type:

Shows whether the port accepts all frames or only tagged frames. This parameter affects VLAN ingress processing. If the port only accepts tagged frames, untagged frames received on that port are discarded.

Port VLAN ID:

Shows the Port VLAN ID (PVID) that a given user wants the port to have.

The field is empty if not overridden by the selected user.

Tx Tag:

Shows egress filtering frame status whether tagged or untagged.

Untagged VLAN ID:

If Tx Tag is overridden by the selected user and is set to Tag or Untag UVID, then this field will show the VLAN ID the user wants to tag or untag on egress. The field is empty if not overridden by the selected user.

Conflicts:

Two users may have conflicting requirements to a port's configuration. For instance, one user may require all frames to be tagged on egress while another requires all frames to be untagged on egress.

Since both users cannot win, this gives rise to a conflict, which is solved in a prioritized way. The Administrator has the least priority. Other software modules are prioritized according to their position in the drop-down list: The higher in the list, the higher priority.

If conflicts exist, it will be displayed as "Yes" for the "Combined" user and the offending software module.

The "Combined" user reflects what is actually configured in hardware.

:

You can choose the Vlan User.

■ Buttons



Auto-refresh:

Check this box to refresh the page automatically. Automatic refresh occurs every 3 seconds.

Refresh:

Click to refresh the page.

MAC-based VLAN

Configuration

The MAC address to VLAN ID mappings can be configured here. This page allows adding and deleting MAC-based VLAN Classification List entries and assigning the entries to different ports.

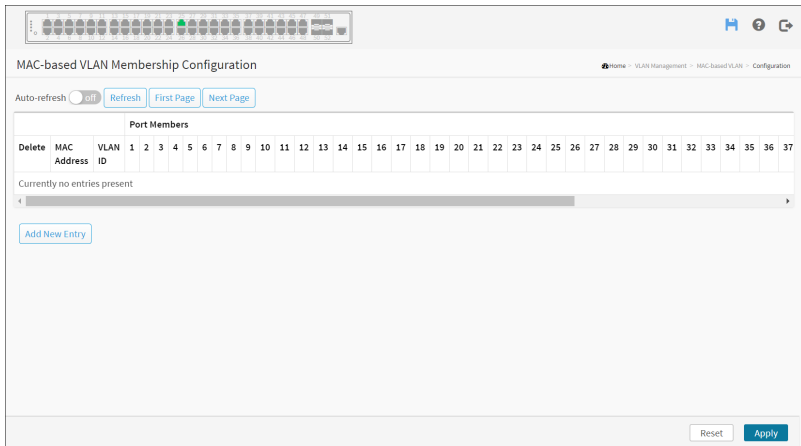

Web Interface

To configure MAC address-based VLAN configuration in the web interface:

1. Click VLAN Management, MAC-based VLAN and Configuration.
2. Click “Add New Entry”.

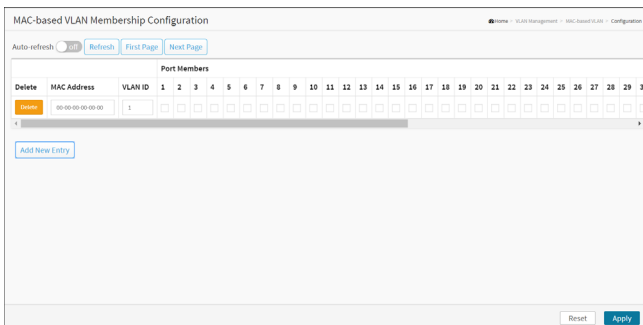

3. Specify the MAC address and VLAN ID.
4. Click Apply.

■ Parameter description:

MAC Address:

Indicates the MAC address.

VLAN ID:

Indicates the VLAN ID.

Port Members:

A row of check boxes for each port is displayed for each MAC to VLAN ID mapping entry. To include a port in the mapping, check the box. To remove or exclude the port from the mapping, make sure the box is unchecked. By default, no ports are members, and all boxes are unchecked.

■ Buttons

Adding New Entry:

Click to add a new MAC-based VLAN entry. An empty row is added to the table, and the MAC-based VLAN entry can be configured as needed. Any unicast MAC address can be configured for the MAC-based VLAN entry. No broadcast or multicast MAC addresses are allowed. Legal values for a VLAN ID are 1 through 4095.

Delete:

To delete a MAC-based VLAN entry, check this box and press apply. The entry will be deleted on the selected switch in the stack.

Apply:

Click to save changes.

Reset:

Click to undo any changes made locally and revert to previously saved values.

Buttons



Auto-refresh:

Check this box to refresh the page automatically. Automatic refresh occurs every 3 seconds.

Refresh:

Click to refresh the page.

First Page:

Updates the system log entries, turn to the first page.

Next Page:

Updates the system log entries, turn to the next page.

Status

Show the MAC-based VLAN status.



Web Interface

To Display MAC-based address VLAN configuration in the web interface:

1. Click VLAN Management, MAC-based VLAN and Status.
2. If you want to auto-refresh the information then you need to evoke the “Auto-refresh”.
3. Click “Refresh” to refresh the MAC-based VLAN Membership Status.

■ Parameter description:

MAC Address:

Indicates the MAC address.

VLAN ID:

Indicates the VLAN ID.

Port Members:

Port members of the MAC-based VLAN entry.

■ Buttons

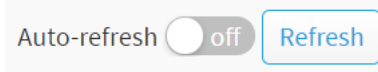

Auto-refresh:

Check this box to refresh the page automatically. Automatic refresh occurs every 3 seconds.

Refresh:

Click to refresh the page.

Protocol-based VLAN

This section describe Protocol -based VLAN, The Switch support Protocol include Ethernet LLC SNAP Protocol.

LLC

The Logical Link Control (LLC) data communication protocol layer is the upper sub-layer of the Data Link Layer (which is itself layer 2, just above the Physical Layer) in the seven-layer OSI reference model. It provides multiplexing mechanisms that make it possible for several network protocols (IP, IPX, Decent and Appletalk) to coexist within a multipoint network and to be transported over the same network media, and can also provide flow control and automatic repeat request (ARQ) error management mechanisms.

SNAP

The Subnetwork Access Protocol (SNAP) is a mechanism for multiplexing, on networks using IEEE 802.2 LLC, more protocols than can be distinguished by the 8-bit 802.2 Service Access Point (SAP) fields. SNAP supports identifying protocols by Ethernet type field values; it also supports vendor-private protocol identifier spaces. It is used with IEEE 802.3, IEEE 802.4, IEEE 802.5, IEEE 802.11 and other IEEE 802 physical network layers, as well as with non-IEEE 802 physical network layers such as FDDI that use 802.2 LLC.

Protocol to Group

This page allows you to add new protocols to Group Name (unique for each Group) mapping entries as well as allow you to see and delete already mapped entries for the selected stack switch unit switch.

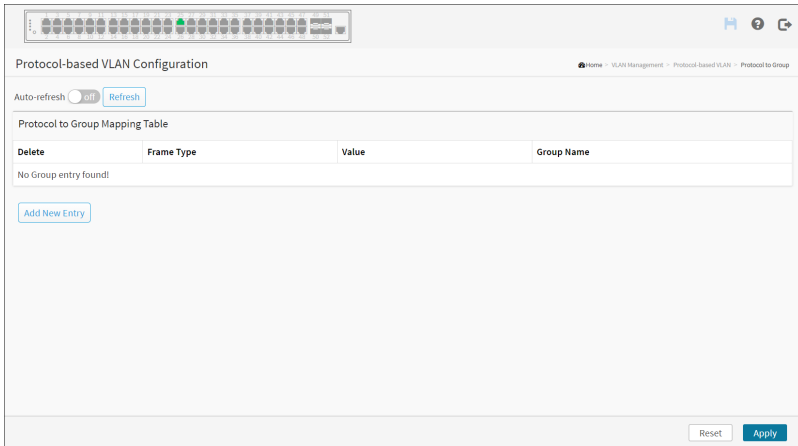

Web Interface

To configure Protocol-based VLAN configuration in the web interface:

1. Click VLAN Management, Protocol-based VLAN and Protocol to Group.
2. Click “Add New Entry”.

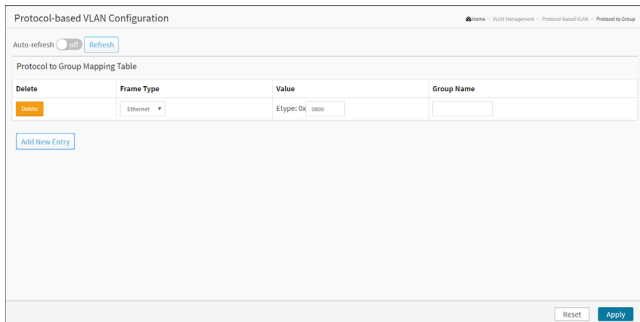

3. Specify the Frame Type, Value and Group Name.
4. Click Apply.

■ Parameter description:

Frame Type:

Frame Type can have one of the following values:

1. Ethernet
2. LLC

3. SNAP

Note: On changing the Frame type field, valid value of the following text field will vary depending on the new frame type you selected.

Value:

Valid value that can be entered in this text field depends on the option selected from the preceding Frame Type selection menu.

Below is the criteria for three different Frame Types:

1. For Ethernet: Values in the text field when Ethernet is selected as a Frame Type is called etype. Valid values for etype ranges from 0x0600-0xffff
2. For LLC: Valid value in this case is comprised of two different sub-values.
 - a. DSAP: 1-byte long string (0x00-0xff)
 - b. SSAP: 1-byte long string (0x00-0xff)
3. For SNAP: Valid value in this case also is comprised of two different sub-values.
 - a. OUI: OUI (Organizationally Unique Identifier) is value in format of xx-xx-xx where each pair (xx) in string is a hexadecimal value ranges from 0x00-0xff.
 - b. PID: If the OUI is hexadecimal 000000, the protocol ID is the Ethernet type (EtherType) field value for the protocol running on top of SNAP; if the OUI is an OUI for a particular organization, the protocol ID is a value assigned by that organization to the protocol running on top of SNAP.

Group Name:

A valid Group Name is a unique 16-character long string.

■ Buttons

Delete:

To delete a Protocol to Group Name map entry, check this box. The entry will be deleted on the switch during the next Save.

Add New Entry:

Click to add a new entry in mapping table. An empty row is added to the table; Frame Type, Value and the Group Name can be configured as needed.

The button can be used to undo the addition of new entry.

Apply:

Click to save changes.

Reset:

Click to undo any changes made locally and revert to previously saved values.

Group to VLAN

This section allows you to map an already configured Group Name to a VLAN for the selected stack switch unit switch.



Web Interface

To configure Group Name to VLAN mapping table configured in the web interface:

1. Click VLAN Management, Protocol-based VLAN and Group to VLAN.
2. Click “Add New Entry”.

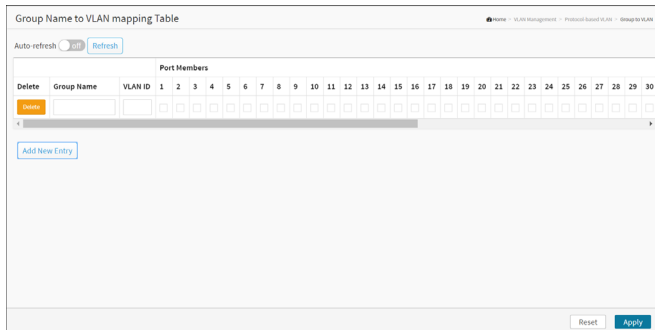

3. Specify the Group Name and VLAN ID.

4. Click Apply.

■ **Parameter description:**

Group Name:

A valid Group Name is a string of almost 16 characters.

VLAN ID:

Indicates the ID to which Group Name will be mapped. A valid VLAN ID ranges from 1-4095.

Port Members:

A row of check boxes for each port is displayed for each Group Name to VLAN ID mapping. To include a port in a mapping, check the box. To remove or exclude the port from the mapping, make sure the box is unchecked. By default, no ports are members, and all boxes are unchecked.

■ **Buttons**

Delete:

To delete a Group Name to VLAN map entry, check this box. The entry will be deleted on the switch during the next Save

Add New Entry:

Click to add a new entry in mapping table. An empty row is added to the table, the Group Name, VLAN ID and port members can be configured as needed. Legal values for a VLAN ID are 1 through 4095. The button can be used to undo the addition of new entry.

Apply:

Click to save changes.

Reset:

Click to undo any changes made locally and revert to previously saved values.

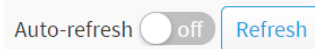

Auto-refresh:

Check this box to refresh the page automatically. Automatic refresh occurs every 3 seconds.

Refresh:

Click to refresh the page.

IP Subnet-based VLAN

The IP subnet-based VLAN entries can be configured here. This page allows for adding, updating and deleting IP subnet-based VLAN entries.

IP Subnet-based VLAN Configuration

Home - VLAN Management - IP Subnet-based VLAN

Delete	IP Address	Mask Length	VLAN ID	Port Members																															
				1	2	3	4	5	6	7	8	9	10	11	12	13	14	15	16	17	18	19	20	21	22	23	24	25	26	27	28	29	30	31	32
Currently no entries present																																			
<input type="button" value="Add New Entry"/>																																			
<input type="button" value="Reset"/> <input type="button" value="Apply"/>																																			

Web Interface

To configure IP subnet-based VLAN Membership to configured in the web interface:

1. Click VLAN Management and IP Subnet-based VLAN.
2. Click “Add New Entry”.

IP Subnet-based VLAN Configuration

Home - VLAN Management - IP Subnet-based VLAN

Delete	IP Address	Mask Length	VLAN ID	Port Members																															
				1	2	3	4	5	6	7	8	9	10	11	12	13	14	15	16	17	18	19	20	21	22	23	24	25	26	27	28				
<input type="button" value="Delete"/>	0.0.0.0	24	1	<input type="checkbox"/>	<input type="checkbox"/>	<input type="checkbox"/>	<input type="checkbox"/>	<input type="checkbox"/>	<input type="checkbox"/>	<input type="checkbox"/>	<input type="checkbox"/>	<input type="checkbox"/>	<input type="checkbox"/>	<input type="checkbox"/>	<input type="checkbox"/>	<input type="checkbox"/>	<input type="checkbox"/>	<input type="checkbox"/>	<input type="checkbox"/>	<input type="checkbox"/>	<input type="checkbox"/>	<input type="checkbox"/>	<input type="checkbox"/>	<input type="checkbox"/>	<input type="checkbox"/>	<input type="checkbox"/>	<input type="checkbox"/>	<input type="checkbox"/>	<input type="checkbox"/>	<input type="checkbox"/>	<input type="checkbox"/>	<input type="checkbox"/>	<input type="checkbox"/>	<input type="checkbox"/>	<input type="checkbox"/>
<input type="button" value="Add New Entry"/>																																			
<input type="button" value="Reset"/> <input type="button" value="Apply"/>																																			

3. Specify IP Address, Mask Length, VLAN ID.
4. Click Apply.

■ Parameter description:

IP Address:

Indicates the IP address.

Mask Length:

Indicates the network mask length.

VLAN ID:

Indicates the VLAN ID. VLAN ID can be changed for the existing entries.

Port Members:

A row of check boxes for each port is displayed for each IP subnet to VLAN ID mapping entry. To include a port in a mapping, simply check the box. To remove or exclude the port from the mapping, make sure the box is unchecked. By default, no ports are members and all boxes are unchecked.

■ Buttons

Delete:

To delete a IP subnet-based VLAN entry, check this box and press save. The entry will be deleted on the selected switch in the stack.

Add New Entry:

Click “Add New Entry” to add a new IP subnet-based VLAN entry. An empty row is added to the table, and the IP subnet-based VLAN entry can be configured as needed. Any IP address/mask can be configured for the IP subnet-based VLAN entry. Legal values for a VLAN ID are 1 through 4095.

The IP subnet-based VLAN entry is enabled on the selected stack switch unit when you click on "Save". The “Delete” button can be used to undo the addition of new IP subnet-based VLANs. The maximum possible IP subnet-based VLAN entries are limited to 128.

Apply:

Click to save changes.

Reset:

Click to undo any changes made locally and revert to previously saved values.

GVRP

The Generic Attribute Registration Protocol (GARP) provides a generic framework whereby devices in a bridged LAN, e.g. end stations and switches, can register and de-register attribute values, such as VLAN Identifiers, with each other. In doing so, the attributes are propagated to devices in the bridged LAN, and these devices form a $\text{jo}^{\circ}\text{reachability}_{\pm}$ tree that is a subset of an active topology. GARP defines the architecture, rules of operation, state machines and variables for the registration and de-registration of attribute values.

A GARP participation in a switch or an end station consists of a GARP application component, and a GARP Information Declaration (GID) component associated with each port or the switch. The propagation of information between GARP participants for the same application in a bridge is carried out by the GARP Information Propagation (GIP) component. Protocol exchanges take place between GARP participants by means of LLC Type 1 services, using the group MAC address and PDU format defined for the GARP application concerned.

The screenshot displays the GVRP Port Configuration web interface. At the top, there is a navigation bar with a home icon, a refresh icon, and a back icon. The main title is "GVRP Port Configuration" with a breadcrumb trail: "Home > VLAN Management > GVRP".

The configuration is divided into two main sections:

- Global GVRP Settings:**
 - Enable GVRP:** A toggle switch currently set to "Off".
 - Parameter Table:**

Parameter	Value
Join-time:	20 (1-20)
Leave-time:	60 (60-300)
LeaveAll-time:	1000 (1000-5000)
Max VLANs:	20
- GVRP Port Configuration:**
 - Port Table:**

Port	Mode
1	Disabled
2	Disabled

At the bottom right of the configuration area, there are two buttons: "Reset" and "Apply".

Web Interface

To configure the GVRP in the web interface:

1. Click VLAN Management and GVRP.
2. Evoke to enable or disable the GVRP.
3. Specify Join-time, Leave-time, Leave All-time, Max VLANs.
4. Evoke to enable or disable the Mode.

5. Click apply to save the setting.
6. If you want to cancel the setting then you need to click the Reset button. It will revert to previously saved values.

■ **Parameter description:**

Enable GVRP globally:

The GVRP feature is enabled by setting the check mark in the checkbox named Enable GVRP.

GVRP protocol timers:

Join-time is a value in the range 1-20 in the units of centi seconds, i.e. in units of one hundredth of a second. The default is 20.

Leave-time is a value in the range 60-300 in the units of centi seconds, i.e. in units of one hundredth of a second. The default is 60.

Leave All-time is a value in the range 1000-5000 in the units of centi seconds, i.e. in units of one hundredth of a second. The default is 1000.

Max VLANs:

When GVRP is enabled a maximum number of VLANs supported by GVRP is specified. By default this number is 20. This number can only be changed when GVRP is turned off.

Port:

The Port column shows the list of ports.

Mode:

This configuration is to enable/disable GVRP Mode on particular port locally.

Disable: Select to Disable GVRP mode on this port.

GVRP Enable: Select to Enable GVRP mode on this port.

■ **Buttons**

Apply:

Click to save changes.

Reset:

Click to undo any changes made locally and revert to previously saved values.

Private VLAN

The Private VLAN membership configurations for the switch can be monitored and modified here. Private VLANs can be added or deleted here. Port members of each Private VLAN can be added or removed here.

Private VLANs are based on the source port mask, and there are no connections to VLANs. This means that VLAN IDs and Private VLAN IDs can be identical.

A port must be a member of both a VLAN and a Private VLAN to be able to forward packets. By default, all ports are VLAN unaware and members of VLAN 1 and Private VLAN 1.

A VLAN unaware port can only be a member of one VLAN, but it can be a member of multiple Private VLANs.

VLAN Priority: Voice VLAN > MAC based VLAN > Protocol based VLAN > Tag based VLAN

Private VLAN Membership Configuration

Auto-refresh Refresh

Private VLAN Membership Configuration

Port Members		1	2	3	4	5	6	7	8	9	10	11	12	13	14	15	16	17	18	19	20	21	22	23	24	25	26	27	28	29	30	31	32	33	34	35
Delete	PVID	1	2	3	4	5	6	7	8	9	10	11	12	13	14	15	16	17	18	19	20	21	22	23	24	25	26	27	28	29	30	31	32	33	34	35
<input type="checkbox"/>	1	<input checked="" type="checkbox"/>	<input checked="" type="checkbox"/>	<input checked="" type="checkbox"/>	<input checked="" type="checkbox"/>	<input checked="" type="checkbox"/>	<input checked="" type="checkbox"/>	<input checked="" type="checkbox"/>	<input checked="" type="checkbox"/>	<input checked="" type="checkbox"/>	<input checked="" type="checkbox"/>	<input checked="" type="checkbox"/>	<input checked="" type="checkbox"/>	<input checked="" type="checkbox"/>	<input checked="" type="checkbox"/>	<input checked="" type="checkbox"/>	<input checked="" type="checkbox"/>	<input checked="" type="checkbox"/>	<input checked="" type="checkbox"/>	<input checked="" type="checkbox"/>	<input checked="" type="checkbox"/>	<input checked="" type="checkbox"/>	<input checked="" type="checkbox"/>	<input checked="" type="checkbox"/>	<input checked="" type="checkbox"/>	<input checked="" type="checkbox"/>	<input checked="" type="checkbox"/>	<input checked="" type="checkbox"/>	<input checked="" type="checkbox"/>	<input checked="" type="checkbox"/>	<input checked="" type="checkbox"/>	<input checked="" type="checkbox"/>	<input checked="" type="checkbox"/>	<input checked="" type="checkbox"/>	<input checked="" type="checkbox"/>	

Add New Private VLAN

Reset Apply

Web Interface

To configure Port Isolation configuration in the web interface:

1. Click VLAN Management and Private VLAN.
2. Configure the Private VLAN membership configurations for the switch.
3. Click Apply.

■ Parameter description:

Delete:

To delete a private VLAN entry, check this box. The entry will be deleted during the next apply.

Private VLAN ID:

Indicates the ID of this particular private VLAN.

Port Members:

A row of check boxes for each port is displayed for each private VLAN ID. To include a port in a Private VLAN, check the box. To remove or exclude the port from the Private VLAN, make sure the box is unchecked. By default, no ports are members, and all boxes are unchecked.

Add New Private VLAN:

Click to add a new private VLAN ID. An empty row is added to the table, and the private VLAN can be configured as needed. The allowed range for a private VLAN ID is the same as the switch port number range. Any values outside this range are not accepted, and a warning message appears. Click “OK” to discard the incorrect entry, or click “Cancel” to return to the editing and make a correction.

The Private VLAN is enabled when you click “Apply”.

The button can be used to undo the addition of new Private VLANs.

Buttons

Apply:

Click to save changes.

Reset:

Click to undo any changes made locally and revert to previously saved values.

Port Isolation

Port Isolation provides for an apparatus and method to isolate ports on layer 2 switches on the same VLAN to restrict traffic flow. The apparatus comprises a switch having said plurality of ports, each port configured as a protected port or a non-protected port. An address table memory stores an address table having a destination address and port number pair. A forwarding map generator generates a forwarding map which is responsive to a destination address of a data packet. The method for isolating ports on a layer 2 switch comprises configuring each of the ports on the layer 2 switch as a protected port or a non-protected port. A destination address on a data packet is matched with a physical address on said layer 2 switch and a forwarding map is generated for the data packet based upon the destination address on the data packet. The data packet is then sent to the plurality of ports pursuant to the forwarding map generated based upon whether the ingress port was configured as a protected or non-protected port.

This page is used for enabling or disabling port isolation on ports in a Private VLAN. A port member of a VLAN can be isolated to other isolated ports on the same VLAN and Private VLAN.



Web Interface

To configure Port Isolation configuration in the web interface:

1. Click VLAN Management and Port Isolation.
2. Evoke which port want to enable Port Isolation
3. Click Apply.

■ Parameter description:

Port Numbers:

A check box is provided for each port of a private VLAN. When checked, port isolation is enabled on that port. When unchecked, port isolation is disabled on that port. By default, port isolation is disabled on all ports.

■ Buttons

Apply:

Click to save changes.

Reset:

Click to undo any changes made locally and revert to previously saved values.

Voice VLAN

Voice VLAN is VLAN configured specially for voice traffic. By adding the ports with voice devices attached to voice VLAN, we can perform QoS-related configuration for voice data, ensuring the transmission priority of voice traffic and voice quality.

Configuration

The Voice VLAN feature enables voice traffic forwarding on the Voice VLAN, then the switch can classify and schedule network traffic. It is recommended that there be two VLANs on a port - one for voice, one for data. Before connecting the IP device to the switch, the IP phone should configure the voice VLAN ID correctly. It should be configured through its own GUI.

Voice VLAN Configuration

Mode Off

VLAN ID

Aging Time seconds

Traffic

Port	Mode	Security	Discovery Protocol
*	Disabled	--	--
1	Disabled	Disabled	OUI
2	Disabled	Disabled	OUI
3	Disabled	Disabled	OUI

Reset Apply

Web Interface

To configure Voice VLAN in the web interface:

1. Click VLAN Management, Voice VLAN and Configuration.
2. Select “on” in the Voice VLAN Configuration.
3. Specify VLAN ID, Aging Time and Traffic Class.
4. Select Port Members in the Voice VLAN Configuration.
5. Specify (Mode, Security, Discovery Protocol) in the Port Configuration.
6. Click the Apply to save the setting.

7. If you want to cancel the setting then you need to click the Reset button. It will revert to previously saved values.

■ **Parameter description:**

Mode:

Indicates the Voice VLAN mode operation. We must disable MSTP feature before we enable Voice VLAN. It can avoid the conflict of ingress filtering. Possible modes are:

on: Enable Voice VLAN mode operation.

off: Disable Voice VLAN mode operation.

VLAN ID:

Indicates the Voice VLAN ID. It should be a unique VLAN ID in the system and cannot equal each port PVID. It is a conflict in configuration if the value equals management VID, MVR VID, PVID etc. The allowed range is 1 to 4095.

Aging Time:

Indicates the Voice VLAN secure learning aging time. The allowed range is 10 to 10000000 seconds. It is used when security mode or auto detect mode is enabled. In other cases, it will be based on hardware aging time. The actual aging time will be situated between the [age_time; 2 * age_time] interval.

Traffic:

Indicates the Voice VLAN traffic class. All traffic on the Voice VLAN will apply this class.

Port:

The switch port number of the Voice VLAN port.

Port Mode:

Indicates the Voice VLAN port mode. Possible port modes are:

Disabled: Disjoin from Voice VLAN.

Auto: Enable auto detect mode. It detects whether there is VoIP phone attached to the specific port and configures the Voice VLAN members automatically.

Forced: Force join to Voice VLAN.

This field will be read only if STP feature is enabled. And the STP port mode will be readonly if this field be set to the mode other than Disabled.

Port Security:

Indicates the Voice VLAN port security mode. When the function is enabled, all non-telephonic MAC addresses in the Voice VLAN will be blocked for 10 seconds. Possible port modes are:

Enabled: Enable Voice VLAN security mode operation.

Disabled: Disable Voice VLAN security mode operation.

Port Discovery Protocol

Indicates the Voice VLAN port discovery protocol. It will only work when auto detect mode is enabled. We should enable LLDP feature before configuring discovery protocol to “LLDP” or “Both”. Changing the discovery protocol to “OUI” or “LLDP” will restart auto detect process. Possible discovery protocols are:

OUI: Detect telephony device by OUI address.

LLDP: Detect telephony device by LLDP.

Both: Both OUI and LLDP.

■ Buttons

Apply:

Click to save changes.

Reset:

Click to undo any changes made locally and revert to previously saved values.

OUI

The section describes to Configure VOICE VLAN OUI table. The maximum entry number is 16. Modifying the OUI table will restart auto detection of OUI process.

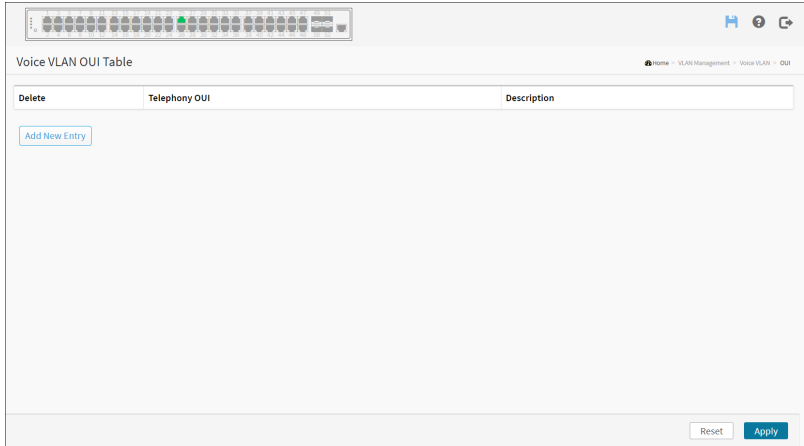

Web Interface

To configure Voice VLAN OUI Table in the web interface:

1. Click VLAN Management, Voice VLAN and OUI.
2. Select “Add new entry”, “delete” in the Voice VLAN OUI table.

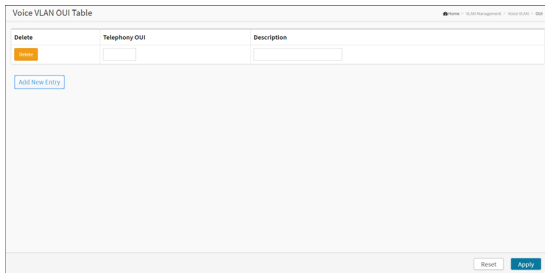

3. Specify Telephony OUI, Description.
4. Click Apply.

■ Parameter description:

Delete:

Check to delete the entry. It will be deleted during the next save.

Telephony OUI:

A telephony OUI address is a globally unique identifier assigned to a vendor by IEEE. It must be 6 characters long and the input format is "xx-xx-xx" (x is a hexadecimal digit).

Description:

The description of OUI address. Normally, it describes which vendor telephony device it belongs to. The allowed string length is 0 to 32.

Add New entry:

Click to add a new entry in Voice VLAN OUI table. An empty row is added to the table, the Telephony OUI, Description.

■ **Buttons**

Apply:

Click to save changes.

Reset:

Click to undo any changes made locally and revert to previously saved values.

Chapter 7

Quality of Server (QoS)

Overview

The switch support four QoS queues per port with strict or weighted fair queuing scheduling. It supports QoS Control Lists (QCL) for advance programmable QoS classification, based on IEEE 802.1p, Ethertype, VID, IPv4/IPv6 DSCP and UDP/TCP ports and ranges.

High flexibility in the classification of incoming frames to a QoS class. The QoS classification looks for information up to Layer 4, including IPv4 and IPv6 DSCP, IPv4 TCP/UDP port numbers, and user priority of tagged frames. This QoS classification mechanism is implemented in a QoS control list (QCL). The QoS class assigned to a frame is used throughout the device for providing queuing, scheduling, and congestion control guarantees to the frame according to what was configured for that specific QoS class.

The switch support advanced memory control mechanisms providing excellent performance of all QoS classes under any traffic scenario, including jumbo frame. A super priority queue with dedicated memory and strict highest priority in the arbitration. The ingress super priority queue allows traffic recognized as CPU traffic to be received and queued for transmission to the CPU even when all the QoS class queues are congested.

The menu and the submenu are shown below:

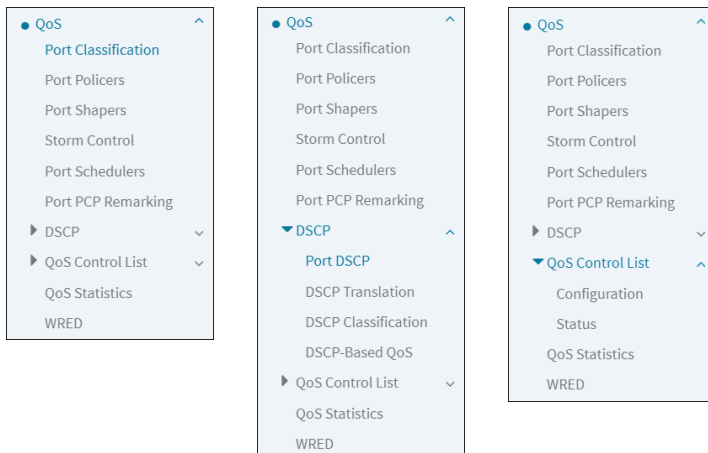

Port Classification

The section allows you to configure the basic QoS Ingress Classification settings for all switch ports.

Port	Queue Priority (7 is the highest priority)	DPL	PCP	DEI	PCP Classification	DSCP Based	WRED Group
*	0 ▼	0 ▼	0 ▼	0 ▼		<input type="checkbox"/>	0 ▼
1	0 ▼	0 ▼	0 ▼	0 ▼	Disabled	<input type="checkbox"/>	1 ▼
2	0 ▼	0 ▼	0 ▼	0 ▼	Disabled	<input type="checkbox"/>	1 ▼
3	0 ▼	0 ▼	0 ▼	0 ▼	Disabled	<input type="checkbox"/>	1 ▼
4	0 ▼	0 ▼	0 ▼	0 ▼	Disabled	<input type="checkbox"/>	1 ▼
5	0 ▼	0 ▼	0 ▼	0 ▼	Disabled	<input type="checkbox"/>	1 ▼
6	0 ▼	0 ▼	0 ▼	0 ▼	Disabled	<input type="checkbox"/>	1 ▼
7	0 ▼	0 ▼	0 ▼	0 ▼	Disabled	<input type="checkbox"/>	1 ▼
8	0 ▼	0 ▼	0 ▼	0 ▼	Disabled	<input type="checkbox"/>	1 ▼
9	0 ▼	0 ▼	0 ▼	0 ▼	Disabled	<input type="checkbox"/>	1 ▼
10	0 ▼	0 ▼	0 ▼	0 ▼	Pre-queued	<input type="checkbox"/>	1 ▼

Web Interface

To configure the QoS Ingress Port Classification parameters in the web interface:

1. Click Quality of Service and Port Classification.
2. Scroll to select QoS Ingress Port parameters.
3. Click the Apply to save the setting.
4. If you want to cancel the setting then you need to click the Reset button. It will revert to previously saved values.
5. Click “PCP Classification” to next page “Port PCP Classification”.

■ Parameter description:

Port:

The port number for which the configuration below applies.

Queue Priority:

Controls the default CoS value.

All frames are classified to a CoS. There is a one to one mapping between CoS, queue and priority. A CoS of 0 (zero) has the lowest priority.

If the port is VLAN aware, the frame is tagged and Tag Class. is enabled, then the frame is classified to a CoS that is mapped from the PCP and DEI value in the tag. Otherwise the frame is classified to the default CoS.

The classified CoS can be overruled by a QCL entry.

Note: If the default CoS has been dynamically changed, then the actual default CoS is shown in parentheses after the configured default CoS.

DPL:

Controls the default drop precedence level.

All frames are classified to a drop precedence level.

If the port is VLAN aware, the frame is tagged and Tag Class. is enabled, then the frame is classified to a DPL that is mapped from the PCP and DEI value in the tag. Otherwise the frame is classified to the default DPL.

The classified DPL can be overruled by a QCL entry.

PCP:

Controls the default PCP value.

All frames are classified to a PCP value.

If the port is VLAN aware and the frame is tagged, then the frame is classified to the PCP value in the tag. Otherwise the frame is classified to the default PCP value.

DEI:

Controls the default DEI value.

All frames are classified to a DEI value.

If the port is VLAN aware and the frame is tagged, then the frame is classified to the DEI value in the tag. Otherwise the frame is classified to the default DEI value.

DSCP Based:

Click to Enable DSCP Based QoS Ingress Port Classification.

WRED Group:

Controls the WRED group membership.

■ Buttons

Apply:

Click to save changes.

Reset:

Click to undo any changes made locally and revert to previously saved values.

PCP Classification:

Shows the classification mode for tagged frames on this port.

Disabled: Use default CoS and DPL for tagged frames.

Enabled: Use mapped versions of PCP and DEI for tagged frames.

Click on the mode in order to configure the mode and/or mapping.

Note: This setting has no effect if the port is VLAN unaware. Tagged frames received on VLAN unaware ports are always classified to the default CoS and DPL.

Port PCP Classification

Ingress Port PCP Classification Port 26 Home > QoS > Port Classification

Port 26 ▾

Tagged Frames Settings

PCP Classification Disabled ▾

(PCP, DEI) to (Queue Priority, DP level) Mapping

PCP	DEI	Queue Priority	DP level
*	*	↔ ▾	↔ ▾
0	0	1 ▾	0 ▾
0	1	1 ▾	1 ▾
1	0	0 ▾	0 ▾
1	1	0 ▾	1 ▾
2	0	2 ▾	0 ▾
2	1	2 ▾	1 ▾
3	0	3 ▾	0 ▾
3	1	3 ▾	1 ▾
4	0	4 ▾	0 ▾
4	1	4 ▾	1 ▾
5	0	5 ▾	0 ▾
5	1	5 ▾	1 ▾
6	0	6 ▾	0 ▾
6	1	6 ▾	1 ▾
7	0	7 ▾	0 ▾
7	1	7 ▾	1 ▾

■ Parameter description:

PCP Classification

Controls the classification mode for tagged frames on this port.

Disabled: Use default CoS and DPL for tagged frames.

Enabled: Use mapped versions of PCP and DEI for tagged frames.

(PCP, DEI) to (Queue Priority, DPL level) Mapping

Controls the mapping of the classified (PCP, DEI) to (Queue Priority, DPL level) values when Tag Classification is set to Enabled.

■ Buttons

Apply:

Click to save changes.

Reset:

Click to undo any changes made locally and revert to previously saved values.

Cancel:

Click to undo any changes made locally and return to the previous page.

Port Policers

This section provides an overview of QoS Ingress Port Policers for all switch ports. The Port Policing is useful in constraining traffic flows and marking frames above specific rates. Policing is primarily useful for data flows and voice or video flows because voice and video usually maintains a steady rate of traffic.

Port	Enable	Rate	Unit	Flow Control
*	<input type="checkbox"/>	500	<-	<input type="checkbox"/>
1	<input type="checkbox"/>	500	kbps	<input type="checkbox"/>
2	<input type="checkbox"/>	500	kbps	<input type="checkbox"/>
3	<input type="checkbox"/>	500	kbps	<input type="checkbox"/>
4	<input type="checkbox"/>	500	kbps	<input type="checkbox"/>
5	<input type="checkbox"/>	500	kbps	<input type="checkbox"/>
6	<input type="checkbox"/>	500	kbps	<input type="checkbox"/>
7	<input type="checkbox"/>	500	kbps	<input type="checkbox"/>
8	<input type="checkbox"/>	500	kbps	<input type="checkbox"/>
9	<input type="checkbox"/>	500	kbps	<input type="checkbox"/>
10	<input type="checkbox"/>	500	kbps	<input type="checkbox"/>

Reset Apply

Web Interface

To configure the QoS Port Policers in the web interface:

1. Click Quality of Service and Port Policers.
2. Click which port need to enable the QoS Ingress Port Policers, and configure the Rate limit condition.
3. Scroll to select the column Rate and Unit.
4. Click Apply to save the configuration.
5. If you want to cancel the setting then you need to click the Reset button. It will revert to previously saved values.

■ Parameter description:

Port:

The logical port for the settings contained in the same row. Click on the port number in order to configure the schedulers.

Enabled:

To evoke which Port you need to enable the QoS Ingress Port Policers function.

Rate:

To set the Rate limit value for this port, the default is 1000000.

Unit:

Controls the unit of measure for the port policer rate as kbps, Mbps, fps or kfps.

Flow Control:

If flow control is enabled and the port is in flow control mode, then pause frames are sent instead of discarding frames.

■ **Buttons**

Apply:

Click to save changes.

Reset:

Click to undo any changes made locally and revert to previously saved values.

Port Shapers

This section provides an overview of QoS Egress Port Shapers for all switch ports. Other users could get all detail information of the ports belong to the currently selected stack unit, as reflected by the page header.

QoS Egress Port Shapers

Home > QoS > Port Shapers

Port: Port 1

Queue	Enable	Rate	Unit
0	<input type="checkbox"/>	500	kbps
1	<input type="checkbox"/>	500	kbps
2	<input type="checkbox"/>	500	kbps
3	<input type="checkbox"/>	500	kbps
4	<input type="checkbox"/>	500	kbps
5	<input type="checkbox"/>	500	kbps
6	<input type="checkbox"/>	500	kbps
7	<input type="checkbox"/>	500	kbps

Port Shaper

Enable	Rate (kbps)	Rate-type
<input type="checkbox"/>	500	Line

Reset Apply

Web Interface

To configure the QoS Port Shapers in the web interface:

1. Click Quality of Service and Port Shapers.
2. Click the Port and display the QoS Egress Port Shapers.
3. Scroll the Port and Scheduler Mode and specify the Queue Shaper parameter.
4. Click the Apply to save the setting.
5. If you want to cancel the setting then you need to click the Reset button. It will revert to previously saved values.

■ Parameter description:

Port:

The logical port for the settings contained in the same row. Click on the port number in order to configure the shapers.

Shapers – Qn:

Shows disabled or actual queue shaper rate - e.g. “800 Mbps”.

Shapers – Port:

Shows disabled or actual port shaper rate - e.g. “800 Mbps”.

Scheduler Mode:

Controls how many of the queues are scheduled as strict and how many are scheduled as weighted on this switch port.

Queue Shaper Enable:

Controls whether the queue shaper is enabled for this queue on this switch port.

Queue Shaper Rate:

Controls the rate for the queue shaper. This value is restricted to 100-13107100 when “Unit” is kbps, and 1-13107 when “Unit” is Mbps. The rate is internally rounded up to the nearest value supported by the queue shaper.

Queue Shaper Unit:

Controls the unit of measure for the queue shaper rate as kbps or Mbps.

Queue Shaper Rate-type:

The rate type of the queue shaper. The allowed values are:

Line: Specify that this shaper operates on line rate.

Data: Specify that this shaper operates on data rate.

Queue Scheduler Weight:

Controls the weight for this queue. This value is restricted to 1-100. This parameter is only shown if “Scheduler Mode” is set to “Weighted”.

Queue Scheduler Percent:

Shows the weight in percent for this queue. This parameter is only shown if “Scheduler Mode” is set to “Weighted”.

Port Shaper Enable:

Controls whether the port shaper is enabled for this switch port.

Port Shaper Rate:

Controls the rate for the port shaper. This value is restricted to 100-13107100 when “Unit” is kbps, and 1-13107 when “Unit” is Mbps. The rate is internally rounded up to the nearest value supported by the port shaper.

Port Shaper Unit:

Controls the unit of measure for the port shaper rate as kbps or Mbps.

Port Shaper Rate-type:

The rate type of the port shaper. The allowed values are:

Line: Specify that this shaper operates on line rate.

Data: Specify that this shaper operates on data rate.

■ **Buttons**

Apply:

Click to save changes.

Reset:

Click to undo any changes made locally and revert to previously saved values.

Storm Control

The section allows user to configure the Storm control for the switch. There is a destination lookup failure storm rate control, multicast storm rate control, and a broadcast storm rate control. These only affect flooded frames, i.e. frames with a (VLAN ID, DMAC) pair not present on the MAC Address table. The configuration indicates the permitted packet rate for unicast, multicast or broadcast traffic across the switch.

Global Storm Policer Configuration			
Frame Type	Enable	Rate	Unit
Unicast	<input type="checkbox"/>	10	fps
Multicast	<input type="checkbox"/>	10	fps
Broadcast	<input type="checkbox"/>	10	fps

Port Storm Policer Configuration									
Port	Unicast Frames			Broadcast Frames			Unknown Frames		
	Enable	Rate	Unit	Enable	Rate	Unit	Enable	Rate	Unit
*	<input type="checkbox"/>	500	kbps	<input type="checkbox"/>	500	kbps	<input type="checkbox"/>	500	kbps
1	<input checked="" type="checkbox"/>	500	kbps	<input type="checkbox"/>	500	kbps	<input type="checkbox"/>	500	kbps
2	<input type="checkbox"/>	500	kbps	<input type="checkbox"/>	500	kbps	<input type="checkbox"/>	500	kbps
3	<input type="checkbox"/>	500	kbps	<input type="checkbox"/>	500	kbps	<input type="checkbox"/>	500	kbps

Web Interface

To configure the Storm Control Configuration parameters in the web interface:

1. Click Quality of Service and Storm Control.
2. Evoke to select the frame type to enable storm control.
3. Scroll to set the Rate Parameters and Unit.
4. Click which port need to enable, and configure the Rate limit condition.
5. Click the Apply to save the setting.
6. If you want to cancel the setting then you need to click the Reset button. It will revert to previously saved values.

■ Parameter description:

Global Storm Policer Configuration

Global storm policers for the switch are configured on this page.

There is a unicast storm policer, multicast storm policer, and a broadcast storm policer.

These only affect flooded frames, i.e. frames with a (VLAN ID, DMAC) pair not present in the MAC Address table.

Frame Type:

The frame type for which the configuration below applies.

Enable:

Enable or disable the global storm policer for the given frame type.

Rate:

Controls the rate for the global storm policer. This value is restricted to 10-13128147 when "Unit" is fps or kbps, and 1-13128 when "Unit" is kfps or Mbps. The rate is internally rounded up to the nearest value supported by the global storm policer. Supported rates are divisible by 10 fps or 25 kbps.

Unit:

Controls the unit of measure for the global storm policer rate as fps, kfps, kbps or Mbps.

Port Storm Policer Configuration Help

Port storm policers for all switch ports are configured on this page.

There is a storm policer for known and unknown unicast frames, known and unknown broadcast frames and unknown (flooded) unicast, multicast and broadcast frames.

Port:

The port number for which the configuration below applies.

Enable:

Enable or disable the storm policer for this switch port.

Rate:

Controls the rate for the port storm policer. This value is restricted to 10-13128147 when "Unit" is fps or kbps, and 1-13128 when "Unit" is kfps or Mbps. The rate is internally rounded up to the nearest value supported by the port storm policer. Supported rates are divisible by 10 fps or 25 kbps.

Unit:

Controls the unit of measure for the port storm policer rate as fps, kfps, kbps or Mbps.

■ **Buttons**

Apply:

Click to save changes.

Reset:

Click to undo any changes made locally and revert to previously saved values.

Port Scheduler

This section provides an overview of QoS Egress Port Scheduler for all switch ports. and the ports belong to the currently selected stack unit, as reflected by the page header.

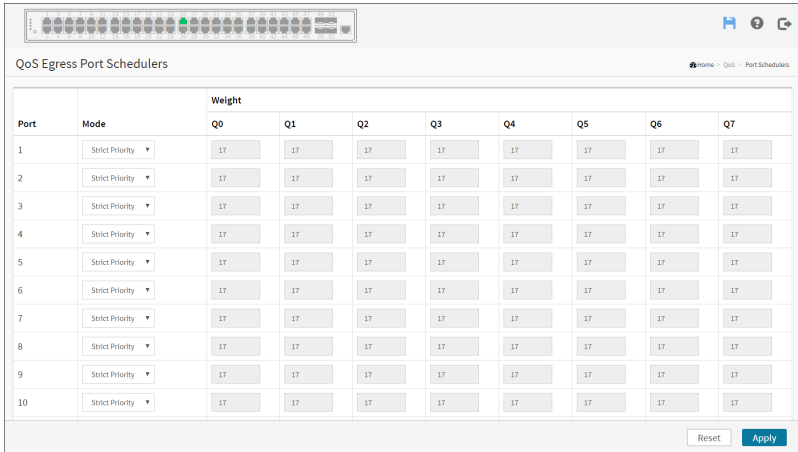

Port	Mode	Weight									
		Q0	Q1	Q2	Q3	Q4	Q5	Q6	Q7		
1	Strict Priority	17	17	17	17	17	17	17	17	17	
2	Strict Priority	17	17	17	17	17	17	17	17	17	
3	Strict Priority	17	17	17	17	17	17	17	17	17	
4	Strict Priority	17	17	17	17	17	17	17	17	17	
5	Strict Priority	17	17	17	17	17	17	17	17	17	
6	Strict Priority	17	17	17	17	17	17	17	17	17	
7	Strict Priority	17	17	17	17	17	17	17	17	17	
8	Strict Priority	17	17	17	17	17	17	17	17	17	
9	Strict Priority	17	17	17	17	17	17	17	17	17	
10	Strict Priority	17	17	17	17	17	17	17	17	17	

Web Interface

To configure the QoS Port Schedulers in the web interface:

1. Click Quality of Service and Port Scheduler.
2. Click the Port and display the QoS Egress Port Schedulers.
3. Scroll Port and Scheduler Mode, specify the Queue Shaper parameter.
4. Click the Apply to save the setting.
5. If you want to cancel the setting then you need to click the Reset button. It will revert to previously saved values.

■ Parameter description:

Port:

The logical port for the settings contained in the same row.

Mode:

Shows the scheduling mode for this port.

Qn:

Shows the weight for this queue and port.

Scheduler Mode:

Controls how many of the queues are scheduled as strict and how many are scheduled as weighted on this switch port.

Queue Shaper Enable:

Controls whether the queue shaper is enabled for this queue on this switch port.

Queue Shaper Rate:

Controls the rate for the queue shaper. This value is restricted to 100-13107100 when “Unit” is kbps, and 1-13107 when “Unit” is Mbps. The rate is internally rounded up to the nearest value supported by the queue shaper.

Queue Shaper Unit:

Controls the unit of measure for the queue shaper rate as kbps or Mbps.

Queue Shaper Rate-type:

The rate type of the queue shaper. The allowed values are:

Line: Specify that this shaper operates on line rate.

Data: Specify that this shaper operates on data rate.

Queue Scheduler Weight:

Controls the weight for this queue. This value is restricted to 1-100. This parameter is only shown if “Scheduler Mode” is set to “Weighted”.

Queue Scheduler Percent:

Shows the weight in percent for this queue. This parameter is only shown if “Scheduler Mode” is set to “Weighted”.

Port Shaper Enable:

Controls whether the port shaper is enabled for this switch port.

Port Shaper Rate:

Controls the rate for the port shaper. This value is restricted to 100-13107100 when “Unit” is kbps, and 1-13107 when “Unit” is Mbps. The rate is internally rounded up to the nearest value supported by the port shaper.

Port Shaper Unit:

Controls the unit of measure for the port shaper rate as kbps or Mbps.

Port Shaper Rate-type

The rate type of the port shaper. The allowed values are:

Line: Specify that this shaper operates on line rate.

Data: Specify that this shaper operates on data rate.

■ **Buttons**

Apply:

Click to save changes.

Reset:

Click to undo any changes made locally and revert to previously saved values.

Port PCP Remarking

The Section provides user to get an overview of QoS Egress Port PCP Remarking for all switch ports. Others the ports belong to the currently selected stack unit, as reflected by the page header.

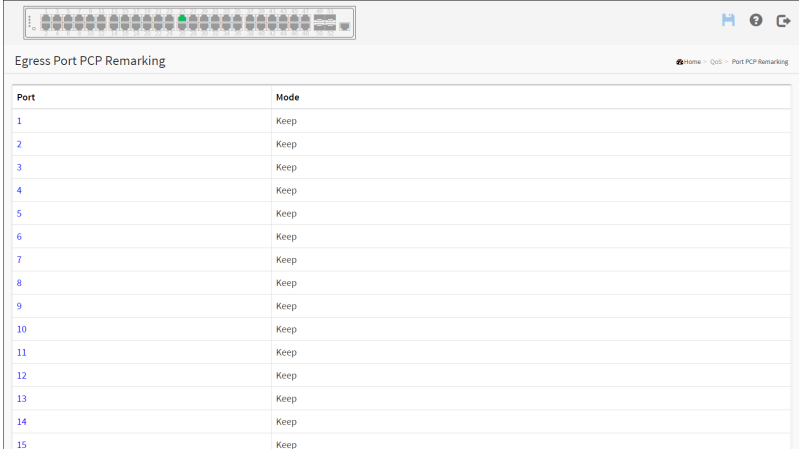

Port	Mode
1	Keep
2	Keep
3	Keep
4	Keep
5	Keep
6	Keep
7	Keep
8	Keep
9	Keep
10	Keep
11	Keep
12	Keep
13	Keep
14	Keep
15	Keep

Web Interface

To configure the QoS Port PCP Remarking in the web interface:

1. Click Quality of Service and Port PCP Remarking.
2. Click the Port and display the QoS Port PCP Remarking.

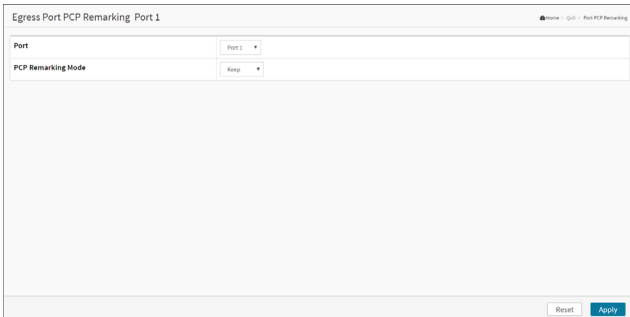

Egress Port PCP Remarking - Port 1

Port: Port 1

PCP Remarking Mode: Keep

Reset Apply

3. Scroll the Port and PCP Remarking Mode and specify the Queue Shaper parameter.
4. Click the Apply to save the setting.

5. If you want to cancel the setting then you need to click the Reset button. It will revert to previously saved values.

Parameter description:

Port:

The logical port for the settings contained in the same row.
Click on the port number in order to configure PCP remarking.

Mode:

Shows the PCP remarking mode for this port.

Keep: Use classified PCP/DEI values.

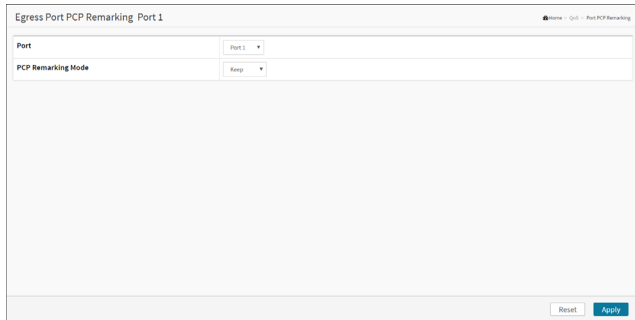

Specific: Use default PCP/DEI values.

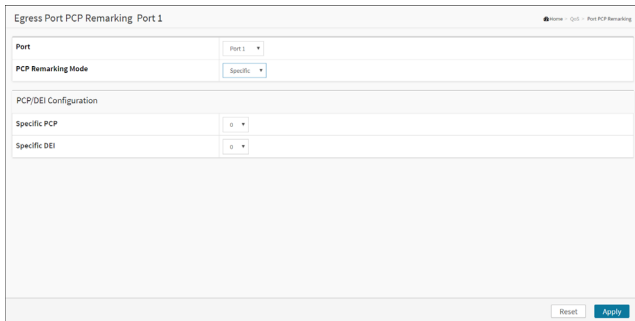

Mapped: Use mapped versions of CoS and DPL.

Egress Port PCP Remarking Port 1 Home | QoS | Port PCP Remarking

Port: Port 1

PCP Remarking Mode: Mapped

(Queue Priority, DP level) to (PCP, DEI) Mapping

Queue Priority	DP level	PCP	DEI
-	-	--	--
0	0	1	0
0	1	1	1
1	0	0	0
1	1	0	1
2	0	2	0
2	1	2	1
3	0	3	0
3	1	3	1
4	0	4	0
4	1	4	1
5	0	5	0
5	1	5	1
6	0	6	0
6	1	6	1
7	0	7	0
7	1	7	1

Reset Apply

PCP/DEI Configuration:

Controls the default PCP and DEI values used when the mode is set to Default.

(QoS class, DP level) to (PCP, DEI) Mapping :

Controls the mapping of the classified (QoS class, DP level) to (PCP, DEI) values when the mode is set to Mapped.

■ Buttons

Apply:

Click to save changes.

Reset:

Click to undo any changes made locally and revert to previously saved values.

DSCP

Port DSCP

The section will teach user to set the QoS Port DSCP configuration that was allowed you to configure the basic QoS Port DSCP Configuration settings for all switch ports. Others the settings relate to the currently selected stack unit, as reflected by the page header.

Port	Ingress		Egress
	Translate	Classify	Rewrite
*	<input type="checkbox"/>	-->	-->
1	<input type="checkbox"/>	Disable	Disable
2	<input type="checkbox"/>	Disable	Disable
3	<input type="checkbox"/>	Disable	Disable
4	<input type="checkbox"/>	Disable	Disable
5	<input type="checkbox"/>	Disable	Disable
6	<input type="checkbox"/>	Disable	Disable
7	<input type="checkbox"/>	Disable	Disable
8	<input type="checkbox"/>	Disable	Disable
9	<input type="checkbox"/>	Disable	Disable

Web Interface

To configure the QoS Port DSCP parameters in the web interface:

1. Click Quality of Service, DSCP and Port DSCP.
2. Evoke to enable or disable the Ingress Translate and Scroll the Classify parameter.
3. Scroll to select Egress Rewrite parameters.
4. Click the apply to save the setting.
5. If you want to cancel the setting then you need to click the Reset button. It will revert to previously saved values.

■ Parameter description:

Port:

The Port column shows the list of ports for which you can configure dscp ingress and egress settings.

Ingress:

In Ingress settings you can change ingress translation and classification settings for individual ports.

There are two configuration parameters available in Ingress:

Translate: To Enable the Ingress Translation click the checkbox

Classify: Classification for a port have 4 different values

Disable: No Ingress DSCP Classification.

DSCP=0: Classify if incoming (or translated if enabled) DSCP is 0.

Selected: Classify only selected DSCP for which classification is enabled as specified in DSCP Translation window for the specific DSCP.

All: Classify all DSCP.

Egress:

Port Egress Rewriting can be one of below parameters

Disable: No Egress rewrite.

Enable: Rewrite enable without remapped.

Remap: DSCP from analyzer is remapped and frame is remarked with remapped DSCP value.

■ Buttons

Apply:

Click to save changes.

Reset:

Click to undo any changes made locally and revert to previously saved values.

DSCP Translation

The section describes the switch allows you to configure the basic QoS DSCP Translation settings for all switches. DSCP translation can be done in Ingress or Egress.

DSCP	Ingress		Classify	Egress	
	Translate			Remap	
*	<<	<input type="checkbox"/>	<<		
0 (BE)	0 (BE)	<input type="checkbox"/>	0 (BE)		
1	1	<input type="checkbox"/>	1		
2	2	<input type="checkbox"/>	2		
3	3	<input type="checkbox"/>	3		
4	4	<input type="checkbox"/>	4		
5	5	<input type="checkbox"/>	5		
6	6	<input type="checkbox"/>	6		
7	7	<input type="checkbox"/>	7		
8 (CS1)	8 (CS1)	<input type="checkbox"/>	8 (CS1)		

Reset Apply

Web Interface

To configure the DSCP Translation parameters in the web interface:

1. Click Quality of Service, DSCP and DSCP Translation.
2. Scroll to set the Ingress Translate and Egress Remap Parameters.
3. Evoke to enable or disable Classify.
4. Click the apply to save the setting.
5. If you want to cancel the setting then you need to click the Reset button. It will revert to previously saved values.

■ Parameter description:

DSCP:

Maximum number of supported DSCP values are 64 and valid DSCP value ranges from 0 to 63.

Ingress:

Ingress side DSCP can be first translated to new DSCP before using the DSCP for QoS class and DPL map.

There are two configuration parameters for DSCP Translation –

Translate: DSCP at Ingress side can be translated to any of (0-63) DSCP values.

Classify: Click to enable Classification at Ingress side.

Egress:

Select the DSCP value from select menu to which you want to remap. DSCP value ranges from 0 to 63.

■ Buttons

Apply:

Click to save changes.

Reset:

Click to undo any changes made locally and revert to previously saved values.

DSCP Classification

The section describes to teach user to configure and allows you to map DSCP value to a QoS Class and DPL value. Others the settings relate to the currently selected stack unit, as reflected by the page header.

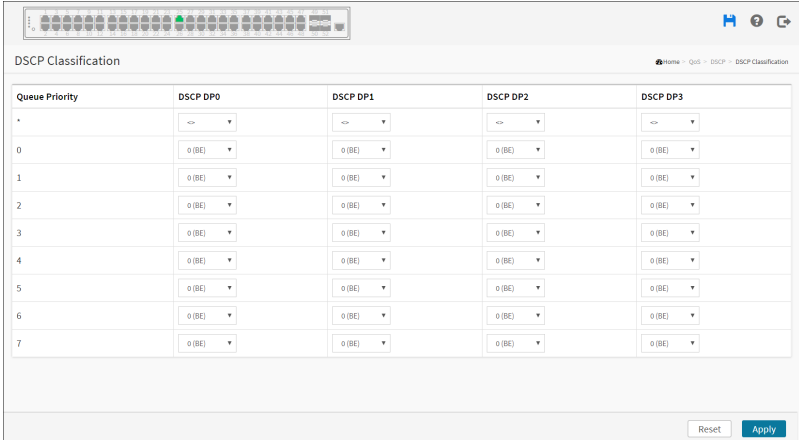

Queue Priority	DSCP DP0	DSCP DP1	DSCP DP2	DSCP DP3
*	<< ▾	<< ▾	<< ▾	<< ▾
0	0 (BE) ▾	0 (BE) ▾	0 (BE) ▾	0 (BE) ▾
1	0 (BE) ▾	0 (BE) ▾	0 (BE) ▾	0 (BE) ▾
2	0 (BE) ▾	0 (BE) ▾	0 (BE) ▾	0 (BE) ▾
3	0 (BE) ▾	0 (BE) ▾	0 (BE) ▾	0 (BE) ▾
4	0 (BE) ▾	0 (BE) ▾	0 (BE) ▾	0 (BE) ▾
5	0 (BE) ▾	0 (BE) ▾	0 (BE) ▾	0 (BE) ▾
6	0 (BE) ▾	0 (BE) ▾	0 (BE) ▾	0 (BE) ▾
7	0 (BE) ▾	0 (BE) ▾	0 (BE) ▾	0 (BE) ▾

Reset Apply

Web Interface

To configure the DSCP Classification parameters in the web interface:

1. Click Quality of Service, DSCP and DSCP Translation.
2. Scroll to set the DSCP Parameters.
3. Click the apply to save the setting.
4. If you want to cancel the setting then you need to click the Reset button. It will revert to previously saved values.

■ **Parameter description:**

Queue Priority:

Actual Class of Service.

DSCP DP0:

Select the classified DSCP value (0-63) for Drop Precedence Level 0.

DSCP DP1:

Select the classified DSCP value (0-63) for Drop Precedence Level 1.

DSCP DP2:

Select the classified DSCP value (0-63) for Drop Precedence Level 2.

DSCP DP3:

Select the classified DSCP value (0-63) for Drop Precedence Level 3.

■ **Buttons**

Apply:

Click to save changes.

Reset:

Click to undo any changes made locally and revert to previously saved values.

DSCP-Based QoS

The section will teach user to configure the DSCP-Based QoS mode that This page allows you to configure the basic QoS DSCP based QoS Ingress Classification settings for all switches.

DSCP	Trust	Queue Priority	DPL
0 (BE)	<input type="checkbox"/>	0	0
1	<input type="checkbox"/>	0	0
2	<input type="checkbox"/>	0	0
3	<input type="checkbox"/>	0	0
4	<input type="checkbox"/>	0	0
5	<input type="checkbox"/>	0	0
6	<input type="checkbox"/>	0	0
7	<input type="checkbox"/>	0	0
8 (CS1)	<input type="checkbox"/>	0	0
9	<input type="checkbox"/>	0	0

Web Interface

To configure the DSCP –Based QoS Ingress Classification parameters in the web interface:

1. Click Quality of Service, DSCP and DSCP-Based QoS.
2. Evoke to enable or disable the DSCP for Trust.
3. Scroll to select Queue Priority and DPL parameters.
4. Click the save to save the setting.If you want to cancel the setting then you need to click the Reset button. It will revert to previously saved values.

■ Parameter description:

DSCP:

Maximum number of support ed DSCP values are 64.

Trust:

Click to check if the DSCP value is trusted.

Queue Priority:

Queue Priority value can be any between 0 and 7. 7 is the highest.

DPL:

Drop Precedence Level (0-3)

■ **Buttons**

Apply:

Click to save changes.

Reset:

Click to undo any changes made locally and revert to previously saved values.

QoS Control List

Configuration

The section shows the QoS Control List (QCL), which is made up of the QCEs. Each row describes a QCE that is defined. The maximum number of QCEs is 256 on each switch. Click on the lowest plus sign to add a new QCE to the list.

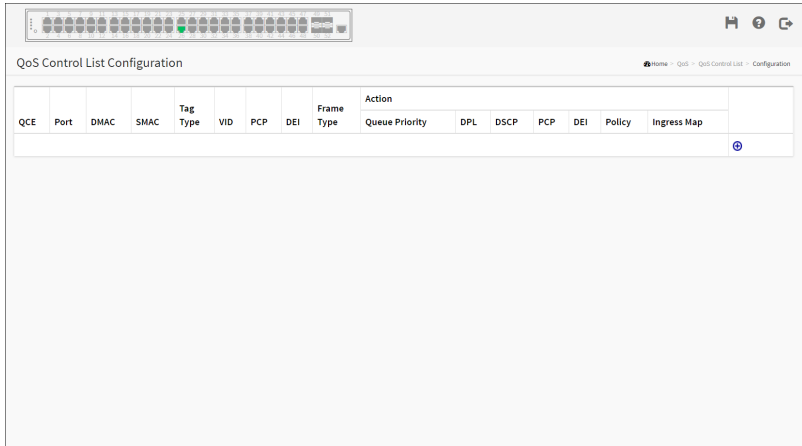

Web Interface

To configure the QoS Control List parameters in the web interface:

1. Click Quality of Service, QoS Control List and Configuration.
2. Click  to add a new QoS Control List.

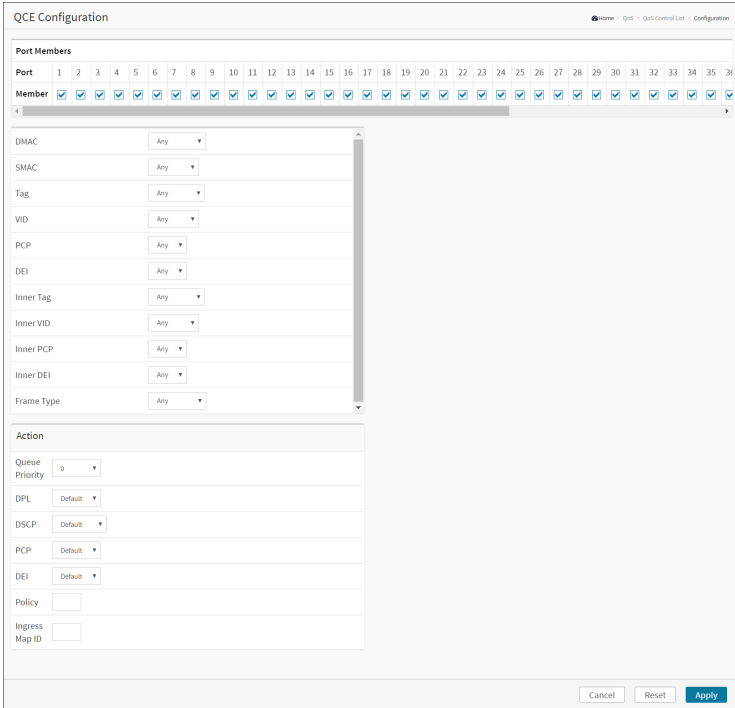

3. Scroll all parameters and evoke the Port Member to join the QCE rules.
4. Click the apply to save the setting.
5. If you want to cancel the setting then you need to click the Reset button. It will revert to previously saved values.

■ Parameter description:

QCE:

Indicates the index of QCE.

Port:

Indicates the list of ports configured with the QCE.

DMAC:

Indicates the destination MAC address. Possible values are:

Any: Match any DMAC.

Unicast: Match unicast DMAC.

Multicast: Match multicast DMAC.

Broadcast: Match broadcast DMAC.

<MAC>: Match specific DMAC.

The default value is 'Any'.

SMAC:

Match specific source MAC address or 'Any'.

If a port is configured to match on DMAC/DIP, this field indicates the DMAC.

Tag Type:

Indicates tag type. Possible values are:

Any: Match tagged and untagged frames.

Untagged: Match untagged frames.

Tagged: Match tagged frames.

C-Tagged: Match C-tagged frames.

S-Tagged: Match S-tagged frames.

The default value is 'Any'.

VID:

Indicates (VLAN ID), either a specific VID or range of VIDs. VID can be in the range 1-4095 or 'Any'

PCP:

Priority Code Point: Valid values of PCP are specific (0, 1, 2, 3, 4, 5, 6, 7) or range(0-1, 2-3, 4-5, 6-7, 0-3, 4-7) or 'Any'.

DEI:

Drop Eligible Indicator: Valid value of DEI are 0, 1 or 'Any'.

Frame Type:

Indicates the type of frame to look for incoming frames. Possible frame types are:

Any: The QCE will match all frame type.

Ethernet: Only Ethernet frames (with Ether Type 0x600-0xFFFF) are allowed.

LLC: Only (LLC) frames are allowed.

SNAP: Only (SNAP) frames are allowed

IPv4: The QCE will match only IPV4 frames.

IPv6: The QCE will match only IPV6 frames.

Action:

Indicates the classification action taken on ingress frame if parameters configured are matched with the frame's content.

Possible actions are:

CoS: Classify Class of Service.

DPL: Classify Drop Precedence Level.

DSCP: Classify DSCP value.

PCP: Classify PCP value.

DEI: Classify DEI value.

Policy: Classify ACL Policy number.

Modification Buttons :

You can modify each QCE (QoS Control Entry) in the table using the following buttons:



: Inserts a new QCE before the current row.



: Edits the QCE.



: Moves the QCE up the list.



: Moves the QCE down the list.



: Deletes the QCE.



: The lowest plus sign adds a new entry at the bottom of the QCE listings.

Port Members:

Check the checkbox button to include the port in the QCL entry. By default all ports are included.

Key Parameters:

Key configuration is described as below:

DMAC Destination MAC address: Possible values are 'Unicast', 'Multicast', 'Broadcast', 'Specific' (xx-xx-xx-xx-xx-xx) or 'Any'.

SMAC Source MAC address: xx-xx-xx-xx-xx-xx or 'Any'.

Tag Value of Tag field can be 'Untagged', 'Tagged', 'C-Tagged', 'S-Tagged' or 'Any'.

VID Valid value of VLAN ID can be any value in the range 1-4095 or 'Any'; user can enter either a specific value or a range of VIDs.

PCP Valid value PCP are specific (0, 1, 2, 3, 4, 5, 6, 7) or range (0-1, 2-3, 4-5, 6-7, 0-3, 4-7) or 'Any'.

DEI Valid value of DEI can be '0', '1' or 'Any'.

Inner Tag Value of Inner Tag field can be 'Untagged', 'Tagged', 'C-Tagged', 'S-Tagged' or 'Any'.

Inner VID Valid value of Inner VLAN ID can be any value in the range 1-4095 or 'Any'; user can enter either a specific value or a range of VIDs.

Inner PCP Valid value of Inner PCP are specific (0, 1, 2, 3, 4, 5, 6, 7) or range (0-1, 2-3, 4-5, 6-7, 0-3, 4-7) or 'Any'.

Inner DEI Valid value of Inner DEI can be '0', '1' or 'Any'.

Frame Type Frame Type can have any of the following values:

Any

EtherType

LLC

SNAP

IPv4

IPv6

Note: All frame types are explained below.

Any:

Allow all types of frames.

EtherType:

Ether Type Valid Ether Type can be 0x600-0xFFFF excluding 0x800(IPv4) and 0x86DD(IPv6) or 'Any'.

LLC:

DSAP Address Valid DSAP(Destination Service Access Point) can vary from 0x00 to 0xFF or 'Any'.

SSAP Address Valid SSAP(Source Service Access Point) can vary from 0x00 to 0xFF or 'Any'.

Control Valid Control field can vary from 0x00 to 0xFF or 'Any'.

SNAP:

PID Valid PID(a.k.a Ether Type) can be 0x0000-0xFFFF or 'Any'.

IPv4:

Protocol IP protocol number: (0-255, 'TCP' or 'UDP') or 'Any'.

Source IP Specific Source IP address in value/mask format or 'Any'. IP and Mask are in the format x.y.z.w where x, y, z, and w are decimal numbers between 0 and 255. When Mask is converted to a 32-bit binary string and read from left to right, all bits following the first zero must also be zero.

Destination IP Specific Destination IP address in value/mask format or 'Any'.

IP Fragment IPv4 frame fragmented option: 'Yes', 'No' or 'Any'.

DSCP Diffserv Code Point value (DSCP): It can be a specific value, range of values or 'Any'. DSCP values are in the range 0-63 including BE, CS1-CS7, EF or AF11-AF43.

Sport Source TCP/UDP port:(0-65535) or 'Any', specific or port range applicable for IP protocol UDP/TCP.

Dport Destination TCP/UDP port:(0-65535) or 'Any', specific or port range applicable for IP protocol UDP/TCP.

IPv6:

Protocol IP protocol number: (0-255, 'TCP' or 'UDP') or 'Any'.

Source IP 32 LS bits of IPv6 source address in value/mask format or 'Any'.

Destination IP Specific Destination IP address in value/mask format or 'Any'.

DSCP Diffserv Code Point value (DSCP): It can be a specific value, range of values or 'Any'. DSCP values are in the range 0-63 including BE, CS1-CS7, EF or AF11-AF43.

Sport Source TCP/UDP port:(0-65535) or 'Any', specific or port range applicable for IP protocol UDP/TCP.

Dport Destination TCP/UDP port:(0-65535) or 'Any', specific or port range applicable for IP protocol UDP/TCP.

Action Parameters:

CoS Class of Service: (0-7) or 'Default'.

DPL Drop Precedence Level: (0-3) or 'Default'.

DSCP DSCP: (0-63, BE, CS1-CS7, EF or AF11-AF43) or 'Default'.

PCP PCP: (0-7) or 'Default'. Note: PCP and DEI cannot be set individually.

DEI DEI: (0-1) or 'Default'.

Policy ACL Policy number: (0-127) or 'Default' (empty field).

'Default' means that the default classified value is not modified by this QCE.

■ Buttons

Apply:

Click to save changes.

Reset:

Click to undo any changes made locally and revert to previously saved values.

Cancel:

Return to the previous page without saving the configuration change.

Status

The section will let you know how to configure and shows the QCL status by different QCL users. Each row describes the QCE that is defined. It is a conflict if a specific QCE is not applied to the hardware due to hardware limitations. The maximum number of QCEs is 256 on each switch.

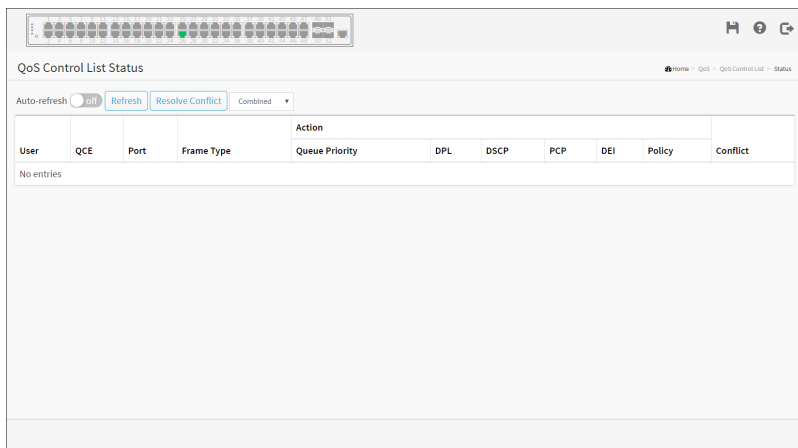

Web Interface

To display the QoS Control List Status in the web interface:

1. Click Quality of Service, QoS Control List and Status.
2. If you want to auto-refresh the information then you need to evoke the “Auto-refresh”.
3. Scroll to select the combined, static, Voice VLAN and conflict.
4. To click the “Refresh” to refresh an entry of the MVR Statistics Information.

■ Parameter description:

User:

Indicates the QCL user.

QCE:

Indicates the index of QCE.

Port:

Indicates the list of ports configured with the QCE.

Frame Type:

Indicates the type of frame. Possible values are:

Any: Match any frame type.

Ethernet: Match EtherType frames.

LLC: Match (LLC) frames.

SNAP: Match (SNAP) frames.

IPv4: Match IPv4 frames.

IPv6: Match IPv6 frames.

Action:

Indicates the classification action taken on ingress frame if parameters configured are matched with the frame's content.

Possible actions are:

CoS: Classify Class of Service.

DPL: Classify Drop Precedence Level.

DSCP: Classify DSCP value.

PCP: Classify PCP value.

DEI: Classify DEI value.

Policy: Classify ACL Policy number.

Ingress Map: Classify Ingress Map ID.

Conflict:

Displays Conflict status of QCL entries. It may happen that resources required to add a QCE may not available, in that case it shows conflict status as 'Yes', otherwise it is always 'No'. Please note that conflict can be resolved by releasing the H/W resources required to add QCL entry on pressing 'Resolve Conflict' button.

■ Buttons**Auto-refresh:**

Check this box to refresh the page automatically. Automatic refresh occurs every 3 seconds.

Refresh:

Click to refresh the page immediately.

Combined:

Select the QCL status from this drop down list.

Resolve Conflict:

Click to release the resources required to add QCL entry, in case the conflict status for any QCL entry is 'yes'.

QoS Statistics

This page provides statistics for the different queues for all switch ports.

The screenshot shows a web interface titled "Queuing Counters" with a navigation bar at the top. Below the title, there is an "Auto-refresh" toggle set to "off", and "Refresh" and "Clear" buttons. The main content is a table with 13 rows (ports 1-13) and 16 columns. The columns are grouped by queue (Q0-Q7), with each queue having an Rx and Tx column. All data points in the table are 0.

Port	Q0		Q1		Q2		Q3		Q4		Q5		Q6		Q7	
	Rx	Tx	Rx	Tx	Rx	Tx	Rx	Tx	Rx	Tx	Rx	Tx	Rx	Tx	Rx	Tx
1	0	0	0	0	0	0	0	0	0	0	0	0	0	0	0	0
2	0	0	0	0	0	0	0	0	0	0	0	0	0	0	0	0
3	0	0	0	0	0	0	0	0	0	0	0	0	0	0	0	0
4	0	0	0	0	0	0	0	0	0	0	0	0	0	0	0	0
5	0	0	0	0	0	0	0	0	0	0	0	0	0	0	0	0
6	0	0	0	0	0	0	0	0	0	0	0	0	0	0	0	0
7	0	0	0	0	0	0	0	0	0	0	0	0	0	0	0	0
8	0	0	0	0	0	0	0	0	0	0	0	0	0	0	0	0
9	0	0	0	0	0	0	0	0	0	0	0	0	0	0	0	0
10	0	0	0	0	0	0	0	0	0	0	0	0	0	0	0	0
11	0	0	0	0	0	0	0	0	0	0	0	0	0	0	0	0
12	0	0	0	0	0	0	0	0	0	0	0	0	0	0	0	0
13	0	0	0	0	0	0	0	0	0	0	0	0	0	0	0	0

Web Interface

To Display the Queuing Counters in the web interface:

1. Click Quality of Service and QoS Statistics.
2. If you want to auto-refresh the information then you need to evoke the “Auto-refresh”.
3. Click “Refresh” to refresh the Queuing Counters or clear all information when you click “Clear”.

■ Parameter description:

Port:

The logical port for the settings contained in the same row.

Qn:

Qn is the Queue number, There are 8 QoS queues per port. Q0 is the lowest priority queue.

Rx/Tx:

The number of received and transmitted packets per queue.

■ Buttons



Auto-refresh:

Check this box to refresh the page automatically. Automatic refresh occurs every 3 seconds.

Refresh:

Click to refresh the page.

Clear:

Click to clear the page.

WRED

This page allows you to configure the Random Early Detection (RED) settings. Through different RED configuration for the queues it is possible to obtain Weighted Random Early Detection (WRED) operation between queues. The settings are global for all ports in the switch.

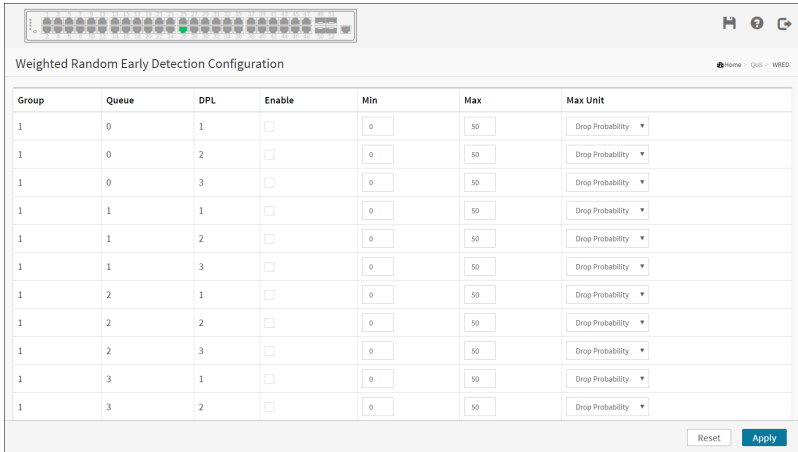

Group	Queue	DPL	Enable	Min	Max	Max Unit
1	0	1	<input type="checkbox"/>	0	50	Drop Probability ▼
1	0	2	<input type="checkbox"/>	0	50	Drop Probability ▼
1	0	3	<input type="checkbox"/>	0	50	Drop Probability ▼
1	1	1	<input type="checkbox"/>	0	50	Drop Probability ▼
1	1	2	<input type="checkbox"/>	0	50	Drop Probability ▼
1	1	3	<input type="checkbox"/>	0	50	Drop Probability ▼
1	2	1	<input type="checkbox"/>	0	50	Drop Probability ▼
1	2	2	<input type="checkbox"/>	0	50	Drop Probability ▼
1	2	3	<input type="checkbox"/>	0	50	Drop Probability ▼
1	3	1	<input type="checkbox"/>	0	50	Drop Probability ▼
1	3	2	<input type="checkbox"/>	0	50	Drop Probability ▼

Web Interface

To configure and display the Random Early Detection in the web interface:

1. Click Quality of Service and WRED.
2. Scroll all parameters and evoke the Weighted Random Early Detection Configuration.
3. Click the apply to save the setting.
4. If you want to cancel the setting then you need to click the Reset button. It will revert to previously saved values.

■ Parameter description:

Port:

The logical port for the settings contained in the same row.

Group:

The WRED group number for which the configuration below applies.

Queue:

The queue number (CoS) for which the configuration below applies.

DPL:

The Drop Precedence Level for which the configuration below applies.

Enable:

Controls whether RED is enabled for this entry.

Min:

Controls the lower RED fill level threshold. If the queue filling level is below this threshold, the drop probability is zero. This value is restricted to 0-100%.

Max:

Controls the upper RED drop probability or fill level threshold for frames marked with Drop Precedence Level > 0 (yellow frames). This value is restricted to 1-100%.

Max Unit:

Selects the unit for Max. PossiXBFe values are:

Drop Probability: Max controls the drop probability just below 100% fill level.

Fill Level: Max controls the fill level where drop probability reaches 100%.

RED Drop Probability Function

The following illustration shows the drop probability versus fill level function with associated parameters.

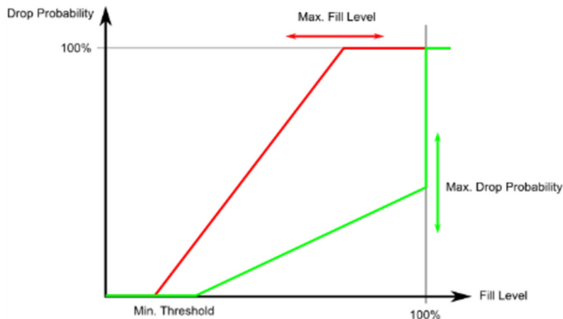

Min is the fill level where the queue randomly start dropping frames marked with Drop Precedence Level > 0 (yellow frames).

If Max Unit is 'Drop Probability' (the green line), Max controls the drop probability when the fill level is just below 100%.

If Max Unit is 'Fill Level' (the red line), Max controls the fill level where drop probability reaches 100%. This configuration makes it possiXBFe to reserve a

portion of the queue exclusively for frames marked with Drop Precedence Level 0 (green frames). The reserved portion is calculated as $(100 - \text{Max}) \%$. Frames marked with Drop Precedence Level 0 (green frames) are never dropped.

The drop probability for frames increases linearly from zero (at Min average queue filling level) to Max Drop Probability or Fill Level.

■ **Buttons**

Apply:

Click to save changes.

Refresh:

Click to refresh the page.

Chapter 8

Spanning Tree

Overview

The Spanning Tree Protocol (STP) can be used to detect and disable network loops, and to provide backup links between switches, bridges or routers. This allows the switch to interact with other bridging devices (that is, an STP-compliant switch, bridge or router) in your network to ensure that only one route exists between any two stations on the network, and provide backup links which automatically take over when a primary link goes down.

STP - STP uses a distributed algorithm to select a bridging device (STP-compliant switch, bridge or router) that serves as the root of the spanning tree network. It selects a root port on each bridging device (except for the root device) which incurs the lowest path cost when forwarding a packet from that device to the root device. Then it selects a designated bridging device from each LAN which incurs the lowest path cost when forwarding a packet from that LAN to the root device. All ports connected to designated bridging devices are assigned as designated ports. After determining the lowest cost spanning tree, it enables all root ports and designated ports, and disables all other ports. Network packets are therefore only forwarded between root ports and designated ports, eliminating any possible network loops.

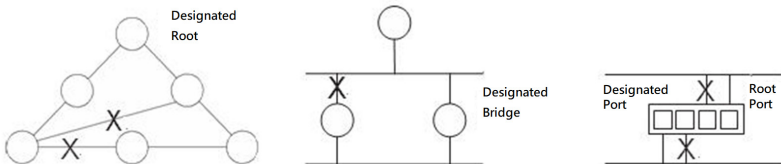

Once a stable network topology has been established, all bridges listen for Hello BPDUs (Bridge Protocol Data Units) transmitted from the Root Bridge. If a bridge does not get a Hello BPDU after a predefined interval (Maximum Age), the bridge assumes that the link to the Root Bridge is down. This bridge will then initiate negotiations with other bridges to reconfigure the network to reestablish a valid network topology.

The menu is shown below:

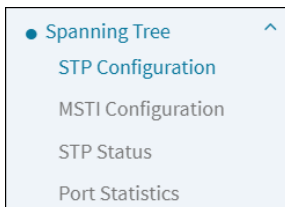

STP Configuration

The section describes that you can select enable spanning tree protocol or not, and you can select what protocol version you want.

STP Bridge Configuration

Basic Settings

Protocol Version	MSTP
Bridge Priority	32768
Hello Time	2
Forward Delay	15
Max Age	20
Maximum Hop Count	20
Transmit Hold Count	6

Advanced Settings

Edge Port BPDU Filtering	<input type="checkbox"/>
Edge Port BPDU Guard	<input type="checkbox"/>
Port Error Recovery	<input type="checkbox"/>
Port Error Recovery Timeout	

Root Guard

Port	Root Guard
-	<input type="checkbox"/>
1	<input type="checkbox"/>
2	<input type="checkbox"/>
3	<input type="checkbox"/>
4	<input type="checkbox"/>

Reset Apply

Web Interface

To configure the Spanning Tree Protocol version in the web interface:

1. Click Spanning Tree and STP Configuration.
2. Scroll to select the parameters and write down available value of parameters in blank field in Basic Settings.
3. Evoke to enable or disable the parameters and write down available value of parameters in blank field in Advanced settings.
4. Click the apply to save the setting.
5. If you want to cancel the setting then you need to click the Reset button. It will revert to previously saved values.

■ Parameter description:**Basic Settings**

Protocol Version:

The MSTP / RSTP / STP protocol version setting. Valid values are STP, RSTP and MSTP.

Bridge Priority:

Controls the bridge priority. Lower numeric values have better priority. The bridge priority plus the MSTI instance number, concatenated with the 6-byte MAC address of the switch forms a Bridge Identifier. For MSTP operation, this is the priority of the CIST. Otherwise, this is the priority of the STP/RSTP Bridge.

Hello Time:

The interval between sending STP BPDU's. Valid values are in the range 1 to 10 seconds, default is 2 seconds.

Note: Changing this parameter from the default value is not recommended, and may have adverse effects on your network.

Forward Delay:

The delay used by STP Bridges to transit Root and Designated Ports to Forwarding (used in STP compatible mode). Valid values are in the range 4 to 30 seconds.

Max Age:

The maximum age of the information transmitted by the Bridge when it is the Root Bridge. Valid values are in the range 6 to 40 seconds, and MaxAge must be $\leq (\text{FwdDelay}-1)*2$.

Maximum Hop Count:

This defines the initial value of remaining Hops for MSTI information generated at the boundary of an MSTI region. It defines how many bridges a root bridge can distribute its BPDU information to. Valid values are in the range 6 to 40 hops.

Transmit Hold Count:

The number of BPDU's a bridge port can send per second. When exceeded, transmission of the next BPDU will be delayed. Valid values are in the range 1 to 10 BPDU's per second.

Advanced Settings

Edge Port BPDU Filtering:

Control whether a port explicitly configured as Edge will transmit and receive BPDUs.

Edge Port BPDU Guard:

Control whether a port explicitly configured as Edge will disable itself upon reception of a BPDU. The port will enter the error-disabled state, and will be removed from the active topology.

Port Error Recovery:

Control whether a port in the error-disabled state automatically will be enabled after a certain time. If recovery is not enabled, ports have to be disabled and re-enabled for normal STP operation. The condition is also cleared by a system reboot.

Port Error Recovery Timeout:

The time to pass before a port in the error-disabled state can be enabled. Valid values are between 30 and 86400 seconds (24 hours).

■ Buttons

Apply:

Click to save changes.

Reset:

Click to undo any changes made locally and revert to previously saved values.

MSTI Configuration

When you implement a Spanning Tree protocol on the switch that the bridge instance. The CIST is not available for explicit mapping, as it will receive the VLANs not explicitly mapped. Due to the reason that you need to set the list of VLANs mapped to the MSTI. The VLANs must be separated with comma and/or space. A VLAN can only be mapped to one MSTI. An unused MSTI should just be left empty. (I.e. not having any VLANs mapped to it.)

This section describes it allows the user to inspect the current STP MSTI bridge instance priority configurations, and possibly change them as well.

Instance	VLANs Mapped	MSTI Priority	MSTI Port
CIST	Unmapped VLANs are mapped to the CIST	32768	Edit
MSTI1	Example: 2,3,5,11,13,20-40	32768	Edit
MSTI2	Example: 2,3,5,11,13,20-40	32768	Edit
MSTI3	Example: 2,3,5,11,13,20-40	32768	Edit
MSTI4	Example: 2,3,5,11,13,20-40	32768	Edit

Web Interface

To configure the Spanning Tree MSTI in the web interface:

1. Click Spanning Tree and MSTI Configuration.
2. Specify the configuration identification parameters in the field. Specify the VLANs Mapped blank field.
3. Click the Apply to save the setting.
4. If you want to cancel the setting then you need to click the Reset button. It will revert to previously saved values.
5. Click Edit to configure the STP CIST Port Configuration.

■ Parameter description:**Configuration Identification**

Configuration Name:

The name identifying the VLAN to MSTI mapping. Bridges must share the name and revision (see below), as well as the VLAN-to-MSTI mapping configuration in order to share spanning trees for MSTI's (Intra-region). The name is at most 32 characters.

Configuration Revision:

The revision of the MSTI configuration named above. This must be an integer between 0 and 65535.

MSTI Mapping

Instance:

The bridge instance. The CIST is not available for explicit mapping, as it will receive the VLANs not explicitly mapped.

VLANs Mapped:

The list of VLANs mapped to the MSTI. The VLANs can be given as a single (xx, xx being between 1 and 4094) VLAN, or a range (xx-yy), each of which must be separated with comma and/or space. A VLAN can only be mapped to one MSTI. An unused MSTI should just be left empty. (I.e. not having any VLANs mapped to it.) Example: 2,5,20-40.

MSTI Priority:

Controls the bridge priority. Lower numeric values have better priority. The bridge priority plus the MSTI instance number, concatenated with the 6-byte MAC address of the switch forms a Bridge Identifier.

■ Buttons

Apply:

Click to save changes.

Reset:

Click to undo any changes made locally and revert to previously saved values.

MSTI Port:

Click to configure the STP CIST Port Configuration.

STP CIST Port Configuration Home > Spanning Tree > MSTI Configuration

CIST Aggregated Port Configuration

Port	STP Enabled	Path Cost	Priority	Admin Edge	Auto Edge	Restricted			Point-to-point
						Role	TCN	BPDU Guard	
-	<input checked="" type="checkbox"/>	Auto	128	Non-Edge	<input checked="" type="checkbox"/>	<input type="checkbox"/>	<input type="checkbox"/>	<input type="checkbox"/>	Forced True

CIST Normal Port Configuration

Port	STP Enabled	Path Cost	Priority	Admin Edge	Auto Edge	Restricted			Point-to-point
						Role	TCN	BPDU Guard	
*	<input checked="" type="checkbox"/>	<>	<>	<>	<input checked="" type="checkbox"/>	<input type="checkbox"/>	<input type="checkbox"/>	<input type="checkbox"/>	<>
1	<input checked="" type="checkbox"/>	Auto	128	Non-Edge	<input checked="" type="checkbox"/>	<input type="checkbox"/>	<input type="checkbox"/>	<input type="checkbox"/>	Auto
2	<input checked="" type="checkbox"/>	Auto	128	Non-Edge	<input checked="" type="checkbox"/>	<input type="checkbox"/>	<input type="checkbox"/>	<input type="checkbox"/>	Auto
3	<input checked="" type="checkbox"/>	Auto	128	Non-Edge	<input checked="" type="checkbox"/>	<input type="checkbox"/>	<input type="checkbox"/>	<input type="checkbox"/>	Auto
4	<input checked="" type="checkbox"/>	Auto	128	Non-Edge	<input checked="" type="checkbox"/>	<input type="checkbox"/>	<input type="checkbox"/>	<input type="checkbox"/>	Auto

[Back to MSTI Configuration](#)

Parameter description:

Port:

The switch port number of the logical STP port.

STP Enabled:

Controls whether STP is enabled on this switch port. This field will be read only if Voice VLAN feature is enabled. The Voice VLAN port mode will be read only if this field be Enabled.

Path Cost:

Controls the path cost incurred by the port. The Auto setting will set the path cost as appropriate by the physical link speed, using the 802.1D recommended values. Using the Specific setting, a user-defined value can be entered. The path cost is used when establishing the active topology of the network. Lower path cost ports are chosen as forwarding ports in favor of higher path cost ports. Valid values are in the range 1 to 20000000.

Priority:

Controls the port priority. This can be used to control priority of ports having identical port cost. (See above).

AdminEdge:

Controls whether the operEdge flag should start as set or cleared. (The initial operEdge state when a port is initialized).

AutoEdge:

Controls whether the bridge should enable automatic edge detection on the bridge port. This allows operEdge to be derived from whether BPDU's are received on the port or not.

Restricted Role:

If enabled, causes the port not to be selected as Root Port for the CIST or any MSTI, even if it has the best spanning tree priority vector. Such a port will be selected as an Alternate Port after the Root Port has been selected. If set, it can cause lack of spanning tree connectivity. It can be set by a network administrator to prevent bridges external to a core region of the network influence the spanning tree active topology, possibly because those bridges are not under the full control of the administrator. This feature is also known as Root Guard.

Restricted TCN:

If enabled, causes the port not to propagate received topology change notifications and topology changes to other ports. If set it can cause temporary loss of connectivity after changes in a spanning tree's active topology as a result of persistently incorrect learned station location information. It is set by a network administrator to prevent bridges external to a core region of the network, causing address flushing in that region, possibly because those bridges are not under the full control of the administrator or the physical link state of the attached LANs transits frequently.

BPDU Guard:

If enabled, causes the port to disable itself upon receiving valid BPDU's. Contrary to the similar bridge setting, the port Edge status does not affect this setting. A port entering error-disabled state due to this setting is subject to the bridge Port Error Recovery setting as well.

Point to Point

Controls whether the port connects to a point-to-point LAN rather than to a shared medium. This can be automatically determined, or forced either true or false. Transition to the forwarding state is faster for point-to-point LANs than for shared media.

■ Buttons

Apply:

Click to save changes.

Reset:

Click to undo any changes made locally and revert to previously saved values.

STP Status

This page provides a status overview of all STP bridge instances.

The displayed table contains a row for each STP bridge instance, where the column displays the following information:

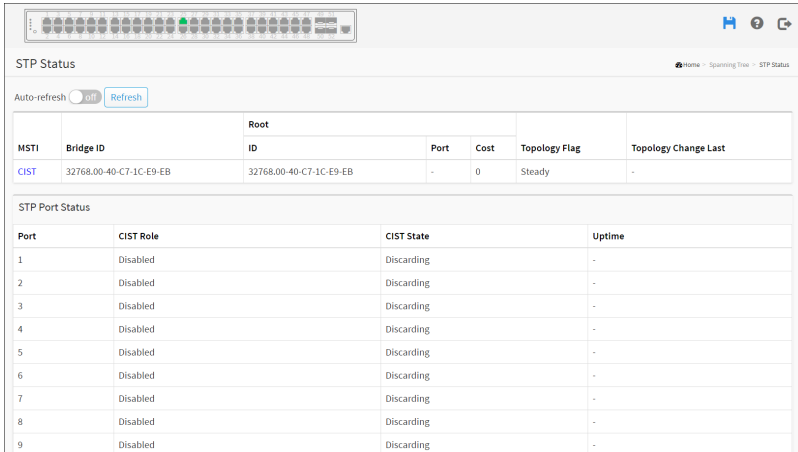

The screenshot shows the 'STP Status' web interface. At the top, there is a navigation bar with 'Home', 'Spanning Tree', and 'STP Status'. Below the navigation bar, there is a section for 'Auto-refresh' with a toggle set to 'off' and a 'Refresh' button. The main content area contains two tables.

MSTI	Bridge ID	Root			Topology Flag	Topology Change Last
		ID	Port	Cost		
CIST	32768.00-40-C7-1C-E9-EB	32768.00-40-C7-1C-E9-EB	-	0	Steady	-

Port	CIST Role	CIST State	Uptime
1	Disabled	Discarding	-
2	Disabled	Discarding	-
3	Disabled	Discarding	-
4	Disabled	Discarding	-
5	Disabled	Discarding	-
6	Disabled	Discarding	-
7	Disabled	Discarding	-
8	Disabled	Discarding	-
9	Disabled	Discarding	-

Web Interface

To display the STP Bridges status in the web interface:

1. Click Spanning Tree and STP Status.
2. If you want to auto-refresh the information then you need to evoke the “Auto-refresh”.
3. Click “Refresh” to refresh the STP Bridges.
4. Click “CIST” to next page “STP Detailed Bridge Status”.

■ Parameter description:

MSTI:

The Bridge Instance. This is also a link to the STP Detailed Bridge Status.

Bridge ID:

The Bridge ID of this Bridge instance.

Root ID:

The Bridge ID of the currently elected root bridge.

Root Port:

The switch port currently assigned the root port role.

Root Cost:

Root Path Cost. For the Root Bridge it is zero. For all other Bridges, it is the sum of the Port Path Costs on the least cost path to the Root Bridge.

Topology Flag:

The current state of the Topology Change Flag of this Bridge instance.

Topology Change Last:

The time since last Topology Change occurred.

STP Port Status

Port:

The switch port number of the logical STP port.

CIST Role:

The current STP port role of the CIST port. The port role can be one of the following values: AlternatePort, Backup Port, RootPort, DesignatedPort Disabled.

CIST State:

The current STP port state of the CIST port. The port state can be one of the following values: Blocking Learning Forwarding.

Uptime:

The time since the bridge port was last initialized.

■ Buttons



Auto-refresh:

Check this box to refresh the page automatically. Automatic refresh occurs every 3 seconds.

Refresh:

Click to refresh the page.

CIST:

Click to next page “STP Detailed Bridge Status”.

STP Detailed Bridge Status							
Auto-refresh <input type="checkbox"/> Refresh							
STP Bridge Status							
Bridge Instance	CIST						
Bridge ID	32768.00-40-C7-1C-E9-EB						
Root ID	32768.00-40-C7-1C-E9-EB						
Root Cost	0						
Root Port	-						
Regional Root	32768.00-40-C7-1C-E9-EB						
Internal Root Cost	0						
Topology Flag	Steady						
Topology Change Count	0						
Topology Change Last	-						
CIST Ports & Aggregations State							
Port	Port ID	Role	State	Path Cost	Edge	Point-to-Point	Uptime
26	128:01a	DesignatedPort	Forwarding	20000	Yes	Yes	0d 07:57:19

■ Parameter description:

STP Bridge Status

Bridge Instance

The Bridge instance - CIST, MST1, ...

Bridge ID

The Bridge ID of this Bridge instance.

Root ID

The Bridge ID of the currently elected root bridge.

Root Cost

Root Path Cost. For the Root Bridge this is zero. For all other Bridges, it is the sum of the Port Path Costs on the least cost path to the Root Bridge.

Root Port

The switch port currently assigned the root port role.

Regional Root

The Bridge ID of the currently elected regional root bridge, inside the MSTP region of this bridge. (For the CIST instance only).

Internal Root Cost

The Regional Root Path Cost. For the Regional Root Bridge this is zero. For all other CIST instances in the same MSTP region, it is the sum of the Internal Port Path Costs on the least cost path to the Internal Root Bridge. (For the CIST instance only).

Topology Flag

The current state of the Topology Change Flag of this Bridge instance.

Topology Change Count

The number of times where the topology change flag has been set (during a one-second interval).

Topology Change Last

The time passed since the Topology Flag was last set.

CIST Ports & Aggregations State

Port

The switch port number of the logical STP port.

Port ID

The port id as used by the STP protocol. This is the priority part and the logical port index of the bridge port.

Role

The current STP port role. The port role can be one of the following values: AlternatePort BackupPort RootPortDesignatedPort.

State

The current STP port state. The port state can be one of the following values: Discarding Learning Forwarding.

Path Cost

The current STP port path cost. This will either be a value computed from the Auto setting, or any explicitly configured value.

Edge

The current STP port (operational) Edge Flag. An Edge Port is a switch port to which no Bridges are attached. The flag may be automatically computed or explicitly configured. Each Edge Port transits directly to the Forwarding Port State, since there is no possibility of it participating in a loop.

Point-to-Point

The current STP port point-to-point flag. A point-to-point port connects to a non-shared LAN media. The flag may be automatically computed or explicitly configured. The point-to-point properties of a port affect how fast it can transit to STP state.

Uptime

The time since the bridge port was last initialized.

■ Buttons



Auto-refresh:

Check this box to refresh the page automatically. Automatic refresh occurs every 3 seconds.

Refresh:

Click to refresh the page.

Port Statistics

This page displays the STP port statistics counters of bridge ports in the switch.

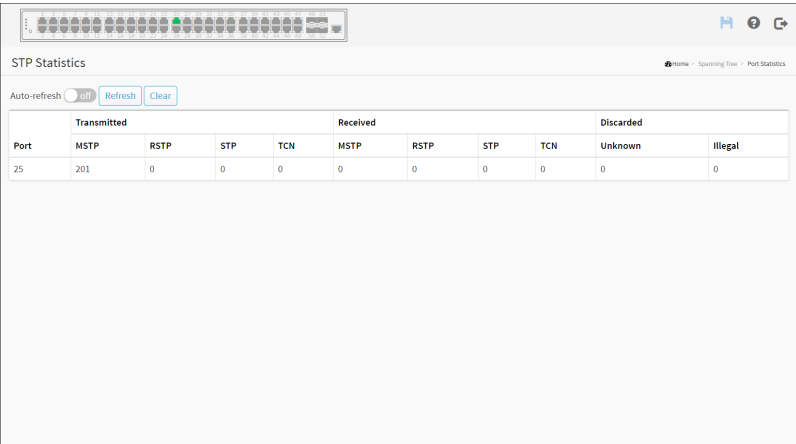

The screenshot shows the 'STP Statistics' web interface. At the top, there is a navigation bar with 'Home', 'Spanning Tree', and 'Port Statistics'. Below the navigation bar, there is a section for 'Auto-refresh' with a toggle set to 'off' and 'Refresh' and 'Clear' buttons. The main content is a table with the following structure:

Port	Transmitted				Received				Discarded	
	MSTP	RSTP	STP	TCN	MSTP	RSTP	STP	TCN	Unknown	Illegal
25	201	0	0	0	0	0	0	0	0	0

Web Interface

To display the STP Port Statistic in the web interface:

1. Click Spanning Tree and Port Statistics.
2. If you want to auto-refresh the information then you need to evoke the “Auto-refresh”.
3. Click “Refresh” to refresh the STP Bridges.

■ Parameter description:

Port:

The switch port number of the logical STP port.

MSTP:

The number of MSTP Configuration BPDU's received/transmitted on the port.

RSTP:

The number of RSTP Configuration BPDU's received/transmitted on the port.

STP:

The number of legacy STP Configuration BPDU's received/transmitted on the port.

TCN:

The number of (legacy) Topology Change Notification BPDU's received/transmitted on the port.

Discarded Unknown:

The number of unknown Spanning Tree BPDU's received (and discarded) on the port.

Discarded Illegal:

The number of illegal Spanning Tree BPDU's received (and discarded) on the port.

■ **Buttons**

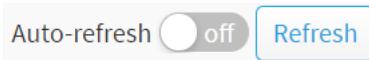

Auto-refresh:

Check this box to refresh the page automatically. Automatic refresh occurs every 3 seconds.

Refresh:

Click to refresh the page.

Chapter 9

MAC Address Tables

Overview

Switching of frames is based upon the DMAC address contained in the frame. The switch builds up a table that maps MAC addresses to switch ports for knowing which ports the frames should go to (based upon the DMAC address in the frame). This table contains both static and dynamic entries. The static entries are configured by the network administrator if the administrator wants to do a fixed mapping between the DMAC address and switch ports.

The frames also contain a MAC address (SMAC address), which shows the MAC address of the equipment sending the frame. The SMAC address is used by the switch to automatically update the MAC table with these dynamic MAC addresses. Dynamic entries are removed from the MAC table if no frame with the corresponding SMAC address have been seen after a configurable age time.

The menu is shown below:

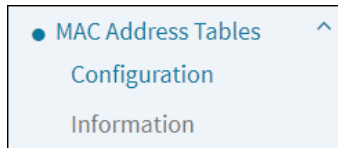

Configuration

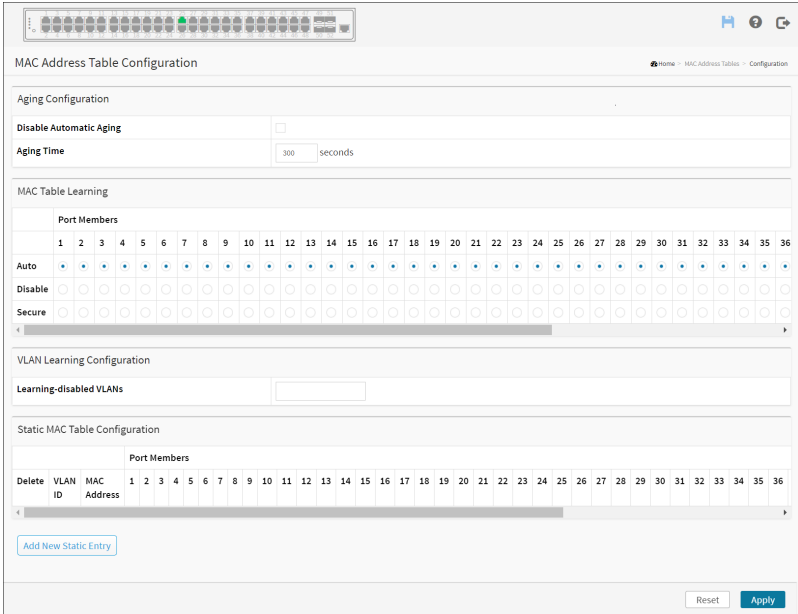

Web Interface

To configure the MAC Address Table in the web interface:

1. Click MAC Address Tables and Configuration.
2. Specify the Disable Automatic Aging and Aging Time.
3. Specify the Port Members (Auto, Disable, Secure).
4. Specify the Learning-disabled VLANs.
5. Add new Static entry, Specify the VLAN IP and Mac address, Port Members.

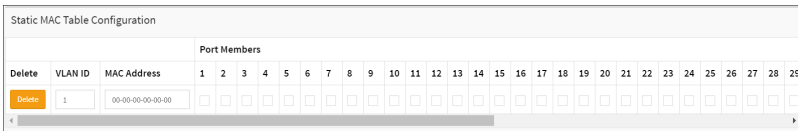

6. Click Apply.

■ Parameter description:**Aging Configuration:**

By default, dynamic entries are removed from the MAC table after 300 seconds. This removal is also called aging.

Configure aging time by entering a value here in seconds; for example, Age time seconds.

The allowed range is 10 to 1000000 seconds.

Disable the automatic aging of dynamic entries by checking Disable automatic aging.

MAC Table Learning:

If the learning mode for a given port is greyed out, another module is in control of the mode, so that it cannot be changed by the user. An example of such a module is the MAC-Based Authentication under 802.1X. Each port can do learning based upon the following settings:

Auto:

Learning is done automatically as soon as a frame with unknown SMAC is received.

Disable:

No learning is done.

Secure:

Only static MAC entries are learned, all other frames are dropped.

Note: Note: Make sure that the link used for managing the switch is added to the Static Mac Table before changing to secure learning mode, otherwise the management link is lost and can only be restored by using another non-secure port or by connecting to the switch via the serial interface.

VLAN Learning Configuration**Learning-disabled VLANs:**

This field shows the Learning-disabled VLANs. When a NEW MAC arrives into a learning-disabled VLAN, the MAC won't be learnt. By the default, the field is empty. More VLANs may be created by using a list syntax where the individual elements are separated by commas. Ranges are specified with a dash separating the lower and upper bound. The following example will create

VLANs 1, 10, 11, 12, 13, 200, and 300: 1,10-13,200,300. Spaces are allowed in between the delimiters.

Static MAC Table Configuration

The static entries in the MAC table are shown in this table. The static MAC table can contain 128 entries. The maximum of 128 entries is for the whole stack, and not per switch.

VLAN ID:

The VLAN ID of the entry.

MAC Address:

The MAC address of the entry.

Port Members:

Checkmarks indicate which ports are members of the entry. Check or uncheck as needed to modify the entry.

■ Buttons

Add a New Static Entry:

Click to add a new entry to the static MAC table. Specify the VLAN ID, MAC address, and port members for the new entry. Click “Apply”.

Delete:

Check to delete the entry. It will be deleted during the next save.

Apply:

Click to save changes.

Reset:

Click to undo any changes made locally and revert to previously saved values.

Information

Entries in the MAC Table are shown on this page. The MAC Table contains up to 8192 entries, and is sorted first by VLAN ID, then by MAC address.

Type	VLAN	MAC Address	Port Members																																
			CPU	1	2	3	4	5	6	7	8	9	10	11	12	13	14	15	16	17	18	19	20	21	22	23	24	25	26	27	28	29	30	3	
Static	1	33-33-00-00-00-01	✓	✓	✓	✓	✓	✓	✓	✓	✓	✓	✓	✓	✓	✓	✓	✓	✓	✓	✓	✓	✓	✓	✓	✓	✓	✓	✓	✓	✓	✓	✓	✓	✓
Static	1	33-33-FF-1C-E9-EB		✓	✓	✓	✓	✓	✓	✓	✓	✓	✓	✓	✓	✓	✓	✓	✓	✓	✓	✓	✓	✓	✓	✓	✓	✓	✓	✓	✓	✓	✓	✓	✓
Dynamic	1	94-C6-91-9B-2F-4D																																	✓
Static	1	FF-FF-FF-FF-FF-FF	✓	✓	✓	✓	✓	✓	✓	✓	✓	✓	✓	✓	✓	✓	✓	✓	✓	✓	✓	✓	✓	✓	✓	✓	✓	✓	✓	✓	✓	✓	✓	✓	✓

Web Interface

To Display MAC Address Table in the web interface:

1. Click MAC Address Table and Information.
2. If you want to auto-refresh the information then you need to evoke the “Auto-refresh”.
3. Click “Refresh” to refresh the MAC Address Table.

■ Parameter description:

Navigating the MAC Table

Each page shows up to 999 entries from the MAC table, default being 10, selected through the "entries per page" input field. When first visited, the web page will show the first 10 entries from the beginning of the MAC Table. The first displayed will be the one with the lowest VLAN ID and the lowest MAC address found in the MAC Table.

Type:

Indicates whether the entry is a static or a dynamic entry, 802.1x, DMS.

VLAN:

The VLAN ID of the entry.

MAC address:

The MAC address of the entry.

Port Members:

The ports that are members of the entry.

■ Buttons



Auto-refresh:

Check this box to refresh the page automatically. Automatic refresh occurs every 3 seconds.

Refresh:

Click to refresh the page.

First Page:

Updates the system log entries, turn to the first page.

Next Page:

Updates the system log entries, turn to the next page.

Note: 00-40-C7-73-01-29 : your switch MAC address (for IPv4)

33-33-00-00-00-01 : Destination MAC (for IPv6 Router Advertisement) (reference IPv6 RA.JPG)

33-33-00-00-00-02 : Destination MAC (for IPv6 Router Solicitation) (reference IPv6 RS.JPG)

33-33-FF-73-01-29 : Destination MAC (for IPv6 Neighbor Solicitation) (reference IPv6 DAD.JPG)

33-33-FF-A8-01-01: your switch MAC address (for IPv6 global IP)

FF-FF-FF-FF-FF-FF: for Broadcast.

Chapter 10 Multicast

Overview

The menu and the submenu are shown below:

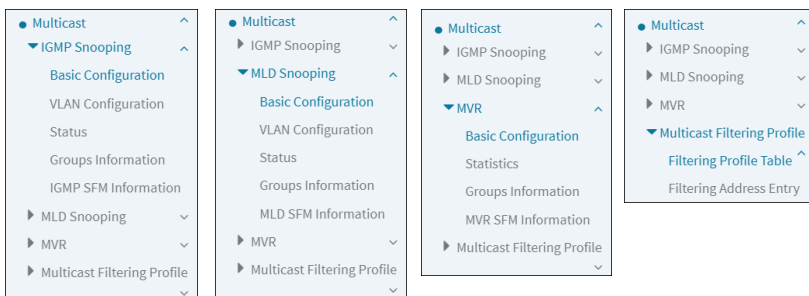

IGMP Snooping

The function, is used to establish the multicast groups to forward the multicast packet to the member ports, and, in nature, avoids wasting the bandwidth while IP multicast packets are running over the network. This is because a switch that does not support IGMP or IGMP Snooping cannot tell the multicast packet from the broadcast packet, so it can only treat them all as the broadcast packet. Without IGMP Snooping, the multicast packet forwarding function is plain and nothing is different from broadcast packet.

A switch supported IGMP Snooping with the functions of query, report and leave, a type of packet exchanged between IP Multicast Router/Switch and IP Multicast Host, can update the information of the Multicast table when a member (port) joins or leaves an IP Multicast Destination Address. With this function, once a switch receives an IP multicast packet, it will forward the packet to the members who joined in a specified IP multicast group before.

The packets will be discarded by the IGMP Snooping if the user transmits multicast packets to the multicast group that had not been built up in advance. IGMP mode enables the switch to issue IGMP function that you enable IGMP proxy or snooping on the switch, which connects to a router closer to the root of the tree. This interface is the upstream interface. The router on the upstream interface should be running IGMP. This page allows the user to inspect and configure the current PoE port settings and show all PoE Supply W.

Basic Configuration

The section describes how to set the basic IGMP snooping on the switch, which connects to a router closer to the root of the tree. This interface is the upstream interface. The router on the upstream interface should be running IGMP.

IGMP Snooping Basic Configuration

Global Configuration

Snooping Enabled on

Unregistered IPMCv4 Flooding Enabled

IGMP SSM Range 232.0.0.0 / 8

Leave Proxy Enabled

Proxy Enabled

Port Related Configuration

Port	Router Port	Fast Leave	Throttling	Filtering Profile
*	<input type="checkbox"/>	<input checked="" type="checkbox"/>	<>	<>
1	<input type="checkbox"/>	<input checked="" type="checkbox"/>	unlimited	- Preview
2	<input type="checkbox"/>	<input checked="" type="checkbox"/>	unlimited	- Preview
3	<input type="checkbox"/>	<input checked="" type="checkbox"/>	unlimited	- Preview

Reset Apply

Web Interface

To configure Power over Ethernet in the web interface:

1. Click Multicast, IGMP Snooping and Basic Configuration.
2. Evoke to select enable or disable which Global configuration
3. Evoke which port wants to become a Router Port or enable/disable the Fast Leave function.
4. Scroll to set the Throttling and Profile.
5. Click the Apply to save the setting.
6. If you want to cancel the setting then you need to click the Reset button. It will revert to previously saved values.

■ Parameter description:

Global Configuration

Snooping Enabled:

Enable the Global IGMP Snooping.

Unregistered IPMCv4 Flooding enabled:

Enable unregistered IPMCv4 traffic flooding. Unregistered IPMCv4 traffic is so-called unknown multicast.

After selected, the unregistered multicast stream will be forwarded like normal packets. Once you un-selected it, such stream will be discarded

IGMP SSM Range:

SSM (Source-Specific Multicast) Range allows the SSM-aware hosts and routers run the SSM service model for the groups in the address range. Format: (IP address/ sub mask)

Leave Proxy Enabled

Enable IGMP Leave Proxy. This feature can be used to avoid forwarding unnecessary leave messages to the router side.

Proxy Enabled:

Enable IGMP Proxy. This feature can be used to avoid forwarding unnecessary join and leave messages to the router side.

Port Related Configuration

Port:

It shows the physical Port index of switch.

Router Port:

Specify which ports act as router ports. A router port is a port on the Ethernet switch that leads towards the Layer 3 multicast device or IGMP querier.

If an aggregation member port is selected as a router port, the whole aggregation will act as a router port.

Fast Leave:

Enable the fast leave on the port.

Throttling:

Enable to limit the number of multicast groups to which a switch port can belong.

Profile:

Select the profile for this port. Click  to preview the page which list the rules associated with the selected profile.

■ Buttons

Apply:

Click to save changes.

Reset:

Click to undo any changes made locally and revert to previously saved values.

VLAN Configuration

The section describes the VLAN configuration setting process integrated with IGMP Snooping function. For Each setting page shows up to 99 entries from the VLAN table, default being 20, selected through the "entries per page" input field. When first visited, the web page will show the first 20 entries from the beginning of the VLAN Table. The first displayed will be the one with the lowest VLAN ID found in the VLAN Table. The "VLAN" input fields allow the user to select the starting point in the VLAN Table. Clicking the button will update the displayed table starting from that or the next closest VLAN Table match.

VLAN ID	Snooping Enabled	Querier Election	Querier Address	Compatibility	PRI	RV	QI (sec)	QRI (0.1 sec)	LLQI (0.1 sec)	URI (sec)
1	<input checked="" type="checkbox"/>	<input checked="" type="checkbox"/>	0.0.0.0	IGMP-Auto	0	3	125	100	100	1

Web Interface

To configure the IGMP Snooping VLAN Configuration in the web interface:

1. Click Multicast, IGMP Snooping and VLAN Configuration.
2. Click to add new IGMP VLAN.
3. Click the Apply to save the setting.

4. If you want to cancel the setting then you need to click the Reset button. It will revert to previously saved values.

■ **Parameter description:**

Start from Vlan:

You can click them Refreshes the displayed table starting from the "VLAN" input fields.

Delete:

Check to delete the entry. The designated entry will be deleted during the next save.

VLAN ID:

It displays the VLAN ID of the entry.

Snooping Enabled:

Enable the per-VLAN IGMP Snooping. Only up to 32 VLANs can be selected.

IGMP Querier:

Enable to join IGMP Querier election in the VLAN. Disable to act as an IGMP Non-Querier.

Compatibility:

Compatibility is maintained by hosts and routers taking appropriate actions depending on the versions of IGMP operating on hosts and routers within a network. The allowed selection is IGMP-Auto, Forced IGMPv1, Forced IGMPv2, Forced IGMPv3, default compatibility value is IGMP-Auto.

Rv:

Robustness Variable. The Robustness Variable allows tuning for the expected packet loss on a network. The allowed range is 1 to 255; default robustness variable value is 2.

QI(sec):

Query Interval. The Query Interval is the interval between General Queries sent by the Querier. The allowed range is 1 to 31744 seconds; default query interval is 125 seconds.

QRI(0.1 sec):

Query Response Interval. The Max Response Time used to calculate the Max Resp Code inserted into the periodic General Queries. The allowed range is 0

to 31744 in tenths of seconds; default query response interval is 100 in tenths of seconds (10 seconds).

LLQI (0.1 sec):

Last Member Query Interval. The Last Member Query Time is the time value represented by the Last Member Query Interval, multiplied by the Last Member Query Count. The allowed range is 0 to 31744 in tenths of seconds; default last member query interval is 10 in tenths of seconds (1 second).

URI(sec):

Unsolicited Report Interval. The Unsolicited Report Interval is the time between repetitions of a host's initial report of membership in a group. The allowed range is 0 to 31744 seconds, default unsolicited report interval is 1 second.

■ Buttons

Apply:

Click to save changes.

Reset:

Click to undo any changes made locally and revert to previously saved values.

Status

After you complete the IGMP Snooping configuration, then you could to let the switch display the IGMP Snooping Status. The Section provides you to let switch to display the IGMP Snooping detail status.

IGMP Snooping Status Home > Multicast > IGMP Snooping > Status

Auto-refresh Refresh Clear

Statistics

VLAN ID	Querier Version	Host Version	Querier Status	Queries Transmitted	Queries Received	V1 Reports Received	V2 Reports Received	V3 Reports Received	V2 Leaves Received
1	v3	v3	ACTIVE	4199	0	0	0	86	0

Router Port

Port	Status
1	-
2	-
3	-
4	-
5	-
6	-
7	-
8	-

Web Interface

To display the IGMP Snooping status in the web interface:

1. Click Multicast, IGMP Snooping and Status.
2. If you want to auto-refresh the information then you need to evoke the “Auto-refresh”.
3. Click “Refresh” to refresh the IGMP Snooping Status.

■ Parameter description:

Statistic

VLAN ID:

The VLAN ID of the entry.

Querier Version:

Working Querier Version currently.

Host Version:

Working Host Version currently.

Querier Status:

Shows the Querier status is “ACTIVE” or “IDLE”.

“DISABLE” denotes the specific interface is administratively disabled.

Queries Transmitted:

The number of Transmitted Queries.

Queries Received:

The number of Received Queries.

V1 Reports Received:

The number of Received V1 Reports.

V2 Reports Received:

The number of Received V2 Reports.

V3 Reports Received:

The number of Received V3 Reports.

V2 Leaves Received:

The number of Received V2 Leaves.

Router Port

Display which ports act as router ports. A router port is a port on the Ethernet switch that leads towards the Layer 3 multicast device or IGMP querier. Static denotes the specific port is configured to be a router port. Dynamic denotes the specific port is learnt to be a router port. Both denote the specific port is configured or learnt to be a router port.

Port:

Switch port number.

Status:

Indicate whether specific port is a router port or not.

■ Buttons

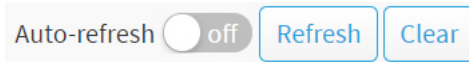

Auto-refresh:

Check this box to refresh the page automatically. Automatic refresh occurs every 3 seconds.

Refresh:

Click to refresh the page.

Clear:

Click to clear the page.

Group Information

After you complete to set the IGMP Snooping function then you could let the switch to display the IGMP Snooping Group Information. Entries in the IGMP Group Table are shown on this page. The IGMP Group Table is sorted first by VLAN ID, and then by group. This will use the last entry of the currently displayed table as a basis for the next lookup. When the end is reached the text “No more entries” is shown in the displayed table. Use the button to start over.

The Next Page will use the last entry of the currently displayed table as a basis for the next lookup. When the end is reached the text “No more entries” is shown in the displayed table. Use the First Page button to start over.

Show entries:

You can choose how many items you want to show up.

VLAN ID:

VLAN ID of the group.

Groups:

Group address of the group displayed.

Port Members:

Ports under this group.

■ Buttons



Auto-refresh:

Check this box to refresh the page automatically. Automatic refresh occurs every 3 seconds.

Refresh:

Click to refresh the page.

First Page:

Updates the system log entries, turn to the first page.

Next Page:

Updates the group information entries, turn to the next page.

IGMP SFM Information

Entries in the IGMP SFM Information Table are shown on this page. The IGMP SFM (Source-Filtered Multicast) Information Table also contains the SSM (Source-Specific Multicast) information. This table is sorted first by VLAN ID, then by group, and then by Port. Different source addresses belong to the same group are treated as single entry.

IGMP SFM Information

Home > Multicast > IGMP Snooping > IGMP SFM Information

Auto-refresh Refresh First Page Next Page

Start from VLAN 1 and group address: 224.0.0.0 20 entries per page.

VLAN ID	Group	Port	Mode	Source Address	Type	Hardware Filter/Switch
1	239.255.255.250	25	Exclude	None	Deny	Yes

Web Interface

To display the IGMP SFM Information in the web interface:

1. Click Multicast, IGMP Snooping and IGMP SFM Information.
2. If you want to auto-refresh the information then you need to evoke the “Auto-refresh”.
3. Click “Refresh” to refresh an entry of the IGMP Snooping Groups Information.
4. Click First/Next Page to change page.

■ Parameter description:

Navigating the IGMP SFM Information Table

Each page shows up to 99 entries from the IGMP SFM Information table, default being 20, selected through the “entries per page” input field. When first visited, the web page will show the first 20 entries from the beginning of the IGMP SFM Information Table.

The “Start from VLAN”, and “group” input fields allow the user to select the starting point in the IGMP SFM Information Table. Clicking the Refresh button will update the displayed table starting from that or the closest next IGMP SFM Information Table match. In addition, the two input fields will - upon a Refresh button click - assume the value of the first displayed entry, allowing for continuous refresh with the same start address.

The Next Page will use the last entry of the currently displayed table as a basis for the next lookup. When the end is reached the text “No more entries” is shown in the displayed table. Use the First Page button to start over.

Show entries:

You can choose how many items you want to show up.

VLAN ID:

VLAN ID of the group.

Group:

Group address of the group displayed.

Port:

Switch port number.

Mode:

Indicates the filtering mode maintained per (VLAN ID, port number, Group Address) basis. It can be either Include or Exclude.

Source Address:

IP Address of the source. Currently, system limits the total number of IP source addresses for filtering to be 128.

Type:

Indicates the Type. It can be either Allow or Deny.

Hardware Filter/Switch:

Indicates whether data plane destined to the specific group address from the source IPv4 address could be handled by chip or not.

■ Buttons



Auto-refresh:

Check this box to refresh the page automatically. Automatic refresh occurs every 3 seconds.

Refresh:

Click to refresh the page.

First Page:

Updates the system log entries, turn to the first page.

Next Page:

Updates the group information entries, turn to the next page.

MLD Snooping

Curiously enough, a network node that acts as a source of IPv6 multicast traffic is only an indirect participant in MLD snooping—it just provides multicast traffic, and MLD doesn't interact with it. (Note, however, that in an application like desktop conferencing a network node may act as both a source and an MLD host; but MLD interacts with that node only in its role as an MLD host.)

A source node creates multicast traffic by sending packets to a multicast address. In IPv6, addresses with the first eight bits set (that is, "FF" as the first two characters of the address) are multicast addresses, and any node that listens to such an address will receive the traffic sent to that address. Application software running on the source and destination systems cooperates to determine what multicast address to use. (Note that this is a function of the application software, not of MLD.)

When MLD snooping is enabled on a VLAN, the switch acts to minimize unnecessary multicast traffic. If the switch receives multicast traffic destined for a given multicast address, it forwards that traffic only to ports on the VLAN that have MLD hosts for that address. It drops that traffic for ports on the VLAN that have no MLD hosts.

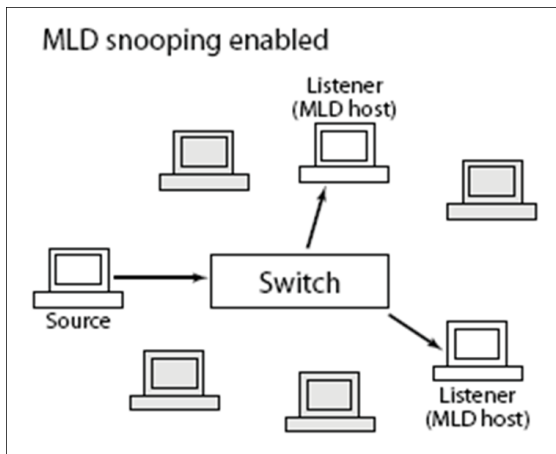

Basic Configuration

The section will let you understand how to configure the MLD Snooping basic configuration and the parameters.

MLD Snooping Basic Configuration

Home - Multicast - MLD Snooping - Basic Configuration

Global Configuration

Snooping Enabled Off

Unregistered IPMCv6 Flooding Enabled

MLD SSM Range ff02::1:3 / 96

Leave Proxy Enabled

Proxy Enabled

Port Related Configuration

Port	Router Port	Fast Leave	Throttling	Filtering Profile
*	<input type="checkbox"/>	<input type="checkbox"/>	<->	<-
1	<input type="checkbox"/>	<input type="checkbox"/>	unlimited	<- Preview
2	<input type="checkbox"/>	<input type="checkbox"/>	unlimited	<- Preview
3	<input type="checkbox"/>	<input type="checkbox"/>	unlimited	<- Preview

Reset Apply

Web Interface

To configure the MLD Snooping Configuration in the web interface:

1. Click Multicast, MLD Snooping and Basic Configuration.
2. Evoke to on or off the Global configuration parameters.
3. Evoke the port to join Router port and Fast Leave.
4. Scroll to select the Throttling mode with unlimited or 1 to 10.
5. Scroll to set the Profile.
6. Click the apply to save the setting.
7. If you want to cancel the setting then you need to click the Reset button. It will revert to previously saved values.

■ Parameter description:

Global Configuration

Snooping Enabled:

Enable the Global MLD Snooping.

Unregistered IPMCv6 Flooding enabled:

Enable unregistered IPMCv6 traffic flooding.

The flooding control takes effect only when MLD Snooping is enabled.

When MLD Snooping is disabled, unregistered IPMCv6 traffic flooding is always active in spite of this setting.

MLD SSM Range:

SSM (Source-Specific Multicast) Range allows the SSM-aware hosts and routers run the SSM service model for the groups in the address (Using IPv6 Address) range.

Leave Proxy Enabled:

Enable MLD Leave Proxy. This feature can be used to avoid forwarding unnecessary leave messages to the router side.

Proxy Enabled:

Enable MLD Proxy. This feature can be used to avoid forwarding unnecessary join and leave messages to the router side.

Port Related Configuration

Router Port:

Specify which ports act as router ports. A router port is a port on the Ethernet switch that leads towards the Layer 3 multicast device or MLD querier. If an aggregation member port is selected as a router port, the whole aggregation will act as a router port.

Fast Leave:

To evoke to enable the fast leave on the port.

Throttling:

Enable to limit the number of multicast groups to which a switch port can belong.

Filtering Profile:

You can select profile when you edit in Multicast Filtering Profile.

■ Buttons

Apply:

Click to save changes.

Reset:

Click to undo any changes made locally and revert to previously saved values.

VLAN Configuration

When MLD snooping is enabled on a VLAN, the switch acts to minimize unnecessary multicast traffic. If the switch receives multicast traffic destined for a given multicast address, it forwards that traffic only to ports on the VLAN that have MLD hosts for that address. It drops that traffic for ports on the VLAN that have no MLD hosts.

The will use the last entry of the currently displayed entry as a basis for the next lookup. When the end is reached the text “No more entries” is shown in the displayed table. Use the button to start over.

VLAN ID	Snooping Enabled	Querier Election	Compatibility	PRI	RV	QI (sec)	QRI (0.1 sec)	LLQI (0.1 sec)	URI (sec)
1	<input type="checkbox"/>	<input checked="" type="checkbox"/>	MLD-Auto	0	2	125	100	10	1

Web Interface

To configure the MLD Snooping VLAN Configuration in the web interface:

1. Click Multicast, MLD Snooping and VLAN Configuration.
2. Click Add New MLD VLAN.
3. Specify the VLAN ID with entries per page.

■ Parameter description:

Delete:

Check to delete the entry. The designated entry will be deleted during the next save.

VLAN ID:

It displays the VLAN ID of the entry.

Snooping Enabled:

Enable the per-VLAN IGMP Snooping. Only up to 32 VLANs can be selected.

MLD Querier:

Enable to join IGMP Querier election in the VLAN. Disable to act as an IGMP Non-Querier.

Compatibility:

Compatibility is maintained by hosts and routers taking appropriate actions depending on the versions of IGMP operating on hosts and routers within a network. The allowed selection is IGMP-Auto, Forced IGMPv1, Forced IGMPv2, default compatibility value is IGMP-Auto.

RV:

Robustness Variable. The Robustness Variable allows tuning for the expected packet loss on a network. The allowed range is 1 to 255; default robustness variable value is 2.

QI(sec):

Query Interval. The Query Interval is the interval between General Queries sent by the Querier. The allowed range is 1 to 31744 seconds; default query interval is 125 seconds.

QRI(0.1sec):

Query Response Interval. The Max Response Time used to calculate the Max Resp Code inserted into the periodic General Queries. The allowed range is 0 to 31744 in tenths of seconds; default query response interval is 100 in tenths of seconds (10 seconds).

LLQI (LMQI for IGMP):

Last Member Query Interval. The Last Member Query Time is the time value represented by the Last Member Query Interval, multiplied by the Last Member Query Count. The allowed range is 0 to 31744 in tenths of seconds; default last member query interval is 10 in tenths of seconds (1 second).

URI(sec):

Unsolicited Report Interval. The Unsolicited Report Interval is the time between repetitions of a host's initial report of membership in a group. The allowed range is 0 to 31744 seconds, default unsolicited report interval is 1 second.

■ Buttons

Apply:

Click to save changes.

Reset:

Click to undo any changes made locally and revert to previously saved values.

Status

The section describes when you complete the MLD Snooping and how to display the MLD Snooping Status and detail information. It will help you to find out the detail information of MLD Snooping status.

VLAN ID	Querier Version	Host Version	Querier Status	Queries Transmitted	Queries Received	V1 Reports Received	V2 Reports Received	V1 Leaves Received
No entries								

Port	Status
1	-
2	-
3	-
4	-
5	-
6	-
7	-
8	-
9	-

Web Interface

To display the MLD Snooping Status in the web interface:

1. Click Multicast, MLD Snooping and Status.
2. If you want to auto-refresh the information then you need to evoke the “Auto-refresh”.
3. Click “Refresh” to refresh an entry of the MLD Snooping Status Information.

■ Parameter description:

VLAN ID:

The VLAN ID of the entry.

Querier Version:

Working Querier Version currently.

Host Version:

Working Host Version currently.

Querier Status:

Show the Querier status is “ACTIVE” or “IDLE”.

“DISABLE” denotes the specific interface is administratively disabled.

Queries Transmitted:

The number of Transmitted Queries.

Queries Received:

The number of Received Queries.

V1 Reports Received:

The number of Received V1 Reports.

V2 Reports Received:

The number of Received V2 Reports.

V1 Leaves Received:

The number of Received V1 Leaves.

Router Port

Display which ports act as router ports. A router port is a port on the Ethernet switch that leads towards the Layer 3 multicast device or MLD querier.

Static denotes the specific port is configured to be a router port.

Dynamic denotes the specific port is learnt to be a router port.

Both denote the specific port is configured or learnt to be a router port.

Port:

Switch port number.

Status:

Indicate whether specific port is a router port or not.

■ **Buttons**



Auto-refresh:

Check this box to refresh the page automatically. Automatic refresh occurs every 3 seconds.

Refresh:

Click to refresh the page.

Clear:

Click to clear the page.

Groups Information

Entries in the MLD Group Table are shown on this page. The MLD Group Table is sorted first by VLAN ID, and then by group.

MLD Snooping Group Information

Home > Multicast > MLD Snooping > Groups Information

Auto-refresh Off Refresh First Page Next Page

Start from VLAN: 1 and group address: mcast: 20 entries per page.

Port Members	
VLAN ID	Groups
	1 2 3 4 5 6 7 8 9 10 11 12 13 14 15 16 17 18 19 20 21 22 23 24 25 26 27 28 29 30 31 32 33 34 35 36 37 38 39

No more entries

Web Interface

To display the MLD Snooping Group information in the web interface:

1. Click Multicast, MLD Snooping and Group Information.
2. If you want to auto-refresh the information then you need to evoke the “Auto-refresh”.
3. Click “Refresh” to refresh an entry of the MLD Snooping Group Information.
4. Click First/Next Page to change page.

■ Parameter description:

Navigating the MLD Group Table

Each page shows up to 99 entries from the MLD Group table, default being 20, selected through the “entries per page” input field. When first visited, the web page will show the first 20 entries from the beginning of the MLD Group Table.

The “Start from VLAN”, and “group” input fields allow the user to select the starting point in the MLD Group Table. Clicking the Refresh button will update the displayed table starting from that or the closest next MLD Group Table match. In addition, the two input fields will - upon a Refresh button click - assume the value of the first displayed entry, allowing for continuous refresh with the same start address.

The Next Page will use the last entry of the currently displayed table as a basis for the next lookup. When the end is reached the text "No more entries" is shown in the displayed table. Use the First Page button to start over.

VLAN ID:

VLAN ID of the group.

Groups:

Group address of the group displayed.

Port Members:

Ports under this group.

Show entries:

You can choose how many items you want to show up.

■ Buttons



Auto-refresh:

Check this box to refresh the page automatically. Automatic refresh occurs every 3 seconds.

Refresh:

Click to refresh the page.

First Page:

Updates the system log entries, turn to the first page.

Next Page:

Updates the group information entries, turn to the next page.

MLD SFM Information

Entries in the MLD SFM Information Table are shown on this page. The MLD SFM (Source-Filtered Multicast) Information Table also contains the SSM (Source-Specific Multicast) information. This table is sorted first by VLAN ID, then by group, and then by Port. Different source addresses belong to the same group are treated as single entry.

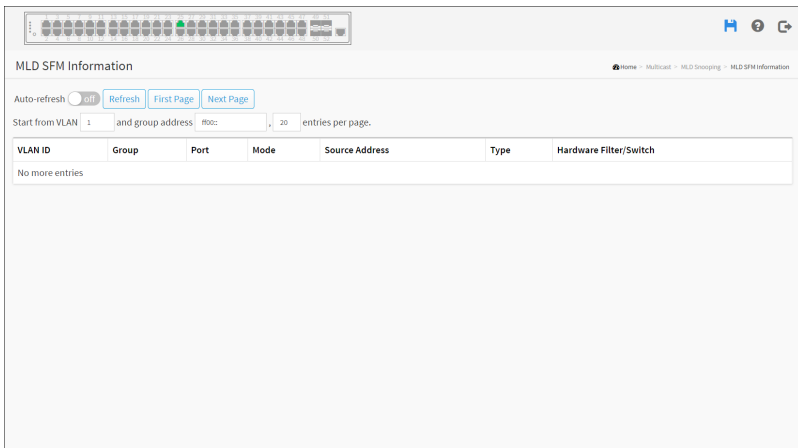

Web Interface

To display the MLD SFM Information in the web interface:

1. Click Multicast, MLD Snooping and MLD SFM Information.
2. If you want to auto-refresh the information then you need to evoke the “Auto-refresh”.
3. Click “Refresh” to refresh an entry of the MLD SFM Information.
4. Click First/Next Page to change page.

■ Parameter description:

Navigating the MLD SFM Information Table

Each page shows up to 99 entries from the MLD SFM Information table, default being 20, selected through the “entries per page” input field. When first

visited, the web page will show the first 20 entries from the beginning of the MLD SFM Information Table.

The “Start from VLAN”, and “group” input fields allow the user to select the starting point in the MLD SFM Information Table. Clicking the Refresh button will update the displayed table starting from that or the closest next MLD SFM Information Table match. In addition, the two input fields will - upon a Refresh button click - assume the value of the first displayed entry, allowing for continuous refresh with the same start address.

The Next Page will use the last entry of the currently displayed table as a basis for the next lookup. When the end is reached the text “No more entries” is shown in the displayed table. Use the First Page button to start over.

VLAN ID:

VLAN ID of the group.

Group:

IP Multicast Group address.

Port:

Switch port number.

Mode:

Indicates the filtering mode maintained per (VLAN ID, port number, Group Address) basis. It can be either Include or Exclude.

Source Address:

IP Address of the source. Currently, system limits the total number of IP source addresses for filtering to be 128.

Type:

Indicates the Type. It can be either Allow or Deny.

Hardware Filter/Switch:

Indicates whether data plane destined to the specific group address from the source IPv6 address could be handled by chip or not.

■ Buttons



Auto-refresh:

Check this box to refresh the page automatically. Automatic refresh occurs every 3 seconds.

Refresh:

Click to refresh the page.

First Page:

Updates the system log entries, turn to the first page.

Next Page:

Updates the group information entries, turn to the next page.

MVR

The MVR feature enables multicast traffic forwarding on the Multicast VLAN. In a multicast television application, a PC or a television with a set-top box can receive the multicast stream. Multiple set-top boxes or PCs can be connected to one subscriber port, which is a switch port configured as an MVR receiver port. When a subscriber selects a channel, the set-top box or PC sends an IGMP join message to Switch A to join the appropriate multicast. Uplink ports that send and receive multicast data to and from the multicast VLAN are called MVR source ports.

Basic Configuration

MVR Configurations

MVR Mode Off

VLAN Interface Setting (Role Inactive / Source / Receiver)

Delete	MVR VID	MVR Name	IGMP Address	Mode	Tagging	Priority	LLQI	Interface Channel Profile
Add New MVR VLAN								

Immediate Leave Setting

Port	Immediate Leave
*	-->
1	Disabled
2	Disabled
3	Disabled
4	Disabled

Reset Apply

Web Interface

To configure the MVR Configuration in the web interface:

1. Click Multicast, MVR and Basic Configuration.
2. Scroll the MVR mode to enable or disable and Scroll to set all parameters.
3. Click “Add New MVR VLAN”.
4. Specify MVR VID, MVR Name, IGMP Address, Mode, Tagging, Priority, LLQI, Interface Channel Profile.
5. Select which port to Click Immediate Leave.
6. Click the apply to save the setting.

7. If you want to cancel the setting then you need to click the Reset button. It will revert to previously saved values

■ **Parameter description:**

MVR Mode:

Enable/Disable the Global MVR.

The Unregistered Flooding control depends on the current configuration in IGMP/MLD Snooping. It is suggested to enable Unregistered Flooding control when the MVR group table is full.

MVR VID:

Specify the Multicast VLAN ID.

Be Caution: MVR source ports are not recommended to be overlapped with management VLAN ports.

MVR Name:

MVR Name is an optional attribute to indicate the name of the specific MVR VLAN. Maximum length of the MVR VLAN Name string is 32. MVR VLAN Name can only contain alphabets or numbers. MVR VLAN name can be edited for the existing MVR VLAN entries or it can be added to the new entries.

IGMP Address:

Define the IPv4 address as source address used in IP header for IGMP control frames.

The default IGMP address is not set (0.0.0.0).

When the IGMP address is not set, system uses IPv4 management address of the IP interface associated with this VLAN.

When the IPv4 management address is not set, system uses the first available IPv4 management address.

Otherwise, system uses a pre-defined value. By default, this value will be 192.0.2.1.

Mode:

Specify the MVR mode of operation. In Dynamic mode, MVR allows dynamic MVR membership reports on source ports. In Compatible mode, MVR membership reports are forbidden on source ports. The default is Dynamic mode.

Tagging:

Specify whether the traversed IGMP/MLD control frames will be sent as Untagged or Tagged with MVR VID. The default is tagged.

Priority:

Specify how the traversed IGMP/MLD control frames will be sent in prioritized manner. The default Priority is 0.

LLQI:

Define the maximum time to wait for IGMP/MLD report memberships on a receiver port before removing the port from multicast group membership. The value is in units of tenths of a seconds. The range is from 0 to 31744. The default LLQI is 5 tenths or one-half second.

Interface Channel Profile:

When the MVR VLAN is created, select the profile to expand the corresponding multicast channel settings for the specific MVR VLAN. The file established on Filtering Profile Table.

Port:

The logical port for the settings.

Port Role:

Configure an MVR port of the designated MVR VLAN as one of the following roles.

Inactive: The designated port does not participate MVR operations.

Source: Configure uplink ports that receive and send multicast data as source ports. Subscribers cannot be directly connected to source ports.

Receiver: Configure a port as a receiver port if it is a subscriber port and should only receive multicast data. It does not receive data unless it becomes a member of the multicast group by issuing IGMP/MLD messages.

Be Caution: MVR source ports are not recommended to be overlapped with management VLAN ports. Select the port role by clicking the Role symbol to switch the setting. I indicates Inactive; S indicates Source; R indicates Receiver. The default Role is Inactive.

Immediate Leave:

Enable the fast leave on the port.

■ Buttons

Add New MVR VLAN:

Click to add new mvr vlan. Specify MVR VID, MVR Name, IGMP Address, Mode, Tagging, Priority, LLQI, Interface Channel Profile. Click "Apply"

Delete:

Check to delete the entry. The designated entry will be deleted during the next save.

Apply:

Click to save changes.

Reset:

Click to undo any changes made locally and revert to previously saved values.

Statistics

The section describes the switch will display the MVR detail Statistics after you had configured MVR on the switch. It provides the detail MVR Statistics Information

VLAN ID	IGMP/MLD Queries Received	IGMP/MLD Queries Transmitted	IGMPv1 Joins Received	IGMPv2/MLDv1 Reports Received	IGMPv3/MLDv2 Reports Received	IGMPv2/MLDv1 Leaves Received
No more entries						

Web Interface

To display the MVR Statistics Information in the web interface:

1. Click Multicast, MVR and Statistics.
2. If you want to auto-refresh the information then you need to evoke the "Auto-refresh".
3. To click the "Refresh" to refresh an entry of the MVR Statistics Information.

■ Parameter description:

VLAN ID:

The Multicast VLAN ID.

IGMP/MLD Queries Received:

The number of Received Queries for IGMP and MLD, respectively.

IGMP/MLD Queries Transmitted:

The number of Transmitted Queries for IGMP and MLD, respectively.

IGMPv1 Joins Received:

The number of Received IGMPv1 Join's.

IGMPv2/MLDv1 Report's Received:

The number of Received IGMPv2 Join's and MLDv1 Report's, respectively.

IGMPv3/MLDv2 Report's Received:

The number of Received IGMPv3 Join's and MLDv2 Report's, respectively.

IGMPv2/MLDv1 Leave's Received:

The number of Received IGMPv2 Leave's and MLDv1 Done's, respectively.

■ Buttons

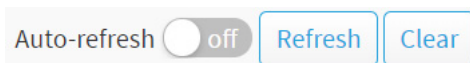

Auto-refresh:

Check this box to refresh the page automatically. Automatic refresh occurs every 3 seconds.

Refresh:

Click to refresh the page.

Clear:

Click to clear all Statistics counters.

MVR Groups Information

The section describes user could display the MVR Groups detail information on the switch. Entries in the MVR Group Table are shown on this page. The MVR Group Table is sorted first by VLAN ID, and then by group.

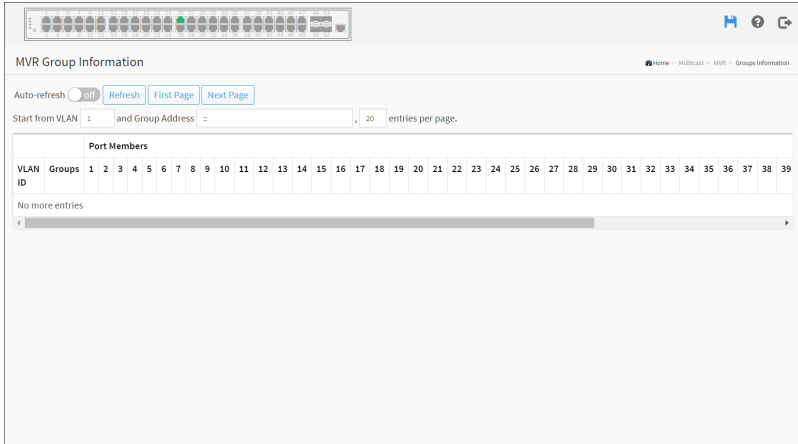

Web Interface

To display the MVR Groups Information in the web interface:

1. Click Multicast, MVR and Groups Information.
2. If you want to auto-refresh the information then you need to evoke the “Auto-refresh”.
3. Click “Refresh” to refresh the entry of the MVR Groups Information.
4. Click First/Next Page to change page.

■ Parameter description:

Navigating the MVR Channels (Groups) Information Table

Each page shows up to 99 entries from the MVR Group table, default being 20, selected through the “entries per page” input field. When first visited, the web page will show the first 20 entries from the beginning of the MVR Channels (Groups) Information Table.

The “Start from VLAN”, and “Group Address” input fields allow the user to select the starting point in the MVR Channels (Groups) Information Table. Clicking the Refresh button will update the displayed table starting from that or the closest next MVR Channels (Groups) Information Table match. In addition, the two input fields will - upon a Refresh button click - assume the value of the first displayed entry, allowing for continuous refresh with the same start address.

The Next Page will use the last entry of the currently displayed table as a basis for the next lookup. When the end is reached the text “No more entries” is shown in the displayed table. Use the First Page button to start over.

MVR Channels (Groups) Information Table Columns

Show entries:

You can choose how many items you want to show up.

VLAN ID:

VLAN ID of the group.

Groups:

Group ID of the group displayed.

Port Members:

Ports under this group.

■ Buttons



Auto-refresh:

Check this box to refresh the page automatically. Automatic refresh occurs every 3 seconds.

Refresh:

Click to refresh the page.

First Page:

Updates the system log entries, turn to the first page.

Next Page:

Updates the group information entries, turn to the next page.

MVR SFM Information

The MVR SFM (Source-Filtered Multicast) Information Table also contains the SSM (Source-Specific Multicast) information. This table is sorted first by VLAN ID, then by group, and then by Port. Different source addresses belong to the same group are treated as single entry.

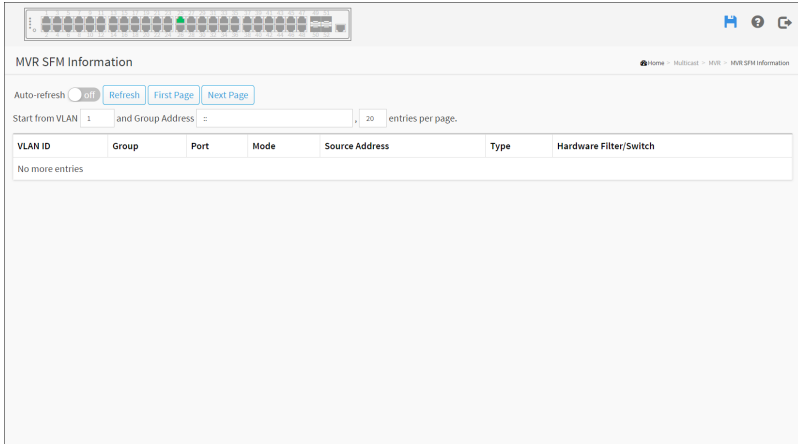

Web Interface

To display the MVR SFM Information in the web interface:

1. Click Multicast, MVR and MVR SFM Information.
2. If you want to auto-refresh the information then you need to evoke the “Auto-refresh”.
3. To click the “Refresh” to refresh an entry of the MVR Groups Information.
4. Click First/Next Page to change page.

■ Parameter description:

Navigating the MVR SFM Information Table

Each page shows up to 99 entries from the MVR SFM Information Table, default being 20, selected through the “entries per page” input field. When first visited, the web page will show the first 20 entries from the beginning of the MVR SFM Information Table.

The “Start from VLAN”, and “Group Address” input fields allow the user to select the starting point in the MVR SFM Information Table. Clicking the Refresh button will update the displayed table starting from that or the closest next MVR SFM Information Table match. In addition, the two input fields will - upon a Refresh button click - assume the value of the first displayed entry, allowing for continuous refresh with the same start address.

The Next Page will use the last entry of the currently displayed table as a basis for the next lookup. When the end is reached the text “No more entries” is shown in the displayed table. Use the First Page button to start over.

MVR SFM Information Table Columns

Show entries:

You can choose how many items you want to show up.

VLAN ID:

VLAN ID of the group.

Group:

IP Multicast Group address.

Port:

Switch port number.

Mode:

Indicates the filtering mode maintained per (VLAN ID, port number, Group Address) basis. It can be either Include or Exclude.

Source Address:

IP Address of the source. Currently, system limits the total number of IP source addresses for filtering to be 128. When there is not any source filtering address, the text “None” is shown in the Source Address field.

Type:

Indicates the Type. It can be either Allow or Deny.

Hardware Filter/Switch:

Indicates whether data plane destined to the specific group address from the source IPv4/IPv6 address could be handled by chip or not.

■ Buttons



Auto-refresh:

Check this box to refresh the page automatically. Automatic refresh occurs every 3 seconds.

Refresh:

Click to refresh the page.

First Page:

Updates the system log entries, turn to the first page.

Next Page:

Updates the group information entries, turn to the next page.

Multicast Filtering Profile

Filtering Profile Table

The IPMC profile is used to deploy the access control on IP multicast streams. It is allowed to create at maximum 64 Profiles with at maximum 128 corresponding rules for each.

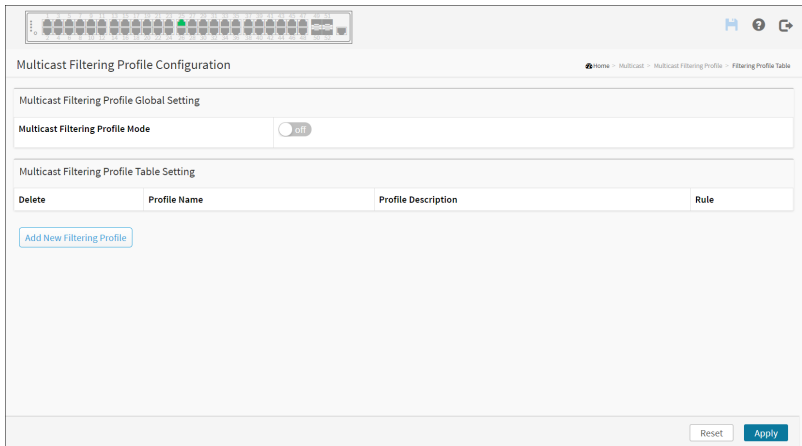

Web Interface

To configure the IPMC Profile Configuration in the web interface:

1. Click Multicast, Multicast Filtering Profile and Filtering Profile Table.
2. Scroll the Multicast Filtering Profile mode to enable or disable.
3. Click “Add New Filtering Profile”.

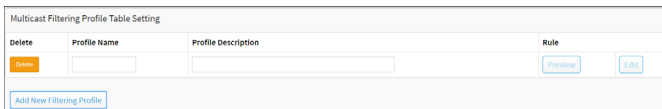

4. Specify Profile Name, Profile Description and Rule.
5. Click the apply to save the setting.
6. If you want to cancel the setting then you need to click the Reset button. It will revert to previously saved values.

■ Parameter description:

Multicast Filtering Profile Mode:

Enable/Disable the Multicast Filtering Profile.

System starts to do filtering based on profile settings only when the global profile mode is enabled.

Profile Name:

The name used for indexing the profile table.

Each entry has the unique name which is composed of at maximum 16 alphabetic and numeric characters.

Profile Description:

Additional description, which is composed of at maximum 64 alphabetic and numeric characters, about the profile.

No blank or space characters are permitted as part of description. Use “_” or “-” to separate the description sentence.

Rule:

When the profile is created, click the edit button to enter the rule setting page of the designated profile. Summary about the designated profile will be shown by clicking the view button. You can manage or inspect the rules of the designated profile by using the following buttons:

Preview: Preview the rules associated with the designated profile.

Edit: Adjust the rules associated with the designated profile.

Profile Name & Index	Entry Name	Address Range	Action	Log

[Back to Configuration](#)
[Reset](#)
[Commit](#)
[Add Last Rule](#)

Profile Name & Index:

The name of the designated profile to be associated. This field is not editable.

Entry Name:

The name used in specifying the address range used for this rule.

Only the existing profile address entries will be chosen in the selected box. This field is not allowed to be selected as none (“-”) while the Rule Settings Table is committed.

Address Range:

The corresponding address range of the selected profile entry. This field is not editable and will be adjusted automatically according to the selected profile entry.

Action:

Indicates the learning action upon receiving the Join/Report frame that has the group address matches the address range of the rule.

Permit: Group address matches the range specified in the rule will be learned.

Deny: Group address matches the range specified in the rule will be dropped.

Log:

Indicates the logging preference upon receiving the Join/Report frame that has the group address matches the address range of the rule.

Enable: Corresponding information of the group address, that matches the range specified in the rule, will be logged.

Disable: Corresponding information of the group address, that matches the range specified in the rule, will not be logged.

Rule Management Buttons:

You can manage rules and the corresponding precedence order by using the following buttons:

: Insert a new rule before the current entry of rule.

: Delete the current entry of rule.

: Moves the current entry of rule up in the list.

: Moves the current entry of rule down in the list.

■ Buttons**Add New Filtering Profile:**

Click to add new IPMC profile. Specify the name and configure the new entry. Click “Save”.

Delete:

Check to delete the entry.

The designated entry will be deleted during the next save.

Apply:

Click to save changes.

Reset:

Click to undo any changes made locally and revert to previously saved values.

Add Last Rule:

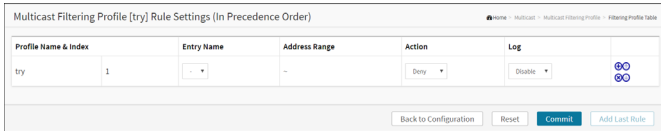

Click to add a new rule in the end of the specific profile's rule list. Specify the address entry and configure the new entry. Click “Apply”.

Filtering Address Entry

This page provides address range settings used in IPMC profile.

The address entry is used to specify the address range that will be associated with IPMC Profile. It is allowed to create at maximum 128 address entries in the system.

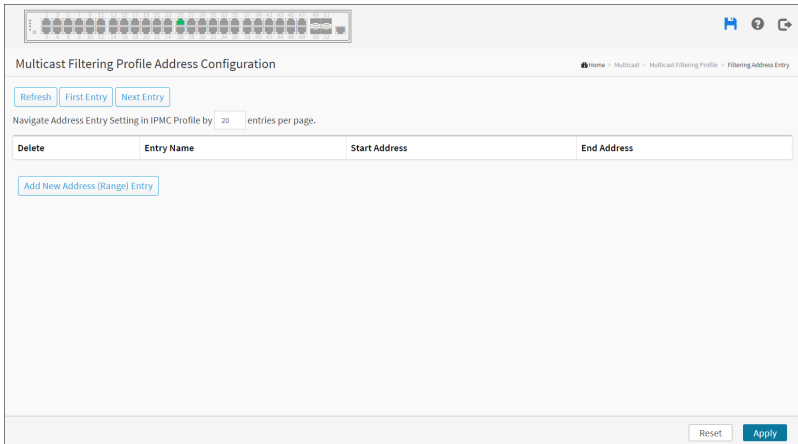

Web Interface

To configure the IPMC Profile Address Configuration in the web interface:

1. Click Multicast, Multicast Filtering Profile and Filtering Address Entry.
2. Click “Add New Address (Range) Entry”.

3. Specify Entry Name, Start Address and End Address.
4. Click the apply to save the setting.
5. If you want to cancel the setting then you need to click the Reset button. It will revert to previously saved values.
6. Click “Refresh” to refresh an entry of the MLD Snooping Group Information.
7. Click First Entry/Next Entry to change Entry.

■ Parameter description:

Entry Name:

The name used for indexing the address entry table.

Each entry has the unique name which is composed of at maximum 16 alphabetic and numeric characters.

Start Address:

The starting IPv4/IPv6 Multicast Group Address that will be used as an address range.

End Address:

The ending IPv4/IPv6 Multicast Group Address that will be used as an address range.

■ Buttons

Add New Address (Range) Entry:

Click to add new address range. Specify the name and configure the addresses. Click “Apply”

Delete:

Check to delete the entry.

The designated entry will be deleted during the next save.

Apply:

Click to save changes.

Reset:

Click to undo any changes made locally and revert to previously saved values.

First Entry:

Updates the table starting from the first entry in the IPMC Profile Address Configuration.

Next Entry:

Updates the table, starting with the entry after the last entry currently displayed.

Chapter 11

DHCP

Overview

The section describes to configure and display the DHCP Snooping parameters of the switch. The DHCP Snooping can prevent attackers from adding their own DHCP servers to the network.

The menu and the submenu are shown below:

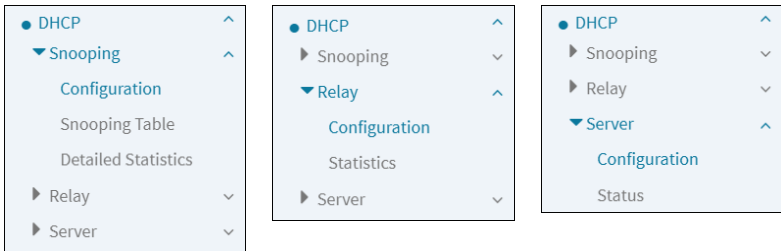

Snooping

Configuration

DHCP Snooping is used to block intruder on the untrusted ports of the switch device when it tries to intervene by injecting a bogus DHCP reply packet to a legitimate conversation between the DHCP client and server.

The section describes to configure the DHCP Snooping parameters of the switch. The DHCP Snooping can prevent attackers from adding their own DHCP servers to the network.

DHCP Snooping Configuration

Snooping Mode: Off

Port Mode Configuration

Port	Mode
*	<-
1	Trusted
2	Trusted
3	Trusted
4	Trusted
5	Trusted
6	Trusted
7	Trusted

Reset Apply

Web Interface

To configure DHCP snooping in the web interface:

1. Click DHCP, Snooping and Configuration.
2. Select “on” in the Mode of DHCP Snooping Configuration.
3. Select “Trusted” of the specific port in the Mode of Port Mode Configuration.
4. Click Apply.

■ Parameter description:

Snooping Mode:

Indicates the DHCP snooping mode operation. Possible modes are:

on: Enable DHCP snooping mode operation. When DHCP snooping mode operation is enabled, the DHCP request messages will be forwarded to trusted ports and only allow reply packets from trusted ports.

off: Disable DHCP snooping mode operation.

Port Mode Configuration:

Indicates the DHCP snooping port mode. Possible port modes are:

Trusted: Configures the port as trusted source of the DHCP messages. Trusted port can forward DHCP packets normally.

Untrusted: Configures the port as untrusted source of the DHCP messages.

Untrusted port will discard the packets when it receive DHCP packets.

■ Buttons

Apply:

Click to save changes.

Reset:

Click to undo any changes made locally and revert to previously saved values.

Snooping Table

This page display the dynamic IP assigned information after DHCP Snooping mode is enabled. All DHCP clients obtained the dynamic IP address from the DHCP server will be listed in this table except for local VLAN interface IP addresses. Entries in the Dynamic DHCP snooping Table are shown on this page.

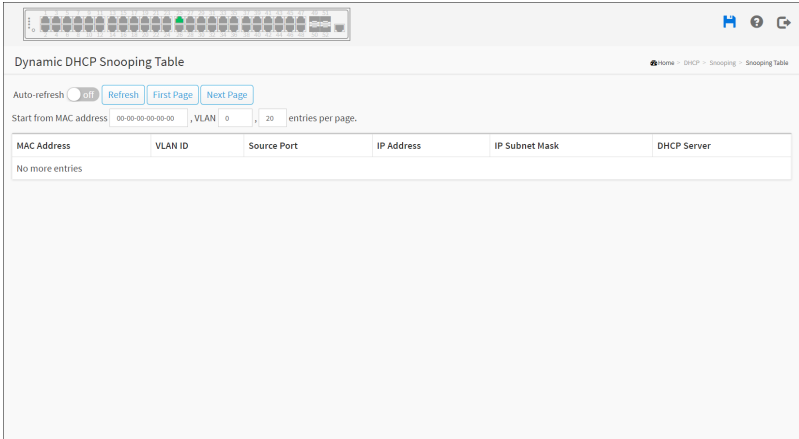

Dynamic DHCP Snooping Table

Auto-refresh Refresh First Page Next Page

Start from MAC address 00-00-00-00-00-00, VLAN 0, 20 entries per page.

MAC Address	VLAN ID	Source Port	IP Address	IP Subnet Mask	DHCP Server
No more entries					

Web Interface

To monitor a DHCP in the web interface:

1. Click DHCP, Snooping and Snooping table.
2. If you want to auto-refresh the information then you need to evoke the “Auto-refresh”.
3. To click the “Refresh” to refresh an entry of the MVR Groups Information.
4. Click First/Next Page to change page.

■ Parameter description:

Show entries:

You can choose how many items you want to show up.

MAC Address:

User MAC address of the entry.

VLAN ID:

VLAN-ID in which the DHCP traffic is permitted.

Source Port:

Switch Port Number for which the entries are displayed.

IP Address:

User IP address of the entry.

IP Subnet Mask:

User IP subnet mask of the entry.

DHCP Server:

DHCP Server address of the entry.

■ Buttons



Auto-refresh:

Check this box to refresh the page automatically. Automatic refresh occurs every 3 seconds.

Refresh:

Click to refresh the page.

First Page:

Updates the system log entries, turn to the first page.

Next Page:

Updates the group information entries, turn to the next page.

Detailed Statistics

This page provides statistics for DHCP snooping. Notice that the normal forward per-port TX statistics isn't increased if the incoming DHCP packet is done by L3 forwarding mechanism. And clear the statistics on specific port may not take effect on global statistics since it gathers the different layer overview.

DHCP Detailed Statistics Port 1

Auto-refresh Refresh Clear Combined Port 1

Receive Packets		Transmit Packets	
Rx Discover	0	Tx Discover	0
Rx Offer	0	Tx Offer	0
Rx Request	0	Tx Request	0
Rx Decline	0	Tx Decline	0
Rx ACK	0	Tx ACK	0
Rx NAK	0	Tx NAK	0
Rx Release	0	Tx Release	0
Rx Inform	0	Tx Inform	0
Rx Lease Query	0	Tx Lease Query	0
Rx Lease Unassigned	0	Tx Lease Unassigned	0
Rx Lease Unknown	0	Tx Lease Unknown	0
Rx Lease Active	0	Tx Lease Active	0
Rx Discarded Checksum Error	0		
Rx Discarded from Untrusted	0		

Web Interface

To display a DHCP Relay statistics in the web interface:

1. Click DHCP, Snooping and Detailed Statistics.
2. Select port that you want to display the DHCP Detailed Statistics.
3. If you want to auto-refresh the information then you need to evoke the “Auto-refresh”.
4. To click the “Refresh” to refresh an entry of the DHCP Detailed Statistics.

■ **Parameter description:**

Server Statistics

Rx and Tx Discover:

The number of discover (option 53 with value 1) packets received and transmitted.

Rx and Tx Offer:

The number of offer (option 53 with value 2) packets received and transmitted.

Rx and Tx Request:

The number of request (option 53 with value 3) packets received and transmitted.

Rx and Tx Decline:

The number of decline (option 53 with value 4) packets received and transmitted.

Rx and Tx ACK:

The number of ACK (option 53 with value 5) packets received and transmitted.

Rx and Tx NAK:

The number of NAK (option 53 with value 6) packets received and transmitted.

Rx and Tx Release:

The number of release (option 53 with value 7) packets received and transmitted.

Rx and Tx Inform:

The number of inform (option 53 with value 8) packets received and transmitted.

Rx and Tx Lease Query:

The number of lease query (option 53 with value 10) packets received and transmitted.

Rx and Tx Lease Unassigned:

The number of lease unassigned (option 53 with value 11) packets received and transmitted.

Rx and Tx Lease Unknown:

The number of lease unknown (option 53 with value 12) packets received and transmitted. Rx and Tx Lease Active

Rx and Tx Lease Active:

The number of lease active (option 53 with value 13) packets received and transmitted.

Rx Discarded checksum error:

The number of discard packet that IP/UDP checksum is error.

Rx Discarded from Untrusted:

The number of discarded packet that are coming from untrusted port.

■ Buttons



Auto-refresh off

Auto-refresh:

Check this box to refresh the page automatically. Automatic refresh occurs every 3 seconds.

Refresh:

Click to refresh the page immediately.

Port 1:

Select port that you want to display the DHCP Detailed Statistics.

Relay

Configuration

A DHCP relay agent is used to forward and to transfer DHCP messages between the clients and the server when they are not in the same subnet domain. It stores the incoming interface IP address in the GIADDR field of the DHCP packet. The DHCP server can use the value of GIADDR field to determine the assigned subnet. For such condition, please make sure the switch configuration of VLAN interface IP address and PVID (Port VLAN ID) correctly.

Relay Mode	<input type="checkbox"/> Off
Relay Server	0.0.0.0
Relay Information Mode	Disabled
Relay Information Policy	Keep

Web Interface

To configure DHCP Relay in the web interface:

1. Click DHCP, Relay and Configuration.
2. Specify the Relay Mode, Relay server, Relay Information Mode, Relay Information Policy.
3. Click Apply.

■ Parameter description:

Relay Mode:

Indicates the DHCP relay mode operation.

Possible modes are:

on: Enable DHCP relay mode operation. When DHCP relay mode operation is enabled, the agent forwards and transfers DHCP messages between the clients and the server when they are not in the same subnet domain. And the DHCP broadcast message won't be flooded for security considerations.

off: Disable DHCP relay mode operation.

Relay Server:

Indicates the DHCP relay server IP address.

Relay Information Mode:

Indicates the DHCP relay information mode option operation. The option 82 circuit ID format as “[vlan_id][module_id][port_no]”. The first four characters represent the VLAN ID, the fifth and sixth characters are the module ID (in standalone device it always equal 0, in stackable device it means switch ID), and the last two characters are the port number. For example, “00030108” means the DHCP message receive from VLAN ID 3, switch ID 1, port No 8. And the option 82 remote ID value is equal the switch MAC address.

Possible modes are:

Enabled: Enable DHCP relay information mode operation. When DHCP relay information mode operation is enabled, the agent inserts specific information (option 82) into a DHCP message when forwarding to DHCP server and removes it from a DHCP message when transferring to DHCP client. It only works when DHCP relay operation mode is enabled.

Disabled: Disable DHCP relay information mode operation.

Relay Information Policy:

Indicates the DHCP relay information option policy. When DHCP relay information mode operation is enabled, if the agent receives a DHCP message that already contains relay agent information it will enforce the policy. The 'Replace' policy is invalid when relay information mode is disabled. Possible policies are:

Replace: Replace the original relay information when a DHCP message that already contains it is received.

Keep: Keep the original relay information when a DHCP message that already contains it is received.

Drop: Drop the package when a DHCP message that already contains relay information is received.

■ Buttons

Apply:

Click to save changes.

Reset:

Click to undo any changes made locally and revert to previously saved values.

Statistics

This page provides statistics for DHCP relay.

DHCP Relay Statistics

Auto-refresh off

Server Statistics

Transmit to Server	0
Transmit Error	0
Receive from Server	0
Receive Missing Agent Option	0
Receive Missing Circuit ID	0
Receive Missing Remote ID	0
Receive Bad Circuit ID	0
Receive Bad Remote ID	0

Client Statistics

Transmit to Client	0
Transmit Error	0
Receive from Client	0
Receive Agent Option	0
Replace Agent Option	0
Keep Agent Option	0
Drop Agent Option	0

Web Interface

To monitor a DHCP Relay statistics in the web interface:

1. Click DHCP, Relay and Statistics.
2. To display DHCP relay statistics.
3. If you want to auto-refresh the information then you need to evoke the “Auto-refresh”.
4. To click the “Refresh” to refresh an entry of the DHCP Detailed Statistics.

■ Parameter description:**Server Statistics**

Transmit to Server:

The number of packets that are relayed from client to server.

Transmit Error:

The number of packets that resulted in errors while being sent to clients.

Receive from Server:

The number of packets received from server.

Receive Missing Agent Option:

The number of packets received without agent information options.

Receive Missing Circuit ID:

The number of packets received with the Circuit ID option missing.

Receive Missing Remote ID:

The number of packets received with the Remote ID option missing.

Receive Bad Circuit ID:

The number of packets whose Circuit ID option did not match known circuit ID.

Receive Bad Remote ID:

The number of packets whose Remote ID option did not match known Remote ID.

Client Statistics

Transmit to Client:

The number of relayed packets from server to client.

Transmit Error:

The number of packets that resulted in error while being sent to servers.

Receive from Client:

The number of received packets from server.

Receive Agent Option:

The number of received packets with relay agent information option.

Replace Agent Option:

The number of packets which were replaced with relay agent information option.

Keep Agent Option:

The number of packets whose relay agent information was retained.

Drop Agent Option:

The number of packets that were dropped which were received with relay agent information.

■ Buttons

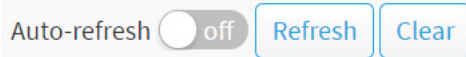

Auto-refresh:

Check this box to refresh the page automatically. Automatic refresh occurs every 3 seconds.

Refresh:

Click to refresh the page.

Clear:

Click to clear the page.

Server

Configuration

This page configures mode to enable/disable DHCP server per system and per VLAN. And configures Start IP and End IP addresses. DHCP server will allocate these IP addresses to DHCP client. And deliver configuration parameters to DHCP client.

VLAN	Mode	Start IP	End IP	Lease Time	Subnet Mask	Default Router	DNS Server
1	<input type="checkbox"/>			86400			

Web Interface

To configure DHCP server Configuration in the web interface:

1. Click DHCP, Server and Configuration.
2. Click “Add Interface”.
3. Specify VLAN, Mode, Start IP, End IP, Lease time, Subnet mask, Default router, DNS server.
4. Click Apply.

■ Parameter description:

VLAN:

Configure the VLAN in which DHCP server is enabled or disabled. Allowed VLAN are in the range 1 through 4095

Mode:

Indicate the operation mode per VLAN. Possible modes are:

Enable: Enable DHCP server per VLAN.

Disable: Disable DHCP server per VLAN.

Start IP and End IP:

Define the IP range. The Start IP must be smaller than or equal to the End IP.

Lease Time:

Display lease time of the pool.

Subnet Mask:

Configure subnet mask of the DHCP address.

Default router:

Configure the destination IP network or host address of this route.

DNS

Server:

Specify DNS server.

■ Buttons

Delete:

Check to delete the entry. It will be deleted during the next save.

Add Interface:

Click to add a new DHCP server.

Apply:

Click to save changes.

Reset:

Click to undo any changes made locally and revert to previously saved values.

Status

This page displays DHCP server status.

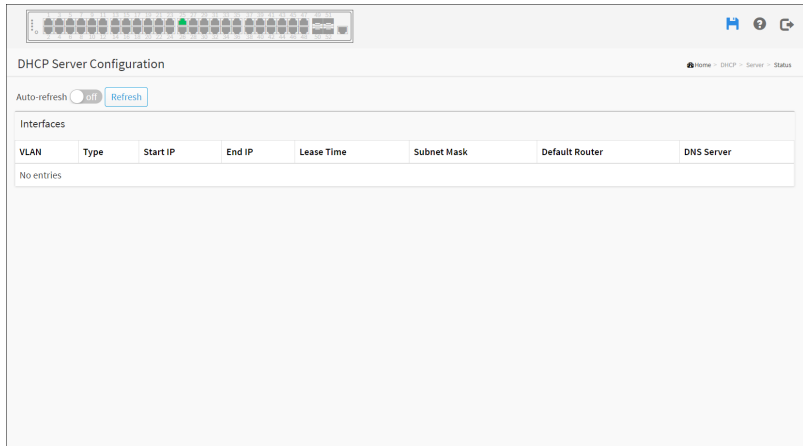

Web Interface

To display DHCP server status in the web interface:

1. Click DHCP, Server and Status.
2. If you want to auto-refresh the information then you need to evoke the “Auto-refresh”.
3. To click the “Refresh” to refresh an entry of the DHCP server status.

■ Parameter description:

VLAN:

The VLAN ID of the entry.

Type:

Indicate the operation type per VLAN. Possible types are: Static and DMS.

Start IP and End IP:

Display the Start IP and the End IP.

Lease Time:

Display lease time of the pool.

Subnet Mask:

Display subnet mask of the DHCP address.

Default router:

Display the destination IP network or host address of this route.

DNS

Server:

Display DNS server.

■ Buttons



Auto-refresh:

Check this box to refresh the page automatically. Automatic refresh occurs every 3 seconds.

Refresh:

Click to refresh the page immediately.

Overview

This section shows you to configure the Port Security settings of the Switch. You can use the Port Security feature to restrict input to an interface by limiting and identifying MAC addresses.

The menu and the submenu are shown below:

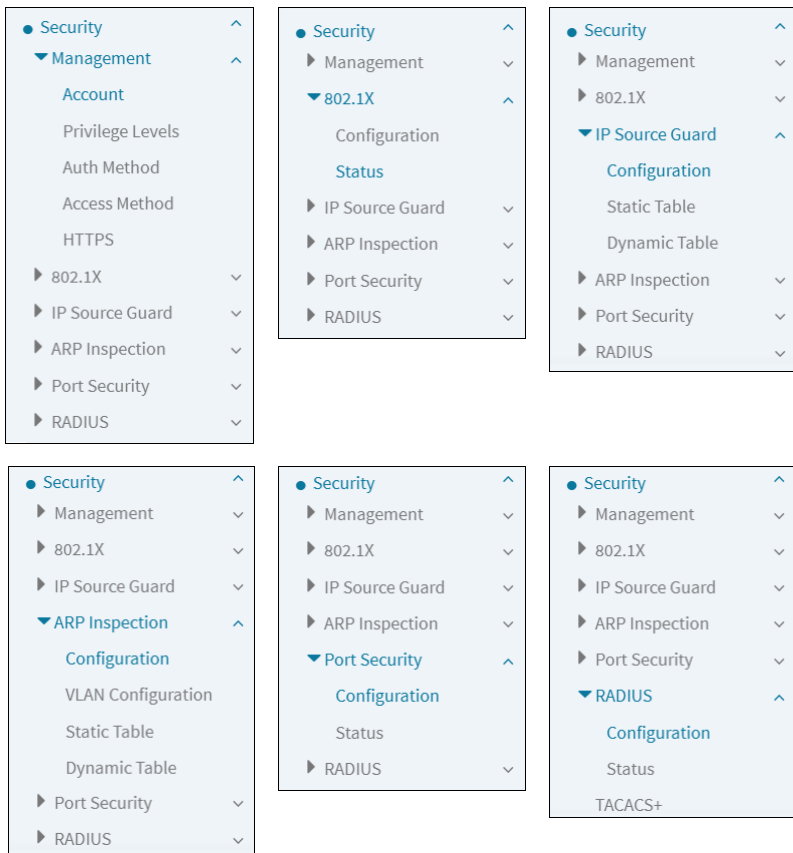

Management

Account

This page provides an overview of the current users. Currently the only way to login as another user on the web server is to close and reopen the browser

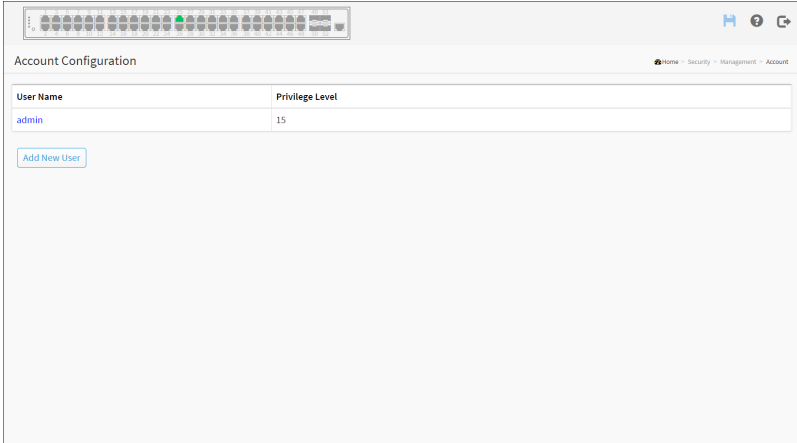

Web Interface

To configure User in the web interface:

1. Click Security, Management and Account.
2. Click Add new user.

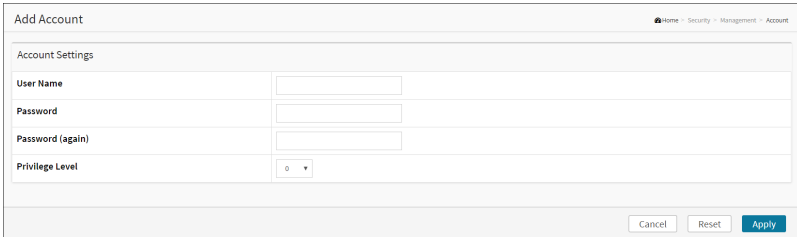

3. Specify the User Name parameter.
4. Click Apply.

■ Parameter description:

User Name:

The name identifying the user. The field can be input 31 characters. This is also a link to Add/Edit User.

Password:

To type the password. The field can be input 31 characters, and the allowed content is the ASCII characters from 32 to 126.

Password (again):

To type the password again. You must type the same password again in the field.

Privilege Level:

The privilege level of the user. The allowed range is 0 to 15. If the privilege level value is 15, it can access all groups, i.e. that is granted the fully control of the device. But others value need to refer to each group privilege level. User's privilege should be same or greater than the group privilege level to have the access of that group. By default setting, most groups privilege level 5 has the read-only access and privilege level 10 has the read-write access. And the system maintenance (software upload, factory defaults and etc.) need user privilege level 15. Generally, the privilege level 15 can be used for an administrator account, privilege level 10 for a standard user account and privilege level 5 for a guest account.

■ Buttons

Apply:

Click to save changes.

Reset:

Click to undo any changes made locally and revert to previously saved values.

Cancel:

Click to undo any changes made locally and return to the Users.

Delete User:

Delete the current user. This button is not available for new configurations (Add new user).

Privilege Levels

This page provides an overview of the privilege levels. The switch provides user set Account, Aggregation, Diagnostics, EEE, GARP, GVRP, IP, IPMC Snooping LACP LLDP LLDP MED MAC Table MRP MVR MVRP Maintenance Mirroring POE Ports Private VLANs QoS SMTP SNMP Security Spanning Tree System Trap Event VCL VLANs Voice VLAN Privilege Levels from 1 to 15.

Privilege Levels Configuration

Home Security Management Privilege Levels

Group Name	Privilege Levels	
	Read-only	Read-write
Aggregation	5	10
Debug	15	15
DHCP	5	10
DHCPv6_Client	5	10
Diagnostics	1	10
DMS_client	5	10
DMS_Trouble_Shooting	5	10
DMS_Vbatch	5	10
Firmware	5	10
FRR	5	10
Green_Ethernet	5	10
Install_Wizard	5	10
IP	5	10
IPMC_Snooping	5	10
LACP	5	10
LLDP	5	10
Loop_Protect	5	10
MAC_Table	5	10
Miscellaneous	1	10
MRP	5	10
MVR	5	10
NTP	5	10
POE	5	10
Ports	1	10
Private_VLANS	5	10
QoS	5	10
RMirror	5	10
Security(access)	5	10
Security(network)	5	10
sFlow	5	10
SMTp	5	10
Spanning_Tree	5	10
System	1	10
Trap_Event	5	10
UDLD	5	10
uFDMA_AIL	5	10
uFDMA_CIL	5	10
UPnP	5	10
VCL	5	10
VLAN_Translation	5	10
VLANS	5	10
Voice_VLAN	5	10
Watchdog	5	10
XXRP	5	10

Reset Apply

Web Interface

To configure Privilege Level in the web interface:

1. Click Security, Management and Privilege Levels.
2. Specify the Privilege parameter.
3. Click Apply.

■ **Parameter description:**

Group Name:

The name identifying the privilege group. In most cases, a privilege level group consists of a single module (e.g. LACP, STP or QoS), but a few of them contains more than one. The following description defines these privilege level groups in details:

System: Contact, Name, Location, Timezone, Daylight Saving Time, Log.

Privilege Levels:

Every group has an authorization Privilege level for the following sub groups: configuration read-only, configuration/execute read-write. User Privilege should be same or greater than the authorization Privilege level to have the access to that group.

■ **Buttons**

Apply:

Click to save changes.

Reset:

Click to undo any changes made locally and revert to previously saved values.

Auth Method

This page shows how to configure a user with auth method when he logs into the switch via one of the management client interfaces.

Authentication Method Configuration

Home > Security > Management > Auth Method

Authentication Method

Client	Methods			Service Port
console	local	no	no	
telnet	local	no	no	23
ssh	local	no	no	22
http	local	no	no	80
https	no	no	no	443

Command Authorization Method

Client	Method	Cmd Lvl	Cfg Cmd
console	no	0	<input type="checkbox"/>
telnet	no	0	<input type="checkbox"/>
ssh	no	0	<input type="checkbox"/>

Accounting Method

Client	Method	Cmd Lvl	Exec
console	no		<input type="checkbox"/>
telnet	no		<input type="checkbox"/>
ssh	no		<input type="checkbox"/>

Reset Apply

Web Interface

To configure an Auth Method Configuration in the web interface:

1. Click Security, Management and Auth Method.
2. Specify the Client (console, telnet, ssh, web) which you want to monitor.
3. Specify the Methods (none, local, radius, tacacs), Service port, Cmd Lvl, Cfg Cmd, Fallback, Exec.
4. Click Apply.

■ Parameter description:

Authentication Method Configuration

Client:

The management client for which the configuration below applies.

Method:

Authentication Method can be set to one of the following values:

none: authentication is disabled and login is not possible.

local: use the local user database on the switch for authentication.

radius: use a remote RADIUS server for authentication.

tacacs: use a remote TACACS server for authentication.

Methods that involves remote servers are timed out if the remote servers are offline. In this case the next method is tried. Each method is tried from left to right and continues until a method either approves or rejects a user. If a remote server is used for primary authentication it is recommended to configure secondary authentication as 'local'. This will enable the management client to login via the local user database if none of the configured authentication servers are alive.

Service Port:

The TCP port for each client service. The valid port number is 1 ~ 65534.

HTTP Redirect:

Enable http Automatic Redirect.

Command Authorization Method Configuration

Client:

The management client for which the configuration below applies.

Method:

Authorization Method can be set to one of the following values:

none: authorization is disabled and login is not possible.

tacacs: use a remote TACACS+ server for authorization.

Cmd Lvl:

Runs authorization for all commands at the specified privilege level. Specific command level that should be authorized. Valid entries are 0 through 15.

Cfg Cmd:

Enable or disable the configure command.

Fallback:

The local database can act as a fallback method for several functions. This behavior is designed to help you prevent accidental lockout from the security appliance.

Accounting Method Configuration

Client:

The management client for which the configuration below applies.

Method:

Accounting Method can be set to one of the following values:

none: accounting is disabled and login is not possible.

tacacs: use a remote TACACS+ server for accounting.

Cmd Lvl:

Runs accounting for all commands at the specified privilege level. Specific command level that should be authorized. Valid entries are 0 through 15.

Exec:

Runs accounting to determine if the user is allowed to run an EXEC shell. This facility might return user profile information such as auto command information.

■ Buttons

Apply:

Click to save changes.

Reset:

Click to undo any changes made locally and revert to previously saved values.

Access Method

This section shows you to configure access management table of the Switch including HTTP/HTTPS, SNMP, and TELNET/SSH. You can manage the Switch over an Ethernet LAN, or over the Internet.

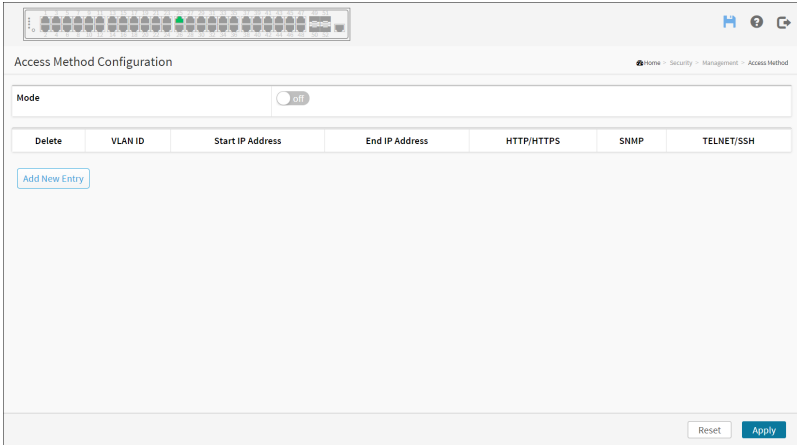

Web Interface

To configure an Access Method Configuration in the web interface:

1. Click Security, Management and Access Method.
2. Select “on” in the Mode of Access Management Configuration.
3. Click “Add new entry”.

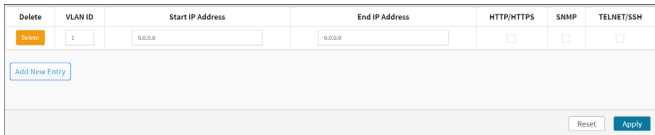

4. Specify the VLAN ID, Start IP Address, End IP Address.
5. Checked Access Management method (HTTP/HTTPS, SNMP, and TELNET/SSH) in the entry.
6. Click Apply.

■ Parameter description:

Mode:

Indicates the access management mode operation. Possible modes are:

On: Enable access management mode operation.

Off: Disable access management mode operation.

VLAN ID:

Indicates the VLAN ID for the access management entry.

Delete:

Check to delete the entry. It will be deleted during the next save.

Start IP address:

Indicates the start IP unicast address for the access management entry.

End IP address:

Indicates the end IP unicast address for the access management entry.

HTTP/HTTPS:

Indicates that the host can access the switch from HTTP/HTTPS interface if the host IP address matches the IP address range provided in the entry.

SNMP:

Indicates that the host can access the switch from SNMP interface if the host IP address matches the IP address range provided in the entry.

TELNET/SSH:

Indicates that the host can access the switch from TELNET/SSH interface if the host IP address matches the IP address range provided in the entry.

■ Buttons

Add New Entry:

Click to add a new access management entry.

Apply:

Click to save changes.

Reset:

Click to undo any changes made locally and revert to previously saved values.

HTTPS

This page allows you to configure the HTTPS settings and maintain the current certificate on the switch.

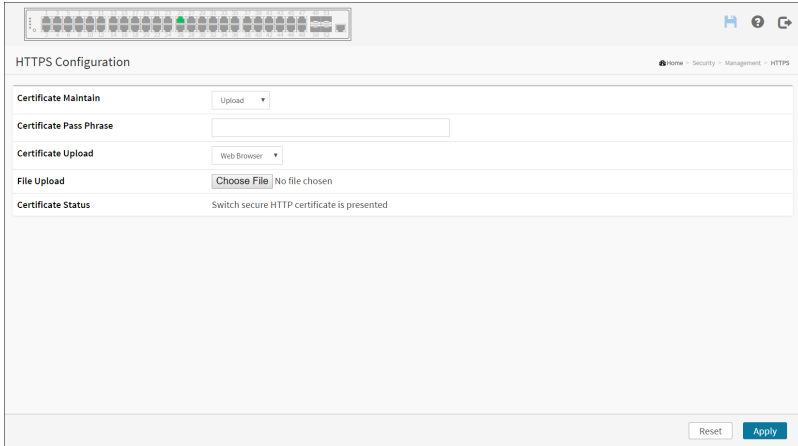

Web Interface

To configure an Access Management Configuration in the web interface:

1. Click Configuration, Security, Management and HTTPS.
2. Specify the Certificate Maintain, Certificate Pass Phrase, Certificate Upload.
3. Click Browser to select the file to upload.
4. Click Apply.

■ Parameter description:

Certificate Maintain:

The operation of certificate maintenance.

Possible operations are:

Upload: Upload a certificate PEM file. Possible methods are: Web Browser or URL.

Generate: Generate a new self-signed RSA certificate.

Certificate Pass Phrase:

Enter the pass phrase in this field if your uploading certificate is protected by a specific passphrase.

Certificate Upload:

Upload a certificate PEM file into the switch. The file should contain the certificate and private key together. If you have two separated files for saving certificate and private key. Use the Linux cat command to combine them into

a single PEM file. For example, `cat my.cert my.key > my.pem`

Notice that the RSA certificate is recommended since most of the new version of browsers has removed support for DSA in certificate, e.g. Firefox v37 and Chrome v39.

PossiXBFe methods are:

Web Browser: Upload a certificate via Web browser.

URL: Upload a certificate via URL, the supported protocols

are HTTP, HTTPS, TFTP and FTP. The URL format is `<protocol>://[<username>[:<password>]@]<host>[:<port>][/<path>]/<file_name>`. For example, `tftp://10.10.10.10/new_image_path/new_image.dat`, `http://username:password@10.10.10.10:80/new_image_path/new_image.dat`. A valid file name is a text string drawn from alphabet (A-Za-z), digits (0-9), dot (.), hyphen (-), under score (_). The maximum length is 63 and hyphen must not be first character. The file name content that only contains '!' is not allowed.

Certificate Status:

Display the current status of certificate on the switch.

PossiXBFe statuses are:

Switch secure HTTP certificate is presented.

Switch secure HTTP certificate is not presented.

Switch secure HTTP certificate is generating

■ Buttons

Apply:

Click to save changes.

Reset:

Click to undo any changes made locally and revert to previously saved values.

802.1X

Configuration

The section describes to configure the 802.1X parameters of the switch. The 802.1X can be employed to connect users to a variety of resources including Internet access, conference calls, printing documents on shared printers, or by simply logging on to the Internet.

802.1X Configuration

Home > Security > 802.1X > Configuration

[Refresh](#)

System Configuration

Mode	<input checked="" type="radio"/> Off
Reauthentication Enabled	<input type="checkbox"/>
Reauthentication Period	3600 seconds
EAPOL Timeout	30 seconds
Aging Period	300 seconds
Hold Time	10 seconds
RADIUS-Assigned QoS Enabled	<input type="checkbox"/>
RADIUS-Assigned VLAN Enabled	<input type="checkbox"/>
Guest VLAN Enabled	<input type="checkbox"/>
Guest VLAN ID	1
Max. Reauth. Count	2
Allow Guest VLAN If EAPOL Seen	<input type="checkbox"/>

Port Configuration

Port	Admin State	RADIUS-Assigned QoS Enabled	RADIUS-Assigned VLAN Enabled	Guest VLAN Enabled	Port State	Restart
*	<->	<input type="checkbox"/>	<input type="checkbox"/>	<input type="checkbox"/>		
1	Force Authorized	<input type="checkbox"/>	<input type="checkbox"/>	<input type="checkbox"/>	Globally Disabled	Reauthenticate Reinitialize
2	Force Authorized	<input type="checkbox"/>	<input type="checkbox"/>	<input type="checkbox"/>	Globally Disabled	Reauthenticate Reinitialize
3	Force Authorized	<input type="checkbox"/>	<input type="checkbox"/>	<input type="checkbox"/>	Globally Disabled	Reauthenticate Reinitialize
4	Force Authorized	<input type="checkbox"/>	<input type="checkbox"/>	<input type="checkbox"/>	Globally Disabled	Reauthenticate Reinitialize
5	Force Authorized	<input type="checkbox"/>	<input type="checkbox"/>	<input type="checkbox"/>	Globally Disabled	Reauthenticate Reinitialize

[Reset](#) [Apply](#)

Web Interface

To configure the IEEE 802.1X in the web interface:

1. Click Security, 802.1X and Configuration.
2. Select “on” in the Mode of IEEE 802.1X Configuration.
3. Checked Reauthentication Enabled.
4. Set Reauthentication Period (Default is 3600 seconds).

5. Set EAPOL Timeout (Default is 30 seconds).
6. Set Aging Period (Default is 300 seconds).
7. Set Hold Time (Default is 10 seconds).
8. Checked RADIUS-Assigned QoS Enabled.
9. Checked RADIUS-Assigned VLAN Enabled.
10. Checked Guest VLAN Enabled.
11. Specify Guest VLAN ID.
12. Specify Max. Reauth. Count.
13. Checked Allow Guest VLAN if EAPOL Seen.
14. Select Admin State and displays Port State.
15. Click the Apply to save the setting.
16. If you want to cancel the setting then you need to click the Reset button. It will revert to previously saved values.

■ **Parameter description:**

System Configuration

Mode:

on or off.

Indicates if IEEE 802.1X is globally enabled or disabled on the switch. If globally disabled, all ports are allowed forwarding of frames.

Reauthentication Enabled:

If checked, successfully authenticated supplicants/clients are reauthenticated after the interval specified by the Reauthentication Period. Reauthentication for 802.1X-enabled ports can be used to detect if a new device is plugged into a switch port or if a supplicant is no longer attached.

For MAC-based ports, reauthentication is only useful if the RADIUS server configuration has changed. It does not involve communication between the switch and the client, and therefore doesn't imply that a client is still present on a port (see Aging Period below).

Reauthentication Period:

Determines the period, in seconds, after which a connected client must be reauthenticated. This is only active if the Reauthentication Enabled checkbox is checked. Valid values are in the range 1 to 3600 seconds.

EAPOL Timeout:

Determines the time for retransmission of Request Identity EAPOL frames.

Valid values are in the range 1 to 65535 seconds. This has no effect for MAC-based ports.

Aging Period:

This setting applies to the following modes, i.e. modes using the Port Security functionality to secure MAC addresses:

- Single 802.1X
- Multi 802.1X
- MAC-Based Auth.

When the NAS module uses the Port Security module to secure MAC addresses, the Port Security module needs to check for activity on the MAC address in question at regular intervals and free resources if no activity is seen within a given period of time. This parameter controls exactly this period and can be set to a number between 10 and 1000000 seconds.

If reauthentication is enabled and the port is in an 802.1X-based mode, this is not so critical, since supplicants that are no longer attached to the port will get removed upon the next reauthentication, which will fail. But if reauthentication is not enabled, the only way to free resources is by aging the entries.

For ports in MAC-based Auth. mode, reauthentication doesn't cause direct communication between the switch and the client, so this will not detect whether the client is still attached or not, and the only way to free any resources is to age the entry.

Hold Time:

This setting applies to the following modes, i.e. modes using the Port Security functionality to secure MAC addresses:

- Single 802.1X
- Multi 802.1X
- MAC-Based Auth.

If a client is denied access - either because the RADIUS server denies the client access or because the RADIUS server request times out (according to the timeout specified on the "Configuration→Security→AAA" page) - the client is put on hold in the Unauthorized state. The hold timer does not count during an on-going authentication.

In MAC-based Auth. mode, the switch will ignore new frames coming from the client during the hold time.

The Hold Time can be set to a number between 10 and 1000000 seconds.

RADIUS-Assigned QoS Enabled:

RADIUS-assigned QoS provides a means to centrally control the traffic class to which traffic coming from a successfully authenticated supplicant is assigned on the switch. The RADIUS server must be configured to transmit special RADIUS attributes to take advantage of this feature (see RADIUS-Assigned QoS Enabled below for a detailed description).

The “RADIUS-Assigned QoS Enabled” checkbox provides a quick way to globally enable/disable RADIUS-server assigned QoS Class functionality. When checked, the individual ports' ditto setting determine whether RADIUS-assigned QoS Class is enabled on that port. When unchecked, RADIUS-server assigned QoS Class is disabled on all ports.

RADIUS-Assigned VLAN Enabled:

RADIUS-assigned VLAN provides a means to centrally control the VLAN on which a successfully authenticated supplicant is placed on the switch. Incoming traffic will be classified to and switched on the RADIUS-assigned VLAN. The RADIUS server must be configured to transmit special RADIUS attributes to take advantage of this feature (see RADIUS-Assigned VLAN Enabled below for a detailed description).

The “RADIUS-Assigned VLAN Enabled” checkbox provides a quick way to globally enable/disable RADIUS-server assigned VLAN functionality. When checked, the individual ports' ditto setting determine whether RADIUS-assigned VLAN is enabled on that port. When unchecked, RADIUS-server assigned VLAN is disabled on all ports.

Guest VLAN Enabled:

A Guest VLAN is a special VLAN - typically with limited network access - on which 802.1X-unaware clients are placed after a network administrator-defined timeout. The switch follows a set of rules for entering and leaving the Guest VLAN as listed below.

The “Guest VLAN Enabled” checkbox provides a quick way to globally enable/disable Guest VLAN functionality. When checked, the individual ports' ditto setting determines whether the port can be moved into Guest VLAN. When unchecked, the ability to move to the Guest VLAN is disabled on all ports.

Guest VLAN ID:

This is the value that a port's Port VLAN ID is set to if a port is moved into the Guest VLAN. It is only changeable if the Guest VLAN option is globally enabled.

Valid values are in the range [1; 4094].

Max. Reauth. Count:

The number of times the switch transmits an EAPOL Request Identity frame without response before considering entering the Guest VLAN is adjusted with this setting. The value can only be changed if the Guest VLAN option is globally enabled.

Valid values are in the range [1; 255].

Allow Guest VLAN if EAPOL Seen:

The switch remembers if an EAPOL frame has been received on the port for the life-time of the port. Once the switch considers whether to enter the Guest VLAN, it will first check if this option is enabled or disabled. If disabled (unchecked; default), the switch will only enter the Guest VLAN if an EAPOL frame has not been received on the port for the life-time of the port. If enabled (checked), the switch will consider entering the Guest VLAN even if an EAPOL frame has been received on the port for the life-time of the port. The value can only be changed if the Guest VLAN option is globally enabled.

Port Configuration

Port:

The port number for which the configuration below applies.

Admin State:

If 802.1X is globally enabled, this selection controls the port's authentication mode. The following modes are available:

- ◆ **Force Authorized:**

In this mode, the switch will send one EAPOL Success frame when the port link comes up, and any client on the port will be allowed network access without authentication.

- ◆ **Force Unauthorized:**

In this mode, the switch will send one EAPOL Failure frame when the port link comes up, and any client on the port will be disallowed network access.

- ◆ **Port-based 802.1X:**

In the 802.1X-world, the user is called the supplicant, the switch is the authenticator, and the RADIUS server is the authentication server. The authenticator acts as the man-in-the-middle, forwarding requests and responses between the supplicant and the authentication server. Frames sent between the supplicant and the switch are special 802.1X frames, known as EAPOL (EAP Over LANs) frames. EAPOL frames encapsulate EAP PDUs (RFC3748). Frames sent between the switch and the RADIUS server are RADIUS packets. RADIUS packets also encapsulate EAP

PDU's together with other attributes like the switch's IP address, name, and the supplicant's port number on the switch. EAP is very flexible, in that it allows for different authentication methods, like MD5-Challenge, PEAP, and TLS. The important thing is that the authenticator (the switch) doesn't need to know which authentication method the supplicant and the authentication server are using, or how many information exchange frames are needed for a particular method. The switch simply encapsulates the EAP part of the frame into the relevant type (EAPOL or RADIUS) and forwards it.

When authentication is complete, the RADIUS server sends a special packet containing a success or failure indication. Besides forwarding this decision to the supplicant, the switch uses it to open up or block traffic on the switch port connected to the supplicant

Note: Suppose two backend servers are enabled and that the server timeout is configured to X seconds (using the AAA configuration page), and suppose that the first server in the list is currently down (but not considered dead).

Now, if the supplicant retransmits EAPOL Start frames at a rate faster than X seconds, then it will never get authenticated, because the switch will cancel on-going backend authentication server requests whenever it receives a new EAPOL Start frame from the supplicant.

And since the server hasn't yet failed (because the X seconds haven't expired), the same server will be contacted upon the next backend authentication server request from the switch. This scenario will loop forever. Therefore, the server timeout should be smaller than the supplicant's EAPOL Start frame retransmission rate.

- ◆ Single 802.1X:

In port-based 802.1X authentication, once a supplicant is successfully authenticated on a port, the whole port is opened for network traffic. This allows other clients connected to the port (for instance through a hub) to piggy-back on the successfully authenticated client and get network access even though they really aren't authenticated. To overcome this security breach, use the Single 802.1X variant. Single 802.1X is really not an IEEE standard, but features many of the same characteristics as does port-based 802.1X. In Single 802.1X, at most one supplicant can get authenticated on the port at a time. Normal EAPOL frames are used in the communication between the supplicant and the switch. If more than one supplicant is connected to a port, the one that comes first when the port's link comes up will be the first one considered. If that supplicant doesn't provide valid

credentials within a certain amount of time, another supplicant will get a chance. Once a supplicant is successfully authenticated, only that supplicant will be allowed access. This is the most secure of all the supported modes. In this mode, the Port Security module is used to secure a supplicant's MAC address once successfully authenticated.

- ◆ Multi 802.1X:

In port-based 802.1X authentication, once a supplicant is successfully authenticated on a port, the whole port is opened for network traffic. This allows other clients connected to the port (for instance through a hub) to piggy-back on the successfully authenticated client and get network access even though they really aren't authenticated. To overcome this security breach, use the Multi 802.1X variant.

Multi 802.1X is really not an IEEE standard, but features many of the same characteristics as does port-based 802.1X. Multi 802.1X is - like Single 802.1X - not an IEEE standard, but a variant that features many of the same characteristics. In Multi 802.1X, one or more supplicants can get authenticated on the same port at the same time. Each supplicant is authenticated individually and secured in the MAC table using the Port Security module.

In Multi 802.1X it is not possible to use the multicast BPDU MAC address as destination MAC address for EAPOL frames sent from the switch towards the supplicant, since that would cause all supplicants attached to the port to reply to requests sent from the switch. Instead, the switch uses the supplicant's MAC address, which is obtained from the first EAPOL Start or EAPOL Response Identity frame sent by the supplicant. An exception to this is when no supplicants are attached. In this case, the switch sends EAPOL Request Identity frames using the BPDU multicast MAC address as destination - to wake up any supplicants that might be on the port.

The maximum number of supplicants that can be attached to a port can be limited using the Port Security Limit Control functionality.

- ◆ MAC-based Auth.:

Unlike port-based 802.1X, MAC-based authentication is not a standard, but merely a best-practices method adopted by the industry. In MAC-based authentication, users are called clients, and the switch acts as the supplicant on behalf of clients. The initial frame (any kind of frame) sent by a client is snooped by the switch, which in turn uses the client's MAC address as both username and password in the subsequent EAP exchange with the RADIUS server. The 6-byte MAC address is converted to a string

on the following form “xx-xx-xx-xx-xx-xx”, that is, a dash (-) is used as separator between the lower-cased hexadecimal digits. The switch only supports the MD5-Challenge authentication method, so the RADIUS server must be configured accordingly.

When authentication is complete, the RADIUS server sends a success or failure indication, which in turn causes the switch to open up or block traffic for that particular client, using the Port Security module. Only then will frames from the client be forwarded on the switch. There are no EAPOL frames involved in this authentication, and therefore, MAC-based Authentication has nothing to do with the 802.1X standard.

The advantage of MAC-based authentication over port-based 802.1X is that several clients can be connected to the same port (e.g. through a 3rd party switch or a hub) and still require individual authentication, and that the clients don't need special supplicant software to authenticate. The advantage of MAC-based authentication over 802.1X-based authentication is that the clients don't need special supplicant software to authenticate. The disadvantage is that MAC addresses can be spoofed by malicious users - equipment whose MAC address is a valid RADIUS user can be used by anyone. Also, only the MD5-Challenge method is supported. The maximum number of clients that can be attached to a port can be limited using the Port Security Limit Control functionality.

RADIUS-Assigned QoS Enabled:

When RADIUS-Assigned QoS is both globally enabled and enabled (checked) on a given port, the switch reacts to QoS Class information carried in the RADIUS Access-Accept packet transmitted by the RADIUS server when a supplicant is successfully authenticated. If present and valid, traffic received on the supplicant's port will be classified to the given QoS Class. If (re-)authentication fails or the RADIUS Access-Accept packet no longer carries a QoS Class or it's invalid, or the supplicant is otherwise no longer present on the port, the port's QoS Class is immediately reverted to the original QoS Class (which may be changed by the administrator in the meanwhile without affecting the RADIUS-assigned).

This option is only available for single-client modes, i.e.

- Port-based 802.1X
- Single 802.1X

RADIUS attributes used in identifying a QoS Class:

The User-Priority-Table attribute defined in RFC4675 forms the basis for identifying the QoS Class in an Access-Accept packet.

Only the first occurrence of the attribute in the packet will be considered, and

to be valid, it must follow this rule:

- All 8 octets in the attribute's value must be identical and consist of ASCII characters in the range '0' - '7', which translates into the desired QoS Class in the range [0; 7].

RADIUS-Assigned VLAN Enabled:

When RADIUS-Assigned VLAN is both globally enabled and enabled (checked) for a given port, the switch reacts to VLAN ID information carried in the RADIUS Access-Accept packet transmitted by the RADIUS server when a supplicant is successfully authenticated. If present and valid, the port's Port VLAN ID will be changed to this VLAN ID, the port will be set to be a member of that VLAN ID, and the port will be forced into VLAN unaware mode. Once assigned, all traffic arriving on the port will be classified and switched on the RADIUS-assigned VLAN ID.

If (re-)authentication fails or the RADIUS Access-Accept packet no longer carries a VLAN ID or it's invalid, or the supplicant is otherwise no longer present on the port, the port's VLAN ID is immediately reverted to the original VLAN ID (which may be changed by the administrator in the meanwhile without affecting the RADIUS-assigned).

This option is only available for single-client modes, i.e.

- Port-based 802.1X
- Single 802.1X

For trouble-shooting VLAN assignments, use the “Monitor→VLANs→VLAN Membership and VLAN Port” pages. These pages show which modules have (temporarily) overridden the current Port VLAN configuration.

RADIUS attributes used in identifying a VLAN ID:

RFC2868 and RFC3580 form the basis for the attributes used in identifying a VLAN ID in an Access-Accept packet. The following criteria are used:

- The Tunnel-Medium-Type, Tunnel-Type, and Tunnel-Private-Group-ID attributes must all be present at least once in the Access-Accept packet.
- The switch looks for the first set of these attributes that have the same Tag value and fulfil the following requirements (if Tag == 0 is used, the Tunnel-Private-Group-ID does not need to include a Tag):
 - Value of Tunnel-Medium-Type must be set to “IEEE-802” (ordinal 6).
 - Value of Tunnel-Type must be set to “VLAN” (ordinal 13).
 - Value of Tunnel-Private-Group-ID must be a string of ASCII chars in the range '0' - '9', which is interpreted as a decimal string representing the VLAN ID. Leading '0's are discarded. The final value must be in the range [1; 4095].

Guest VLAN Enabled:

When Guest VLAN is both globally enabled and enabled (checked) for a given port, the switch considers moving the port into the Guest VLAN according to the rules outlined below.

This option is only available for EAPOL-based modes, i.e.:

- Port-based 802.1X
- Single 802.1X
- Multi 802.1X

For trouble-shooting VLAN assignments, use the

“Monitor→VLANs→VLAN Membership and VLAN Port” pages. These pages show which modules have (temporarily) overridden the current Port VLAN configuration.

Guest VLAN Operation:

When a Guest VLAN enabled port's link comes up, the switch starts transmitting EAPOL Request Identity frames. If the number of transmissions of such frames exceeds Max. Reauth. Count and no EAPOL frames have been received in the meanwhile, the switch considers entering the Guest VLAN. The interval between transmission of EAPOL Request Identity frames is configured with EAPOL Timeout. If Allow Guest VLAN if EAPOL Seen is enabled, the port will now be placed in the Guest VLAN. If disabled, the switch will first check its history to see if an EAPOL frame has previously been received on the port (this history is cleared if the port link goes down or the port's Admin State is changed), and if not, the port will be placed in the Guest VLAN. Otherwise it will not move to the Guest VLAN, but continue transmitting EAPOL Request Identity frames at the rate given by EAPOL Timeout.

Once in the Guest VLAN, the port is considered authenticated, and all attached clients on the port are allowed access on this VLAN. The switch will not transmit an EAPOL Success frame when entering the Guest VLAN.

While in the Guest VLAN, the switch monitors the link for EAPOL frames, and if one such frame is received, the switch immediately takes the port out of the Guest VLAN and starts authenticating the supplicant according to the port mode. If an EAPOL frame is received, the port will never be able to go back into the Guest VLAN if the “Allow Guest VLAN if EAPOL Seen” is disabled.

Port State:

The current state of the port. It can undertake one of the following values:

Globally Disabled: IEEE 802.1X is globally disabled.

Link Down: IEEE 802.1X is globally enabled, but there is no link on the port.

Authorized: The port is in Force Authorized or a single-supPLICANT mode and the supplicant is authorized.

Unauthorized: The port is in Force Unauthorized or a single-supPLICANT mode and the supplicant is not successfully authorized by the RADIUS server.

X Auth/Y Unauth: The port is in a multi-supPLICANT mode. Currently X clients are authorized and Y are unauthorized.

Restart:

Two buttons are available for each row. The buttons are only enabled when authentication is globally enabled and the port's Admin State is in an EAPOL-based or MAC-based mode.

Clicking these buttons will not cause settings changed on the page to take effect.

Re-authenticate: Schedules a re-authentication whenever the quiet-period of the port runs out (EAPOL-based authentication). For MAC-based authentication, re-authentication will be attempted immediately.

The button only has effect for successfully authenticated clients on the port and will not cause the clients to get temporarily unauthorized.

Reinitialize: Forces a re-initialization of the clients on the port and thereby a re-authentication immediately. The clients will transfer to the unauthorized state while the re-authentication is in progress.

■ Buttons

Apply:

Click to save changes.

Reset:

Click to undo any changes made locally and revert to previously saved values.

Status

The section describes to show the each port 802.1X status information of the switch. The status includes Admin State, Port State, Last Source, Last ID and Port VLAN ID.

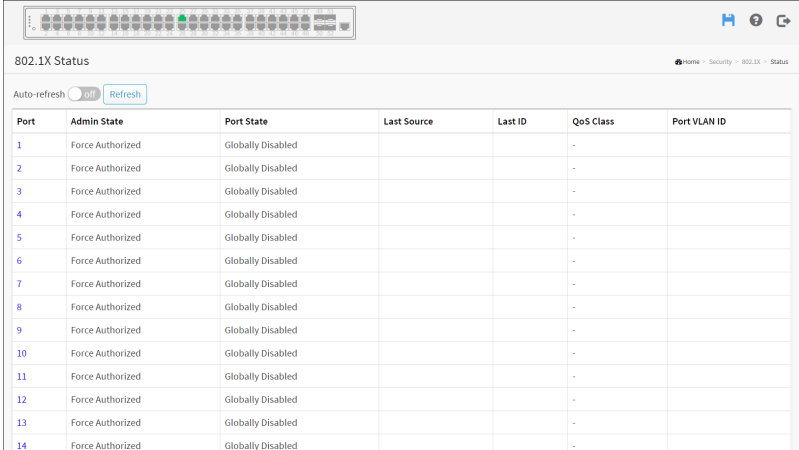

The screenshot shows the '802.1X Status' page in a web interface. At the top, there is a navigation bar with 'Home', 'Security', '802.1X', and 'Status'. Below the navigation bar, there is a table with 7 columns: Port, Admin State, Port State, Last Source, Last ID, QoS Class, and Port VLAN ID. The table contains 14 rows of data, all with 'Force Authorized' in the Admin State column and 'Globally Disabled' in the Port State column. The QoS Class column contains a '-' for all rows. The Last Source, Last ID, and Port VLAN ID columns are empty for all rows. There is an 'Auto-refresh' toggle set to 'off' and a 'Refresh' button.

Port	Admin State	Port State	Last Source	Last ID	QoS Class	Port VLAN ID
1	Force Authorized	Globally Disabled			-	
2	Force Authorized	Globally Disabled			-	
3	Force Authorized	Globally Disabled			-	
4	Force Authorized	Globally Disabled			-	
5	Force Authorized	Globally Disabled			-	
6	Force Authorized	Globally Disabled			-	
7	Force Authorized	Globally Disabled			-	
8	Force Authorized	Globally Disabled			-	
9	Force Authorized	Globally Disabled			-	
10	Force Authorized	Globally Disabled			-	
11	Force Authorized	Globally Disabled			-	
12	Force Authorized	Globally Disabled			-	
13	Force Authorized	Globally Disabled			-	
14	Force Authorized	Globally Disabled			-	

Web Interface

To displays 802.1X Status in the web interface:

1. Click Security, IEEE 802.1X and Status.
2. Checked “Auto-refresh”.
3. Click “Refresh” to refresh the port detailed statistics.
4. You can select which port that you want display 802.1X Statistics.

■ Parameter description:

802.1X Status

Port:

The switch port number. Click to navigate to detail 802.1X statistics for this port.

Admin State:

The port's current administrative state. Refer to 802.1X Admin State for a description of possible values.

Port State:

The current state of the port. Refer to 802.1X Port State for a description of the individual states.

Last Source:

The source MAC address carried in the most recently received EAPOL frame for EAPOL-based authentication, and the most recently received frame from a new client for MAC-based authentication.

Last ID:

The user name (supplicant identity) carried in the most recently received Response Identity EAPOL frame for EAPOL-based authentication, and the source MAC address from the most recently received frame from a new client for MAC-based authentication.

QoS Class:

QoS Class assigned to the port by the RADIUS server if enabled.

Port VLAN ID:

The VLAN ID that 802.1X has put the port in. The field is blank, if the Port VLAN ID is not overridden by 802.1X.

If the VLAN ID is assigned by the RADIUS server, "(RADIUS-assigned)" is appended to the VLAN ID. Read more about RADIUS-assigned VLANs [here](#).

If the port is moved to the Guest VLAN, "(Guest)" is appended to the VLAN ID. Read more about Guest VLANs [here](#).

■ Buttons

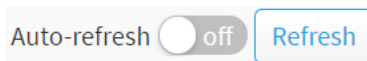

Auto-refresh:

Check this box to refresh the page automatically. Automatic refresh occurs every 3 seconds.

Refresh:

Click to refresh the page immediately.

Port 1-52 Status:

Click the port number to view the port status individually.

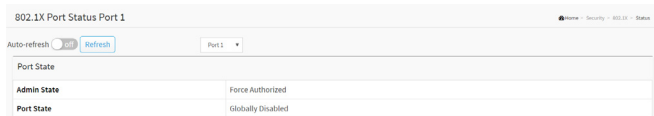

■ Parameter description:

Port:

Use the drop-down menu to select which port you wish to display.

Admin State:

The port's current administrative state. Refer to 802.1X Admin State for a description of possible values.

Port State:

The current state of the port. Refer to 802.1X Port State for a description of the individual states.

■ Buttons

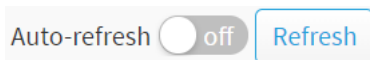

Auto-refresh:

Check this box to refresh the page automatically. Automatic refresh occurs every 3 seconds.

Refresh:

Click to refresh the page immediately.

IP Source Guard

The section describes to configure the IP Source Guard detail parameters of the switch. You could use the IP Source Guard configure to enable or disable with the Port of the switch.

Configuration

This section describes how to configure IP Source Guard setting including?

Mode (Enabled and Disabled)

Maximum Dynamic Clients (0, 1, 2, Unlimited)

IP Source Guard Configuration

Mode: Off

Port Mode Configuration

Port	Mode	Max Dynamic Clients
1	Disabled	Unlimited
2	Disabled	Unlimited
3	Disabled	Unlimited
4	Disabled	Unlimited
5	Disabled	Unlimited
6	Disabled	Unlimited
7	Disabled	Unlimited

Reset Apply

Web Interface

To configure an IP Source Guard Configuration in the web interface:

1. Click Security, IP Source Guard and Configuration.
2. Select “on” in the Mode of IP Source Guard Configuration.
3. Select “Enabled” of the specific port in the Mode of Port Mode Configuration.
4. Select Maximum Dynamic Clients (0, 1, 2, Unlimited) of the specific port in the Mode of Port Mode Configuration.
5. Click Apply.

■ Parameter description:

Mode of IP Source Guard Configuration :

Enable the Global IP Source Guard or disable the Global IP Source Guard. All configured ACEs will be lost when the mode is enabled.

Port Mode Configuration:

Specify IP Source Guard is enabled on which ports. Only when both Global Mode and Port Mode on a given port are enabled, IP Source Guard is enabled on this given port.

Max Dynamic Clients:

Specify the maximum number of dynamic clients that can be learned on given port. This value can be 0, 1, 2 or unlimited. If the port mode is enabled and the value of max dynamic client is equal to 0, it means only allow the IP packets forwarding that are matched in static entries on the specific port.

■ Buttons

Apply:

Click to save changes.

Reset:

Click to undo any changes made locally and revert to previously saved values.

Translate dynamic to static:

Click to translate all dynamic entries to static entries.

Static Table

The section describes to configure the Static IP Source Guard Table parameters of the switch. You could use the Static IP Source Guard Table configure to manage the entries.

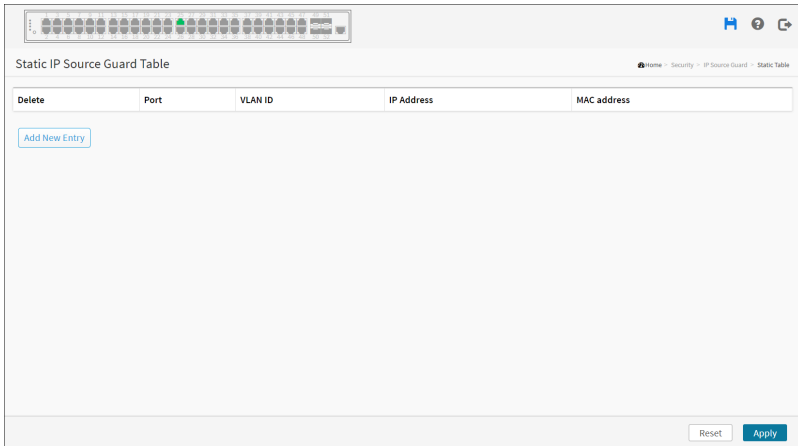

Web Interface

To configure a Static IP Source Guard Table Configuration in the web interface:

1. Click Security, IP Source Guard and Static Table.
2. Click “Add New Entry”.

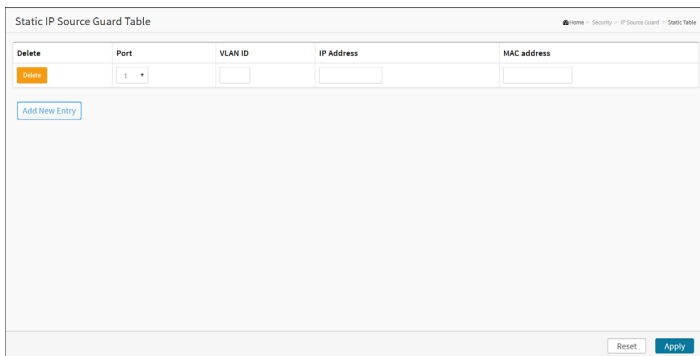

3. Specify the Port, VLAN ID, IP Address, and MAC address in the entry.
4. Click Apply.

■ Parameter description:

Port:

The logical port for the settings.

VLAN ID:

The vlan id for the settings.

IP Address:

Allowed Source IP address.

MAC address:

Allowed Source MAC address.

■ **Buttons**

Add New Entry:

Click to add a new entry to the Static IP Source Guard table. Specify the Port, IP address, and MAC address for the new entry. Click "Apply".

Delete:

Check to delete the entry. It will be deleted during the next save.

Apply:

Click to save changes.

Reset:

Click to undo any changes made locally and revert to previously saved values.

Dynamic Table

Entries in the Dynamic IP Source Guard Table are shown on this page. The Dynamic IP Source Guard Table is sorted first by port, then by IP address, and then by MAC address.

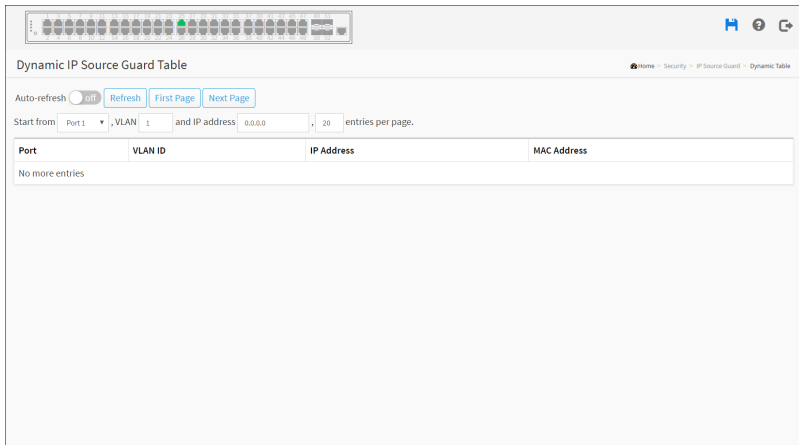

Web Interface

To configure a Dynamic IP Source Guard Table Configuration in the web interface:

1. Click Security, IP Source Guard and Dynamic Table.
2. Checked “Auto-refresh”.
3. Click “Refresh” to refresh the port detailed statistics.
4. Click First/Next Page to change page.
5. Specify the Start from port, VLAN, IP Address, and entries per page.

■ Parameter description:

Navigating the IP Source Guard Table

Each page shows up to 99 entries from the Dynamic IP Source Guard table, default being 20, selected through the “entries per page” input field. When first visited, the web page will show the first 20 entries from the beginning of the Dynamic IP Source Guard Table.

The “Start from port address”, “VLAN” and “IP address” input fields allow the user to select the starting point in the Dynamic IP Source Guard Table.

Clicking “Refresh” the button will update the displayed table starting from that or the closest next Dynamic IP Source Guard Table match. In addition, the two input fields will - upon a “Refresh” button click - assume the value of the first displayed entry, allowing for continuous refresh with the same start address. The “Next Page” will use the last entry of the currently displayed table as a

basis for the next lookup. When the end is reached the text “No more entries” is shown in the displayed table. Use the “First Page” button to start over.

Port:

Switch Port Number for which the entries are displayed.

VLAN ID:

VLAN-ID in which the IP traffic is permitted.

IP Address:

User IP address of the entry.

MAC Address:

Source MAC address.

Show entries:

You can choose how many items you want to show.

■ Buttons



Auto-refresh:

Check this box to refresh the page automatically. Automatic refresh occurs every 3 seconds.

Refresh:

Click to refresh the page.

First Page:

Updates the system log entries, turn to the first page.

Next Page:

Updates the group information entries, turn to the next page.

ARP Inspection

The section describes to configure the ARP Inspection parameters of the switch. You could use the ARP Inspection configure to manage the ARP table.

Configuration

This section describes how to configure ARP Inspection setting including:

Mode (on and off)

Port (Enabled and Disabled)

ARP Inspection Configuration

Mode: On Off

Port Mode Configuration

Port	Mode	Check VLAN	Log Type
1	Disabled	Disabled	None
2	Disabled	Disabled	None
3	Disabled	Disabled	None
4	Disabled	Disabled	None
5	Disabled	Disabled	None
6	Disabled	Disabled	None
7	Disabled	Disabled	None

Reset Apply

Web Interface

To configure an ARP Inspection Configuration in the web interface:

1. Click Security, ARP Inspection and Configuration.
2. Select “on” in the Mode of ARP Inspection Configuration.
3. Select “Enabled” of the specific port in the Mode of Port Mode Configuration.
4. Click Apply.

■ Parameter description:

Mode of ARP Inspection Configuration:

Enable the Global ARP Inspection or disable the Global ARP Inspection.

Port Mode Configuration:

Specify ARP Inspection is enabled on which ports. Only when both Global Mode and Port Mode on a given port are enabled, ARP Inspection is enabled on this given port. Possible modes are:

Enabled: Enable ARP Inspection operation.

Disabled: Disable ARP Inspection operation.

If you want to inspect the VLAN configuration, you have to enable the setting of “Check VLAN”. The default setting of “Check VLAN” is disabled. When the setting of “Check VLAN” is disabled, the log type of ARP Inspection will refer to the port setting. And the setting of “Check VLAN” is enabled, the log type of ARP Inspection will refer to the VLAN setting. Possible setting of “Check VLAN” are:

Enabled: Enable check VLAN operation.

Disabled: Disable check VLAN operation.

Only the Global Mode and Port Mode on a given port are enabled, and the setting of “Check VLAN” is disabled, the log type of ARP Inspection will refer to the port setting. There are four log types and possible types are:

None: Log nothing.

Deny: Log denied entries.

Permit: Log permitted entries.

ALL: Log all entries.

Check VLAN:

If you want to inspect the VLAN configuration, you have to enable the setting of “Check VLAN”. The default setting of “Check VLAN” is disabled. When the setting of “Check VLAN” is disabled, the log type of ARP Inspection will refer to the port setting. And the setting of “Check VLAN” is enabled, the log type of ARP Inspection will refer to the VLAN setting. Possible setting of “Check VLAN” are:

Enabled: Enable check VLAN operation.

Disabled: Disable check VLAN operation.

Log Type:

Only the Global Mode and Port Mode on a given port are enabled, and the setting of “Check VLAN” is disabled, the log type of ARP Inspection will refer to the port setting. There are four log types and possible types are:

None: Log nothing.

Deny: Log denied entries.

Permit: Log permitted entries.

ALL: Log all entries.

■ Buttons

Apply:

Click to save changes.

Reset:

Click to undo any changes made locally and revert to previously saved values.

Translate dynamic to static:

Click to translate all dynamic entries to static entries.

VLAN Configuration

Specify ARP Inspection is enabled on which VLANs.

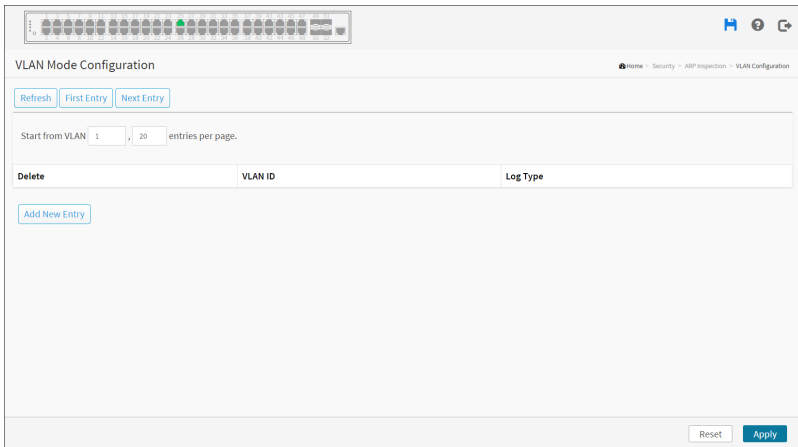

Web Interface

To configure a VLAN Mode Configuration in the web interface:

1. Click Security, ARP Inspection and VLAN Configuration.
2. Click “Add new entry”.

3. Specify the VLAN ID, Log Type.
4. Click Apply.
5. Click First Entry/Next Entry to change Entry.

■ Parameter description:

Navigating the VLAN Configuration

Each page shows up to 9999 entries from the VLAN table, default being 20, selected through the “entries per page” input field. When first visited, the web page will show the first 20 entries from the beginning of the VLAN Table. The first displayed will be the one with the lowest VLAN ID found in the VLAN Table.

The “VLAN” input fields allow the user to select the starting point in the VLAN Table. Clicking “Refresh” the button will update the displayed table starting from that or the closest next VLAN Table match. The “Next Entry” will use the next entry of the currently displayed VLAN entry as a basis for the next lookup. When the end is reached the warning message is shown in the displayed table. Use the “First Entry” button to start over.

VLAN Mode Configuration:

Specify ARP Inspection is enabled on which VLANs. First, you have to enable the port setting on Port mode configuration web page. Only when both Global Mode and Port Mode on a given port are enabled, ARP Inspection is enabled on this given port. Second, you can specify which VLAN will be inspected on VLAN mode configuration web page. The log type also can be configured on per VLAN setting.

Possible types are:

None: Log nothing.

Deny: Log denied entries.

Permit: Log permitted entries.

ALL: Log all entries.

■ Buttons

Add New Entry:

Click to add a new VLAN to the ARP Inspection VLAN table.

Delete:

Check to delete the entry. It will be deleted during the next save.

Apply:

Click to save changes.

Reset:

Click to undo any changes made locally and revert to previously saved values.

First Entry:

Updates the table starting from the first entry in the IPMC Profile Address Configuration.

Next Entry:

Updates the table, starting with the entry after the last entry currently displayed.

Refresh:

Click to refresh the page immediately.

Static Table

The section describes to configure the Static ARP Inspection Table parameters of the switch. You could use the Static ARP Inspection Table configure to manage the ARP entries.

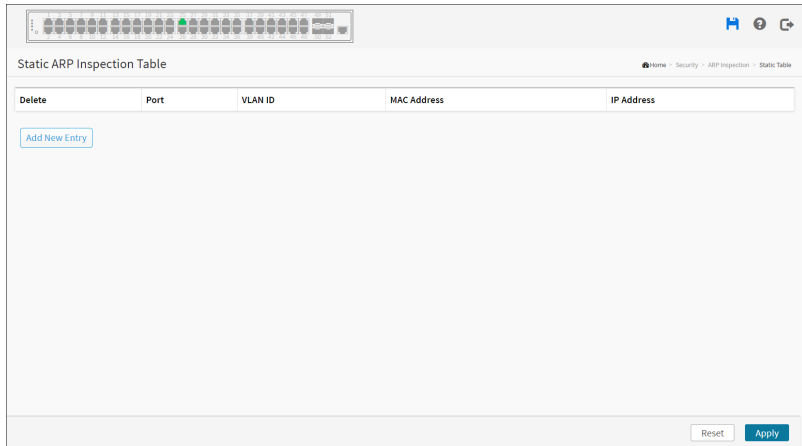

Web Interface

To configure a Static ARP Inspection Table Configuration in the web interface:

1. Click Security, ARP Inspection and Static Table.
2. Click “Add new entry”.

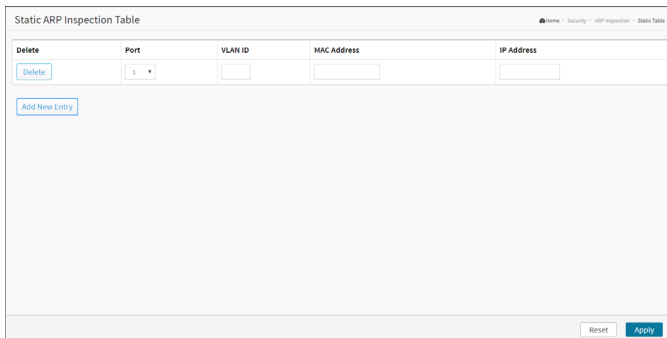

3. Specify the Port, VLAN ID, IP Address, MAC address and IP Address in the entry.
4. Click Apply.

■ Parameter description:

Port:

The logical port for the settings.

VLAN ID:

The vlan id for the settings.

MAC Address:

Allowed Source MAC address in ARP request packets.

IP Address:

Allowed Source IP address in ARP request packets.

■ Buttons

Add New Entry:

Click to add a new entry to the Static ARP Inspection table.

Delete:

Check to delete the entry. It will be deleted during the next save.

Apply:

Click to save changes.

Reset:

Click to undo any changes made locally and revert to previously saved values.

Dynamic Table

Entries in the Dynamic ARP Inspection Table are shown on this page. The Dynamic ARP Inspection Table contains up to 256 entries, and is sorted first by port, then by VLAN ID, then by MAC address, and then by IP address. All dynamic entries are learning from DHCP Snooping.

Navigating the ARP Inspection Table

Each page shows up to 99 entries from the Dynamic ARP Inspection table, default being 20, selected through the “entries per page” input field. When first visited, the web page will show the first 20 entries from the beginning of the Dynamic ARP Inspection Table.

The “Start from port address”, “VLAN”, “MAC address” and “IP address” input fields allow the user to select the starting point in the Dynamic ARP Inspection Table. Clicking the “Refresh” button will update the displayed table starting from that or the closest next Dynamic ARP Inspection Table match. In addition, the two input fields will - upon a “Refresh” button click - assume the value of the first displayed entry, allowing for continuous refresh with the same start address.

The “Next Page” will use the last entry of the currently displayed table as a basis for the next lookup. When the end is reached the text “No more entries” is shown in the displayed table. Use the “First Page” button to start over.

Dynamic ARP Inspection Table

Auto-refresh Refresh First Page Next Page

Start from Port: 1, VLAN: 1, MAC address: 00-00-00-00-00-00 and IP address: 0.0.0.0, 20 entries per page.

System Configuration

Port	VLAN ID	MAC Address	IP Address	Translate to static
No more entries				

Reset Apply

Web Interface

To configure a Dynamic ARP Inspection Table Configuration in the web interface:

1. Click Security, ARP Inspection and Dynamic Table.
2. Checked “Auto-refresh”.
3. Click “Refresh” to refresh the port detailed statistics.
4. Click First/Next Page to change page.
5. Specify the Start from port, VLAN, MAC Address, IP Address, and entries per page.

■ Parameter description:

ARP Inspection Table Columns

Port:

Switch Port Number for which the entries are displayed.

VLAN ID:

VLAN ID in which the ARP traffic is permitted.

MAC Address:

User MAC address of the entry.

IP Address:

User IP address of the entry.

Show entries:

You can choose how many items you want to show up.

■ Buttons



Auto-refresh:

Check this box to refresh the page automatically. Automatic refresh occurs every 3 seconds.

Refresh:

Click to refresh the page.

First Page:

Updates the system log entries, turn to the first page.

Next Page:

Updates the group information entries, turn to the next page.

Port Security

Configuration

This section shows you to configure the Port Security settings of the Switch. You can use the Port Security feature to restrict input to an interface by limiting and identifying MAC addresses.

Port Security Configuration

System Configuration

Aging Enabled

Aging Period seconds

Hold Time seconds

Port Configuration

Port	Mode	Limit	Violation Mode	Violation Limit	State	Re-open	Sticky	Clear
*	<>	4	<>	4			<>	
1	Disabled	4	Protect	4	Disabled	Reopen	Disabled	Clear
2	Disabled	4	Protect	4	Disabled	Reopen	Disabled	Clear
3	Disabled	4	Protect	4	Disabled	Reopen	Disabled	Clear

Reset Apply

Web Interface

To configure a Port Security Configuration in the web interface:

1. Click Security, Port Security and Configuration.
2. Click to Enable the Aging to specify Aging Period.
3. Set Mode (Enabled, Disabled), Limit, Violation Mode, Violation Limit for each port.
4. Click the Apply to save the setting.
5. If you want to cancel the setting then you need to click the Reset button. It will revert to previously saved values.

■ Parameter description:

System Configuration

Aging Enabled:

If checked, secured MAC addresses are subject to aging as discussed under Aging Period .

Aging Period:

If Aging Enabled is checked, then the aging period is controlled with this input. If other modules are using the underlying functionality for securing MAC addresses, they may have other requirements to the aging period. The underlying functionality will use the shorter requested aging period of all modules that have aging enabled.

The Aging Period can be set to a number between 10 and 10000000seconds with a default of 3600 seconds.

To understand why aging may be desired, consider the following scenario: Suppose an end-host is connected to a 3rd party switch or hub, which in turn is connected to a port on this switch on which Port Security is enabled. The end-host will be allowed to forward if the limit is not exceeded. Now suppose that the end-host logs off or powers down. If it wasn't for aging, the end-host would still take up resources on this switch and will be allowed to forward. To overcome this situation, enable aging. With aging enabled, a timer is started once the end-host gets secured. When the timer expires, the switch starts looking for frames from the end-host, and if such frames are not seen within the next Aging Period, the end-host is assumed to be disconnected, and the corresponding resources are freed on the switch.

Hold Time:

The hold time - measured in seconds - is used to determine how long a MAC address is held in the MAC table if it has been found to violate the limit. Valid range is between 10 and 10000000 seconds with a default of 300 seconds.

The reason for holding a violating MAC address in the MAC table is primarily to ensure that the same MAC address doesn't give rise to continuous notifications (if notifications on violation count is enabled).

Port Configuration

The table has one row for each port on the selected switch and a number of columns, which are:

Port:

The port number to which the configuration below applies.

Mode:

Controls whether Limit Control is enabled on this port. Both this and the Global Mode must be set to Enabled for Limit Control to be in effect. Notice that other modules may still use the underlying port security features without enabling Limit Control on a given port.

Limit:

The maximum number of MAC addresses that can be secured on this port. This number cannot exceed 1024. If the limit is exceeded, the corresponding action is taken.

The switch is “born” with a total number of MAC addresses from which all ports draw whenever a new MAC address is seen on a Port Security-enabled port. Since all ports draw from the same pool, it may happen that a configured maximum cannot be granted, if the remaining ports have already used all available MAC addresses.

Violation Mode:

If Limit is reached, the switch can take one of the following actions:

Protect: Do not allow more than Limit MAC addresses on the port, but take no further action.

Restrict: If Limit is reached, subsequent MAC addresses on the port will be counted and marked as violating. Such MAC addresses are removed from the MAC table when the hold time expires. At most Violation Limit MAC addresses can be marked as violating at any given time.

Shutdown: If Limit is reached, one additional MAC address will cause the port to be shut down. This implies that all secured MAC addresses be removed from the port, and no new addresses be learned. There are three ways to re-open the port:

- 1) In the “Configuration→Ports” page's “Configured” column, first disable the port, then restore the original mode.
- 2) Make a Port Security configuration change on the port.
- 3) Boot the switch.

Violation Limit

The maximum number of MAC addresses that can be marked as violating on this port. This number cannot exceed 1023. Default is 4. It is only used when Violation Mode is Restrict.

State:

This column shows the current state of the port as seen from the Limit Control's point of view. The state takes one of four values:

Disabled: Limit Control is either globally disabled or disabled on the port.

Ready: The limit is not yet reached. This can be shown for all actions.

Limit Reached: Indicates that the limit is reached on this port. This state can only be shown if Action is set to none or Trap.

Shutdown: Indicates that the port is shut down by the Limit Control module. This state can only be shown if Action is set to Shutdown or Trap & Shutdown.

■ Buttons

Apply:

Click to save changes.

Reset:

Click to undo any changes made locally and revert to previously saved values.

Status

This section shows the Port Security status. Port Security is a module with no direct configuration. Configuration comes indirectly from other modules - the user modules. When a user module has enabled port security on a port, the port is set-up for software-based learning. In this mode, frames from unknown MAC addresses are passed on to the port security module, which in turn asks all user modules whether to allow this new MAC address to forward or block it. For a MAC address to be set in the forwarding state, all enabled user modules must unanimously agree on allowing the MAC address to forward. If only one chooses to block it, it will be blocked until that user module decides otherwise. The status page is divided into two sections - one with a legend of user modules and one with the actual port status.

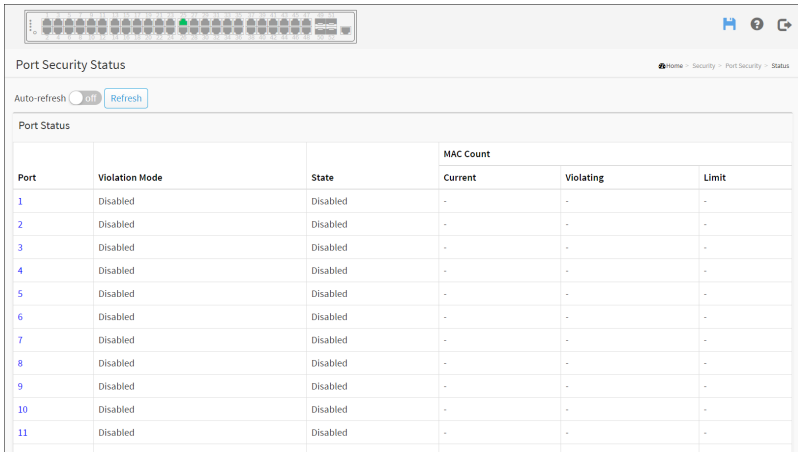

Port	Violation Mode	State	MAC Count		
			Current	Violating	Limit
1	Disabled	Disabled	-	-	-
2	Disabled	Disabled	-	-	-
3	Disabled	Disabled	-	-	-
4	Disabled	Disabled	-	-	-
5	Disabled	Disabled	-	-	-
6	Disabled	Disabled	-	-	-
7	Disabled	Disabled	-	-	-
8	Disabled	Disabled	-	-	-
9	Disabled	Disabled	-	-	-
10	Disabled	Disabled	-	-	-
11	Disabled	Disabled	-	-	-

Web Interface

To displays a Port Security Status in the web interface:

1. Click Security, Port Security and status.
2. Checked “Auto-refresh”.

3. Click “Refresh” to refresh the port detailed statistics.
4. Click the port number to see the status for this particular port.

■ **Parameter description:**

Port:

The port number for which the status applies. Click the port number to see the status for this particular port.

Violation Mode

Shows the configured Violation Mode of the port. It can take one of four values:

Disabled: Port Security is not administratively enabled on this port.

Protect: Port Security is administratively enabled in Protect mode.

Restrict: Port Security is administratively enabled in Restrict mode.

Shutdown: Port Security is administratively enabled in Shutdown mode.

State:

Shows the current state of the port. It can take one of four values:

Disabled: No user modules are currently using the Port Security service.

Ready: The Port Security service is in use by at least one user module, and is awaiting frames from unknown MAC addresses to arrive.

Limit Reached: The Port Security service is enabled by at least the Limit Control user module, and that module has indicated that the limit is reached and no more MAC addresses should be taken in.

Shutdown: The Port Security service is enabled by at least the Limit Control user module, and that module has indicated that the limit is exceeded. No MAC addresses can be learned on the port until it is administratively re-opened on the Limit Control configuration Web-page.

MAC Count (Current, Violating, Limit)

The three columns indicate the number of currently learned MAC addresses (forwarding as well as blocked), the number of violating MAC address (only counting in Restrict mode) and the maximum number of MAC addresses that can be learned on the port, respectively.

If no user modules are enabled on the port, the Current column will show a dash (-).

If Port Security is not administratively enabled on the port, the Violating and Limit columns will show a dash (-).

■ Buttons

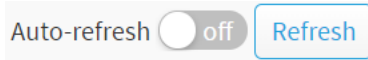

Auto-refresh:

Check this box to refresh the page automatically. Automatic refresh occurs every 3 seconds.

Refresh:

Click to refresh the page immediately.

Port 1-52 Status:

Click the port number to view the port status individually.



■ Parameter description:

MAC Address & VLAN ID:

The MAC address and VLAN ID that is seen on this port. If no MAC addresses are learned, a single row stating “No MAC addresses attached” is displayed.

State:

Indicates whether the corresponding MAC address is blocked or forwarding. In the blocked state, it will not be allowed to transmit or receive traffic.

Time of Addition:

Shows the date and time when this MAC address was first seen on the port.

Age/Hold:

If at least one user module has decided to block this MAC address, it will stay in the blocked state until the hold time (measured in seconds) expires. If all user modules have decided to allow this MAC address to forward, and aging is enabled, the Port Security module will periodically check that this MAC address still forwards traffic. If the age period (measured in seconds) expires and no frames have been seen, the MAC address will be removed from the MAC table. Otherwise a new age period will begin.

If aging is disabled or a user module has decided to hold the MAC address indefinitely, a dash (-) will be shown.

■ Buttons



Auto-refresh:

Check this box to refresh the page automatically. Automatic refresh occurs every 3 seconds.

Refresh:

Click to refresh the page immediately.

Clear:

Click to remove this particular MAC addresses from MAC table.

Port 1:

Select port that you want to display the Port Security Status.

Back:

Click to go back Port Security Status.

RADIUS

Configuration

RADIUS Server Configuration

Global Configuration

Timeout: 5 seconds

Retransmit: 3 times

Deadtime: 0 minutes

Key:

NAS-IP-Address:

NAS-IPv6-Address:

NAS-Identifier:

Server Configuration

Delete	Hostname	Auth Port	Acct Port	Timeout	Retransmit	Key
Add New Server						

[Reset](#) [Apply](#)

Web Interface

To configure a RADIUS in the web interface:

1. Click Security, RADIUS and Configuration.
2. Set Timeout, Retransmit, Deadtime, Key, NAS-IP-Address, NAS IPv6-Address, NAS-Identifier.
3. Click “Add New Entry”.

Global Configuration

Timeout: 5 seconds

Retransmit: 3 times

Deadtime: 0 minutes

Key:

NAS-IP-Address:

NAS-IPv6-Address:

NAS-Identifier:

Server Configuration

Delete	Hostname	Auth Port	Acct Port	Timeout	Retransmit	Key
Delete	<input type="text"/>	1812	1813	<input type="text"/>	<input type="text"/>	<input type="text"/>

[Add New Server](#)

[Reset](#) [Apply](#)

4. Set Hostname, Auth Port, Acct Port, Timeout, Retransmit, Key.
5. Click the Apply to save the setting.

6. If you want to cancel the setting then you need to click the Reset button. It will revert to previously saved values.

■ **Parameter description:**

Global Configuration

These settings are common for all of the RADIUS servers.

Timeout:

Timeout is the number of seconds, in the range 1 to 1000, to wait for a reply from a RADIUS server before retransmitting the request.

Retransmit:

Retransmit is the number of times, in the range 1 to 1000, a RADIUS request is retransmitted to a server that is not responding. If the server has not responded after the last retransmit it is considered to be dead.

Deadtime:

Deadtime, which can be set to a number between 0 to 1440 minutes, is the period during which the switch will not send new requests to a server that has failed to respond to a previous request. This will stop the switch from continually trying to contact a server that it has already determined as dead. Setting the Deadtime to a value greater than 0 (zero) will enable this feature, but only if more than one server has been configured.

Key:

The secret key - up to 63 characters long - shared between the RADIUS server and the switch.

NAS-IP-Address:

The IPv4 address to be used as attribute 4 in RADIUS Access-Request packets. If this field is left blank, the IP address of the outgoing interface is used.

NAS-IPv6-Address:

The IPv6 address to be used as attribute 95 in RADIUS Access-Request packets. If this field is left blank, the IP address of the outgoing interface is used.

NAS-Identifier:

The identifier - up to 255 characters long - to be used as attribute 32 in RADIUS Access-Request packets. If this field is left blank, the NAS-Identifier is not included in the packet.

Server Configuration

The table has one row for each RADIUS server and a number of columns, which are:

Hostname:

The IP address or hostname of the RADIUS server.

Auth Port:

The UDP port to use on the RADIUS server for authentication.

Acct Port:

The UDP port to use on the RADIUS server for accounting.

Timeout:

This optional setting overrides the global timeout value. Leaving it blank will use the global timeout value.

Retransmit:

This optional setting overrides the global retransmit value. Leaving it blank will use the global retransmit value.

Key:

This optional setting overrides the global key. Leaving it blank will use the global key.

■ Buttons

Delete:

To delete a RADIUS server entry, check this box. The entry will be deleted during the next Save.

Add New Entry:

Click to add a new RADIUS server. An empty row is added to the table, and the RADIUS server can be configured as needed. Up to 5 servers are supported. The button can be used to undo the addition of the new server.

Apply:

Click to save changes.

Reset:

Click to undo any changes made locally and revert to previously saved values.

Status

This section shows you an overview/detail of the RADIUS Authentication and Accounting servers' status to ensure the function is workable.

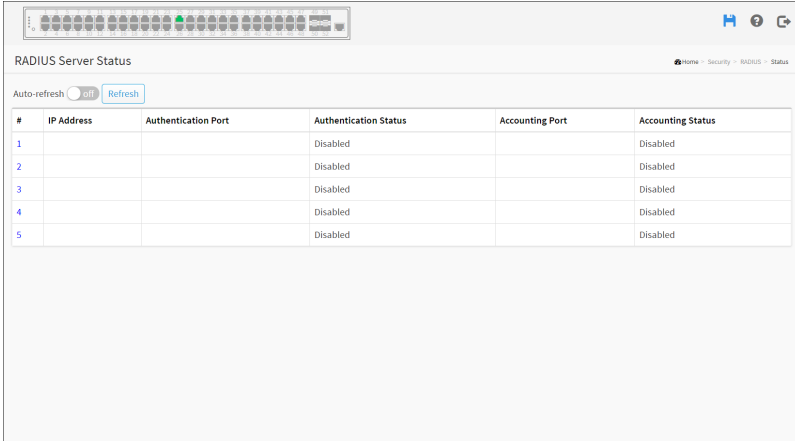

RADIUS Server Status

Auto-refresh Refresh

#	IP Address	Authentication Port	Authentication Status	Accounting Port	Accounting Status
1			Disabled		Disabled
2			Disabled		Disabled
3			Disabled		Disabled
4			Disabled		Disabled
5			Disabled		Disabled

Web Interface

To display a RADIUS Status in the web interface:

1. Click Security, RADIUS and Status.
2. Select server to display the detail statistics for a particular RADIUS.

■ Parameter description:

#:

The RADIUS server number. Click to navigate to detailed statistics for this server.

IP Address:

The IP address and UDP port number (in <IP Address>:<UDP Port> notation) of this server.

Authentication Port:

UDP port number for authentication.

Authentication Status:

The current status of the server. This field takes one of the following values:

Disabled: The server is disabled.

Not Ready: The server is enabled, but IP communication is not yet up and

running.

Ready: The server is enabled, IP communication is up and running, and the RADIUS module is ready to accept access attempts.

Dead (X seconds left): Access attempts were made to this server, but it did not reply within the configured timeout. The server has temporarily been disabled, but will get re-enabled when the dead-time expires. The number of seconds left before this occurs is displayed in parentheses. This state is only reachable when more than one server is enabled.

Accounting Port:

UDP port number for accounting.

Accounting Status:

The current status of the server. This field takes one of the following values:

Disabled: The server is disabled.

Not Ready: The server is enabled, but IP communication is not yet up and running.

Ready: The server is enabled, IP communication is up and running, and the RADIUS module is ready to accept access attempts.

Dead (X seconds left): Access attempts were made to this server, but it did not reply within the configured timeout. The server has temporarily been disabled, but will get re-enabled when the dead-time expires. The number of seconds left before this occurs is displayed in parentheses. This state is only reachable when more than one server is enabled.

Buttons

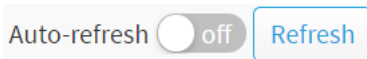

Auto-refresh:

Check this box to refresh the page automatically. Automatic refresh occurs every 3 seconds.

Refresh:

Click to refresh the page immediately.

Port 1-52 Status

Click the port number to view the port individually.

RADIUS Authentication Statistics		Transmit Packets	
Access Accepts	0	Access Requests	0
Access Rejects	0	Access Retransmissions	0
Access Challenges	0	Pending Requests	0
Malformed Access Responses	0	Timeouts	0
Bad Authenticators	0		
Unknown Types	0		
Packets Dropped	0		
Other Info			
IP Address			
State	Disabled		
Round-Trip Time	0 ms		

RADIUS Accounting Statistics for Server #1		Transmit Packets	
Responses	0	Requests	0
Malformed Responses	0	Retransmissions	0
Bad Authenticators	0	Pending Requests	0
Unknown Types	0	Timeouts	0
Packets Dropped	0		
Other Info			
IP Address			
State	Disabled		
Round-Trip Time	0 ms		

■ Parameter description:

server:

You can select which server that you want to display RADIUS.

RADIUS Authentication Statistics for Server #1

The statistics map closely to those specified in RFC4668 - RADIUS Authentication Client MIB.

Use the server select box to switch between the backend servers to show details for.

Access Accepts:

The number of RADIUS Access-Accept packets (valid or invalid) received from the server.

Access Rejects:

The number of RADIUS Access-Reject packets (valid or invalid) received from the server.

Access Challenges:

The number of RADIUS Access-Challenge packets (valid or invalid) received from the server.

Malformed Access Responses:

The number of malformed RADIUS Access-Response packets received from the server. Malformed packets include packets with an invalid length. Bad authenticators or Message Authenticator attributes or unknown types are not included as malformed access responses.

Bad Authenticators:

The number of RADIUS Access-Response packets containing invalid authenticators or Message Authenticator attributes received from the server.

Unknown Types:

The number of RADIUS packets that were received with unknown types from the server on the authentication port and dropped.

Packets Dropped:

The number of RADIUS packets that were received from the server on the authentication port and dropped for some other reason.

Access Requests:

The number of RADIUS Access-Request packets sent to the server. This does not include retransmissions.

Access Retransmissions:

The number of RADIUS Access-Request packets retransmitted to the RADIUS authentication server.

Pending Requests:

The number of RADIUS Access-Request packets destined for the server that have not yet timed out or received a response. This variable is incremented when an Access-Request is sent and decremented due to receipt of an Access-Accept, Access-Reject, Access-Challenge, timeout, or retransmission.

Timeouts:

The number of authentication timeouts to the server. After a timeout, the client may retry to the same server, send to a different server, or give up. A retry to the same server is counted as a retransmit as well as a timeout. A send to a different server is counted as a Request as well as a timeout.

IP Address:

IP address and UDP port for the authentication server in question.

State:

Shows the state of the server. It takes one of the following values:

- ◆ Disabled:
The selected server is disabled.
- ◆ Not Ready:
The server is enabled, but IP communication is not yet up and running.
- ◆ Ready:
The server is enabled, IP communication is up and running, and the RADIUS module is ready to accept access attempts.
- ◆ Dead (X seconds left):
Access attempts were made to this server, but it did not reply within the configured timeout. The server has temporarily been disabled, but will get re-enabled when the dead-time expires. The number of seconds left before this occurs is displayed in parentheses. This state is only reachable when more than one server is enabled.

Round-Trip Time:

The time interval (measured in milliseconds) between the most recent Access-Reply/Access-Challenge and the Access-Request that matched it from the RADIUS authentication server. The granularity of this measurement is 100 ms. A value of 0 ms indicates that there hasn't been round-trip communication with the server yet.

RADIUS Accounting Statistics for Server #1

The statistics map closely to those specified in RFC4670 - RADIUS Accounting Client MIB.

Use the server select box to switch between the backend servers to show details for.

Responses:

The number of RADIUS packets (valid or invalid) received from the server.

Malformed Responses:

The number of malformed RADIUS packets received from the server. Malformed packets include packets with an invalid length. Bad authenticators or unknown types are not included as malformed access responses.

Bad Authenticators:

The number of RADIUS packets containing invalid authenticators received from the server.

Unknown Types:

The number of RADIUS packets of unknown types that were received from the server on the accounting port.

Packets Dropped:

The number of RADIUS packets that were received from the server on the accounting port and dropped for some other reason.

Requests:

The number of RADIUS packets sent to the server. This does not include retransmissions

Retransmissions:

The number of RADIUS packets retransmitted to the RADIUS accounting server.

Pending Requests:

The number of RADIUS packets destined for the server that have not yet timed out or received a response. This variable is incremented when a Request is sent and decremented due to receipt of a Response, timeout, or retransmission.

Timeouts:

The number of accounting timeouts to the server. After a timeout, the client may retry to the same server, send to a different server, or give up. A retry to

the same server is counted as a retransmit as well as a timeout. A send to a different server is counted as a Request as well as a timeout.

IP Address:

IP address and UDP port for the accounting server in question.

State:

Shows the state of the server. It takes one of the following values:

- ◆ Disabled:
The selected server is disabled.
- ◆ Not Ready:
The server is enabled, but IP communication is not yet up and running.
- ◆ Ready:
The server is enabled, IP communication is up and running, and the RADIUS module is ready to accept accounting attempts.
- ◆ Dead (X seconds left):
Accounting attempts were made to this server, but it did not reply within the configured timeout. The server has temporarily been disabled, but will get re-enabled when the dead-time expires. The number of seconds left before this occurs is displayed in parentheses. This state is only reachable when more than one server is enabled.

Round-Trip Time:

The time interval (measured in milliseconds) between the most recent Response and the Request that matched it from the RADIUS accounting server. The granularity of this measurement is 100 ms. A value of 0 ms indicates that there hasn't been round-trip communication with the server yet.

Buttons



Auto-refresh:

Check this box to refresh the page automatically. Automatic refresh occurs every 3 seconds.

Refresh:

Click to refresh the page immediately.

Clear:

Clears the counters for the selected server. The “Pending Requests” counter will not be cleared by this operation.

TACACS+

This page allows you to configure up to 5 TACACS+ servers.

TACACS+ Server Configuration

Global Configuration

Timeout: 5 seconds

Deadtime: 0 minutes

Key:

Server Configuration

Delete	Hostname	Port	Timeout	Key
<input type="button" value="Add New Server"/>	<input type="text"/>	<input type="text"/>	<input type="text"/>	<input type="text"/>

Reset Apply

Web Interface

To configure the TACACS+ servers in the web interface:

1. Click Security and TACACS+.
2. Click “Add New Entry”.

Server Configuration

Delete	Hostname	Port	Timeout	Key
<input type="button" value="Remove"/>	<input type="text"/>	49	<input type="text"/>	<input type="text"/>

Reset Apply

3. Specify the Timeout, Deadtime, Key.
4. Specify the Hostname, Port, Timeout and Key in the server.
5. Click Apply.

■ Parameter description:

Global Configuration

These setting are common for all of the TACACS+ servers.

Timeout:

Timeout is the number of seconds, in the range 1 to 1000, to wait for a reply from a TACACS+ server before it is considered to be dead.

Deadtime:

Deadtime, which can be set to a number between 0 to 1440 minutes, is the period during which the switch will not send new requests to a server that has failed to respond to a previous request. This will stop the switch from continually trying to contact a server that it has already determined as dead. Setting the Deadtime to a value greater than 0 (zero) will enable this feature, but only if more than one server has been configured.

Key:

The secret key - up to 63 characters long - shared between the TACACS+ server and the switch.

Server Configuration

The table has one row for each TACACS+ server and a number of columns, which are:

Delete:

To delete a TACACS+ server entry, check this box. The entry will be deleted during the next Save.

Hostname:

The IP address or hostname of the TACACS+ server.

Port:

The TCP port to use on the TACACS+ server for authentication.

Timeout:

This optional setting overrides the global timeout value. Leaving it blank will use the global timeout value.

Key:

This optional setting overrides the global key. Leaving it blank will use the global key.

■ Buttons

Delete:

This button can be used to undo the addition of the new server.

Add New Server:

Click to add a new TACACS+ server. An empty row is added to the table, and the TACACS+ server can be configured as needed. Up to 5 servers are supported.

Apply:

Click to save changes.

Reset:

Click to undo any changes made locally and revert to previously saved values.

This Page Intentionally Left Blank

Chapter 13

Access Control

Overview

The menu is shown below:

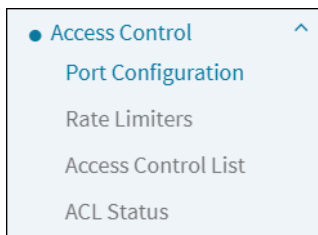

Port Configuration

Configure the ACL parameters (ACE) of each switch port. These parameters will affect frames received on a port unless the frame matches a specific ACE.

Port	Policy ID	Action	Rate Limiter ID	Port Redirect	Mirror	Logging	Shutdown	State	Counter
*	0	-->	-->	Disabled Port 1 Port 2	-->	-->	-->	-->	*
1	0	Permit	Disabled	Disabled Port 1 Port 2	Disabled	Disabled	Disabled	Enabled	0
2	0	Permit	Disabled	Disabled Port 1 Port 2	Disabled	Disabled	Disabled	Enabled	0
3	0	Permit	Disabled	Disabled Port 1 Port 2	Disabled	Disabled	Disabled	Enabled	0
4	0	Permit	Disabled	Disabled Port 1 Port 2	Disabled	Disabled	Disabled	Enabled	0
5	0	Permit	Disabled	Disabled Port 1	Disabled	Disabled	Disabled	Enabled	0

Web Interface

To configure User in the web interface:

1. Click Access Control and Port Configuration.
2. To scroll the specific parameter value to select the correct value for port ACL setting.
3. Click the apply to save the setting.
4. If you want to cancel the setting then you need to click the reset button. It will revert to previously saved values.
5. After you configure complete then you could see the Counter of the port. Then you could click refresh to update the counter or Clear the information.

■ Parameter description:

Port:

The logical port for the settings contained in the same row.

Policy ID:

Select the policy to apply to this port. The allowed values are 1 through 8. The default value is 1.

Action:

Select whether forwarding is permitted (“Permit”) or denied (“Deny”). The default value is “Permit”.

Rate Limiter ID:

Select which rate limiter to apply on this port. The allowed values are Disabled or the values 1 through 16. The default value is "Disabled".

Port Redirect:

Select which port frames are redirected on. The allowed values are Disabled or a specific port number and it can't be set when action is permitted. The default value is “Disabled”.

Mirror

Specify the mirror operation of this port. The allowed values are:

Enabled: Frames received on the port are mirrored.

Disabled: Frames received on the port are not mirrored.

The default value is “Disabled”.

Logging:

Specify the logging operation of this port. The allowed values are:

Enabled: Frames received on the port are stored in the System Log.

Disabled: Frames received on the port are not logged.

The default value is “Disabled”. Please note that the System Log memory size and logging rate is limited.

Shutdown:

Specify the port shut down operation of this port. The allowed values are:

Enabled: If a frame is received on the port, the port will be disabled.

Disabled: Port shut down is disabled.

The default value is “Disabled”.

State:

Specify the port state of this port. The allowed values are:

Enabled: To reopen ports by changing the volatile port configuration of the ACL user module.

Disabled: To close ports by changing the volatile port configuration of the ACL user module.

The default value is “Enabled”

Counter:

Counts the number of frames that match this ACE.

■ **Buttons**

Refresh, clear:

You can click them for refresh the ACL Port Configuration or clear them by manual.

Apply:

Click to save changes.

Reset:

Click to undo any changes made locally and revert to previously saved values.

Rate Limiters

The section describes how to configure the switch's ACL Rate Limiter parameters. The Rate Limiter Level from 1 to 16 that allow user to set rate limiter value and units with pps.

Rate Limiter ID	Rate	Unit
*	1	<- ▾
1	1	10pps ▾
2	1	10pps ▾
3	1	10pps ▾
4	1	10pps ▾
5	1	10pps ▾
6	1	10pps ▾
7	1	10pps ▾
8	1	10pps ▾
9	1	10pps ▾
10	1	10pps ▾

Reset Apply

Web Interface

To configure ACL Rate Limiter in the web interface:

1. Click Access Control and Rate Limiters.
2. To specific the Rate field, Unit.
3. Click the Apply to save the setting.
4. If you want to cancel the setting then you need to click the reset button. It will revert to previously saved values.

■ Parameter description:

Rate Limiter ID:

The rate limiter ID for the settings contained in the same row and its range is 1 to 16.

Rate:

The valid rate is 0, 10, 20, 30, ..., 5000000 in pps

or 0, 25, 50, 75, ..., 10000000 in kbps.

Unit

Specify the rate unit. The allowed values are:

10pps: packets per second.

25kbps: Kbits per second.

■ **Buttons**

Apply:

Click to save changes.

Reset:

Click to undo any changes made locally and revert to previously saved values.

Access Control List

This page shows the Access Control List (ACL), which is made up of the ACEs defined on this switch. Each row describes the ACE that is defined. The maximum number of ACEs is 512 on each switch.

Click on the lowest plus sign to add a new ACE to the list. The reserved ACEs used for internal protocol, cannot be edited or deleted, the order sequence cannot be changed and the priority is highest.

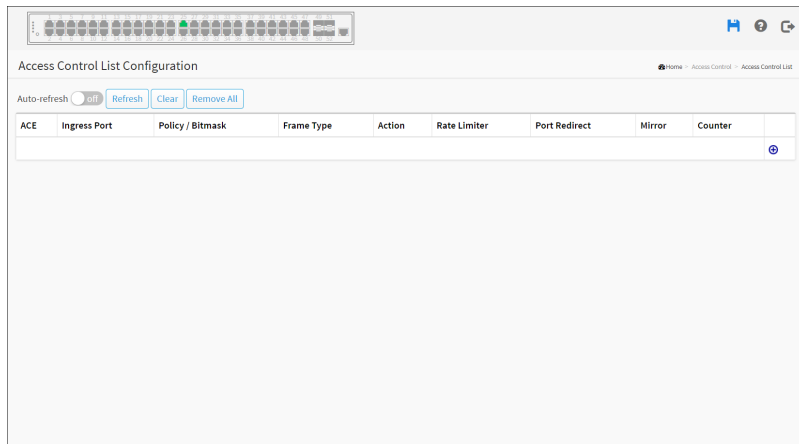

Web Interface

To configure Access Control List in the web interface:

1. Click Access Control and Access Control List.
2. Click the  button to add a new ACL, or use the other ACL modification buttons to specify the editing action (i.e., edit, delete, or moving the relative position of entry in the list).

3. Specify the parameter of the ACE.
4. Click save to save the setting.
5. If you want to cancel the setting then you need to click the reset button. It will revert to previously saved values.
6. When editing an entry on the ACE Configuration page, note that the Items displayed depend on various selections, such as Frame Type and IP Protocol Type. Specify the relevant criteria to be matched for this rule, and set the actions to take when a rule is matched (such as Rate Limiter, Port Copy, Logging, and Shutdown).

■ Parameter description:

ACE:

Indicates the ACE ID.

Ingress Port:

Indicates the ingress port of the ACE. Possible values are:

Any: The ACE will match any ingress port.

Policy: The ACE will match ingress ports with a specific policy.

Port: The ACE will match a specific ingress port.

Policy / Bitmask:

Indicates the policy number and bitmask of the ACE.

Frame Type:

Indicates the frame type of the ACE. Possible values are:

Any: The ACE will match any frame type.

EType: The ACE will match Ethernet Type frames. Note that an Ethernet Type based ACE will not get matched by IP and ARP frames.

ARP: The ACE will match ARP/RARP frames.

IPv4: The ACE will match all IPv4 frames.

IPv4/ICMP: The ACE will match IPv4 frames with ICMP protocol.

IPv4/UDP: The ACE will match IPv4 frames with UDP protocol.

IPv4/TCP: The ACE will match IPv4 frames with TCP protocol.

IPv4/Other: The ACE will match IPv4 frames, which are not ICMP/UDP/TCP.

IPv6: The ACE will match all IPv6 standard frames.

Action:

Indicates the forwarding action of the ACE.

Permit: Frames matching the ACE may be forwarded and learned.

Deny: Frames matching the ACE are dropped.

Filter: Frames matching the ACE are filtered.

Rate Limiter:

Indicates the rate limiter number of the ACE. The allowed range is 1 to 16. When Disabled is displayed, the rate limiter operation is disabled.

Port Redirect:

Indicates the port redirect operation of the ACE. Frames matching the ACE are redirected to the port number. The allowed values are Disabled or a specific port number. When Disabled is displayed, the port redirect operation is disabled.

Mirror:

Specify the mirror operation of this port. Frames matching the ACE are mirrored to the destination mirror port. The allowed values are:

Enabled: Frames received on the port are mirrored.

Disabled: Frames received on the port are not mirrored.







The default value is “Disabled”.

Counter:

The counter indicates the number of times the ACE was hit by a frame.

Modification Buttons:

You can modify each ACE (Access Control Entry) in the table using the following buttons:

- : Inserts a new ACE before the current row.
- : Edits the ACE row.
- : Moves the ACE up the list.
- : Moves the ACE down the list.
- : Deletes the ACE.
- : The lowest plus sign adds a new entry at the bottom of the ACE listings.

ACE Configuration

An ACE consists of several parameters. These parameters vary according to the frame type that you select. First select the ingress port for the ACE, and then select the frame type. Different parameter options are displayed depending on the frame type selected.

A frame that hits this ACE matches the configuration that is defined here.

Ingress Port:

Select the ingress port for which this ACE applies.

All: The ACE applies to all port.

Port n: The ACE applies to this port number, where n is the number of the switch port.

Policy Filter:

Specify the policy number filter for this ACE.

Any: No policy filter is specified. (policy filter status is “don't-care”.)

Specific: If you want to filter a specific policy with this ACE, choose this value. Two field for entering an policy value and bitmask appears.

Policy Value:

When “Specific” is selected for the policy filter, you can enter a specific policy value. The allowed range is 0 to 255.

Policy Bitmask:

When “Specific” is selected for the policy filter, you can enter a specific policy bitmask. The allowed range is 0x0 to 0xff. Notice the usage of bitmask, if the binary bit value is “0”, it means this bit is “don't-care”. The real matched pattern is [policy_value & policy_bitmask]. For example, if the policy value is 3 and the policy bitmask is 0x10(bit 0 is “don't-care” bit), then policy 2 and 3 are applied to this rule.

Frame Type:

Select the frame type for this ACE. These frame types are mutually exclusive.

Any: Any frame can match this ACE.

Ethernet Type: Only Ethernet Type frames can match this ACE. The IEEE 802.3 describes the value of Length/Type Field specifications to be greater than or equal to 1536 decimal (equal to 0600 hexadecimal).

ARP: Only ARP frames can match this ACE. Notice the ARP frames won't match the ACE with ethernet type.

IPv4: Only IPv4 frames can match this ACE. Notice the IPv4 frames won't match the ACE with ethernet type.

IPv6: Only IPv6 frames can match this ACE. Notice the IPv6 frames won't match the ACE with Ethernet type.

Action:

Specify the action to take with a frame that hits this ACE.

Permit: The frame that hits this ACE is granted permission for the ACE operation.

Deny: The frame that hits this ACE is dropped.

Filter: Frames matching the ACE are filtered.

Rate Limiter:

Specify the rate limiter in number of base units. The allowed range is 1 to 16. Disabled indicates that the rate limiter operation is disabled.

Port Redirect:

Frames that hit the ACE are redirected to the port number specified here. The rate limiter will affect these ports. The allowed range is the same as the switch port number range. Disabled indicates that the port redirect operation is disabled and the specific port number of 'Port Redirect' can't be set when action is permitted.

Mirror:

Specify the mirror operation of this port. Frames matching the ACE are mirrored to the destination mirror port. The rate limiter will not affect frames on the mirror port. The allowed values are:

Enabled: Frames received on the port are mirrored.

Disabled: Frames received on the port are not mirrored.

The default value is "Disabled".

Logging:

Specify the logging operation of the ACE. Notice that the logging message doesn't include the 4 bytes CRC information. The allowed values are:

Enabled: Frames matching the ACE are stored in the System Log.

Disabled: Frames matching the ACE are not logged.

Note: The logging feature only works when the packet length is less than 1518(without VLAN tags) and the System Log memory size and logging rate is limited.

Shutdown:

Specify the port shut down operation of the ACE. The allowed values are:

Enabled: If a frame matches the ACE, the ingress port will be disabled.

Disabled: Port shut down is disabled for the ACE.

Note: The shutdown feature only works when the packet length is less than 1518(without VLAN tags).

Counter:

The counter indicates the number of times the ACE was hit by a frame.

MAC Parameter**SMAC Filter:**

(Only displayed when the frame type is Ethernet Type or ARP.)

Specify the source MAC filter for this ACE.

Any: No SMAC filter is specified. (SMAC filter status is "don't-care".)

Specific: If you want to filter a specific source MAC address with this ACE, choose this value. A field for entering an SMAC value appears.

SMAC Value:

When "Specific" is selected for the SMAC filter, you can enter a specific source MAC address. The legal format is "xx-xx-xx-xx-xx-xx" or "xx.xx.xx.xx.xx.xx" or "xxxxxxxxxxxx" (x is a hexadecimal digit). A frame that hits this ACE matches this SMAC value.

DMAC Filter:

Specify the destination MAC filter for this ACE.

Any: No DMAC filter is specified. (DMAC filter status is "don't-care".)

MC: Frame must be multicast.

BC: Frame must be broadcast.

UC: Frame must be unicast.

Specific: If you want to filter a specific destination MAC address with this ACE, choose this value. A field for entering a DMAC value appears.

DMAC Value:

When “Specific” is selected for the DMAC filter, you can enter a specific destination MAC address. The legal format is “xx-xx-xx-xx-xx-xx” or “xx.xx.xx.xx.xx.xx” or “xxxxxxxxxxxx” (x is a hexadecimal digit). A frame that hits this ACE matches this DMAC value.

VLAN Parameters

802.1Q Tagged:

Specify whether frames can hit the action according to the 802.1Q tagged. The allowed values are:

Any: Any value is allowed (“don't-care”).

Enabled: Tagged frame only.

Disabled: Untagged frame only.

The default value is “Any”.

VLAN ID Filter:

Specify the VLAN ID filter for this ACE.

Any: No VLAN ID filter is specified. (VLAN ID filter status is “don't-care”).

Specific: If you want to filter a specific VLAN ID with this ACE, choose this value. A field for entering a VLAN ID number appears.

VLAN ID:

When “Specific” is selected for the VLAN ID filter, you can enter a specific VLAN ID number. The allowed range is 1 to 4095. A frame that hits this ACE matches this VLAN ID value.

Tag Priority:

Specify the tag priority for this ACE. A frame that hits this ACE matches this tag priority. The allowed number range is 0 to 7 or range 0-1, 2-3, 4-5, 6-7, 0-3 and 4-7. The value Any means that no tag priority is specified (tag priority is “don't-care”).

ARP Parameters

The ARP parameters can be configured when Frame Type “ARP” is selected.

ARP/RARP:

Specify the available ARP/RARP opcode (OP) flag for this ACE.

Any: No ARP/RARP OP flag is specified. (OP is “don't-care”.)

ARP: Frame must have ARP opcode set to ARP.

RARP: Frame must have RARP opcode set to RARP.

Other: Frame has unknown ARP/RARP Opcode flag.

Request/Reply:

Specify the available Request/Reply opcode (OP) flag for this ACE.

Any: No Request/Reply OP flag is specified. (OP is “don't-care”.)

Request: Frame must have ARP Request or RARP Request OP flag set.

Reply: Frame must have ARP Reply or RARP Reply OP flag.

Sender IP Filter:

Specify the sender IP filter for this ACE.

Any: No sender IP filter is specified. (Sender IP filter is “don't-care”.)

Host: Sender IP filter is set to Host. Specify the sender IP address in the SIP Address field that appears.

Network: Sender IP filter is set to Network. Specify the sender IP address and sender IP mask in the SIP Address and SIP Mask fields that appear.

Sender IP Address:

When “Host” or “Network” is selected for the sender IP filter, you can enter a specific sender IP address in dotted decimal notation.

Sender IP Mask:

When “Network” is selected for the sender IP filter, you can enter a specific sender IP mask in dotted decimal notation.

Target IP Filter:

Specify the target IP filter for this specific ACE.

Any: No target IP filter is specified. (Target IP filter is “don't-care”.)

Host: Target IP filter is set to Host. Specify the target IP address in the Target IP Address field that appears. Network: Target IP filter is set to Network. Specify the target IP address and target IP mask in the Target IP Address and Target IP Mask fields that appear.

Target IP Address:

When “Host” or “Network” is selected for the target IP filter, you can enter a specific target IP address in dotted decimal notation.

Target IP Mask:

When “Network” is selected for the target IP filter, you can enter a specific target IP mask in dotted decimal notation.

ARP Sender MAC Match:

Specify whether frames can hit the action according to their sender hardware address field (SHA) settings.

0: ARP frames where SHA is not equal to the SMAC address.

1: ARP frames where SHA is equal to the SMAC address.

Any: Any value is allowed (“don't-care”).

RARP Target MAC Match:

Specify whether frames can hit the action according to their target hardware address field (THA) settings.

0: RARP frames where THA is not equal to the target MAC address.

1: RARP frames where THA is equal to the target MAC address.

Any: Any value is allowed (“don't-care”).

IP/Ethernet Length:

Specify whether frames can hit the action according to their ARP/RARP hardware address length (HLN) and protocol address length (PLN) settings.

0: ARP/RARP frames where the HLN is not equal to Ethernet (0x06) or the (PLN) is not equal to IPv4 (0x04).

1: ARP/RARP frames where the HLN is equal to Ethernet (0x06) and the (PLN) is equal to IPv4 (0x04).

Any: Any value is allowed (“don't-care”).

Ethernet:

Specify whether frames can hit the action according to their ARP/RARP hardware address space (HRD) settings.

0: ARP/RARP frames where the HLD is not equal to Ethernet (1).

1: ARP/RARP frames where the HLD is equal to Ethernet (1).

Any: Any value is allowed (“don't-care”).

IP:

Specify whether frames can hit the action according to their ARP/RARP protocol address space (PRO) settings.

0: ARP/RARP frames where the PRO is not equal to IP (0x800).

1: ARP/RARP frames where the PRO is equal to IP (0x800).

Any: Any value is allowed (“don't-care”).

IP Parameters

The IP parameters can be configured when Frame Type “IPv4” is selected.

IP Protocol Filter:

Specify the IP protocol filter for this ACE.

Any: No IP protocol filter is specified (“don't-care”).

Specific: If you want to filter a specific IP protocol filter with this ACE, choose this value. A field for entering an IP protocol filter appears.

ICMP: Select ICMP to filter IPv4 ICMP protocol frames. Extra fields for defining ICMP parameters will appear. These fields are explained later in this help file.

UDP: Select UDP to filter IPv4 UDP protocol frames. Extra fields for defining UDP parameters will appear. These fields are explained later in this help file.

TCP: Select TCP to filter IPv4 TCP protocol frames. Extra fields for defining TCP parameters will appear. These fields are explained later in this help file.

IP Protocol Value:

When “Specific” is selected for the IP protocol value, you can enter a specific value. The allowed range is 0 to 255. A frame that hits this ACE matches this IP protocol value.

IP TTL:

Specify the Time-to-Live settings for this ACE.

zero: IPv4 frames with a Time-to-Live field greater than zero must not be able to match this entry.

non-zero: IPv4 frames with a Time-to-Live field greater than zero must be able to match this entry.

Any: Any value is allowed (“don't-care”).

IP Fragment:

Specify the fragment offset settings for this ACE. This involves the settings for the More Fragments (MF) bit and the Fragment Offset (FRAG OFFSET) field for an IPv4 frame.

No: IPv4 frames where the MF bit is set or the FRAG OFFSET field is greater than zero must not be able to match this entry.

Yes: IPv4 frames where the MF bit is set or the FRAG OFFSET field is greater than zero must be able to match this entry.

Any: Any value is allowed (“don't-care”).

IP Option:

Specify the options flag setting for this ACE.

No: IPv4 frames where the options flag is set must not be able to match this entry.

Yes: IPv4 frames where the options flag is set must be able to match this entry.

Any: Any value is allowed (“don't-care”).

SIP Filter:

Specify the source IP filter for this ACE.

Any: No source IP filter is specified. (Source IP filter is “don't-care”).

Host: Source IP filter is set to Host. Specify the source IP address in the SIP Address field that appears.

Network: Source IP filter is set to Network. Specify the source IP address and source IP mask in the SIP Address and SIP Mask fields that appear.

SIP Address:

When “Host” or “Network” is selected for the source IP filter, you can enter a specific SIP address in dotted decimal notation.

SIP Mask:

When “Network” is selected for the source IP filter, you can enter a specific SIP mask in dotted decimal notation.

DIP Filter:

Specify the destination IP filter for this ACE.

Any: No destination IP filter is specified. (Destination IP filter is “don't-care”).

Host: Destination IP filter is set to Host. Specify the destination IP address in the DIP Address field that appears.

Network: Destination IP filter is set to Network. Specify the destination IP address and destination IP mask in the DIP Address and DIP Mask fields that appear.

DIP Address:

When “Host” or “Network” is selected for the destination IP filter, you can enter a specific DIP address in dotted decimal notation.

DIP Mask:

When “Network” is selected for the destination IP filter, you can enter a specific DIP mask in dotted decimal notation.

IPv6 Parameters

The IPv6 parameters can be configured when Frame Type "IPv6" is selected.

Next Header Filter:

Specify the IPv6 next header filter for this ACE.

Any: No IPv6 next header filter is specified (“don't-care”).

Specific: If you want to filter a specific IPv6 next header filter with this ACE, choose this value. A field for entering an IPv6 next header filter appears.

ICMP: Select ICMP to filter IPv6 ICMP protocol frames. Extra fields for defining ICMP parameters will appear. These fields are explained later in this help file.

UDP: Select UDP to filter IPv6 UDP protocol frames. Extra fields for defining UDP parameters will appear. These fields are explained later in this help file.

TCP: Select TCP to filter IPv6 TCP protocol frames. Extra fields for defining TCP parameters will appear. These fields are explained later in this help file.

Next Header Value:

When “Specific” is selected for the IPv6 next header value, you can enter a specific value. The allowed range is 0 to 255. A frame that hits this ACE matches this IPv6 protocol value.

SIP Filter:

Specify the source IPv6 filter for this ACE.

Any: No source IPv6 filter is specified. (Source IPv6 filter is “don't-care”).

Specific: Source IPv6 filter is set to Network. Specify the source IPv6 address and source IPv6 mask in the SIP Address fields that appear.

SIP Address:

When “Specific” is selected for the source IPv6 filter, you can enter a specific SIPv6 address. The field only supported last 32 bits for IPv6 address.

SIP BitMask:

When “Specific” is selected for the source IPv6 filter, you can enter a specific SIPv6 mask. The field only supported last 32 bits for IPv6 address. Notice the usage of bitmask, if the binary bit value is “0”, it means this bit is “don't-care”. The real matched pattern is [sipv6_address & sipv6_bitmask] (last 32 bits). For example, if the SIPv6 address is 2001::3 and the SIPv6 bitmask is 0xFFFFFFFFE(bit 0 is “don't-care” bit), then SIPv6 address 2001::2 and 2001::3 are applied to this rule.

Hop Limit:

Specify the hop limit settings for this ACE.

zero: IPv6 frames with a hop limit field greater than zero must not be able to match this entry.

non-zero: IPv6 frames with a hop limit field greater than zero must be able to match this entry.

Any: Any value is allowed (“don't-care”).

ICMP Parameters

ICMP Type Filter:

Specify the ICMP filter for this ACE.

Any: No ICMP filter is specified (ICMP filter status is “don't-care”).

Specific: If you want to filter a specific ICMP filter with this ACE, you can enter a specific ICMP value. A field for entering an ICMP value appears.

ICMP Type Value:

When “Specific” is selected for the ICMP filter, you can enter a specific ICMP value. The allowed range is 0 to 255. A frame that hits this ACE matches this ICMP value.

ICMP Code Filter:

Specify the ICMP code filter for this ACE.

Any: No ICMP code filter is specified (ICMP code filter status is “don't-care”).

Specific: If you want to filter a specific ICMP code filter with this ACE, you can enter a specific ICMP code value. A field for entering an ICMP code value appears.

ICMP Code Value:

When “Specific” is selected for the ICMP code filter, you can enter a specific ICMP code value. The allowed range is 0 to 255. A frame that hits this ACE matches this ICMP code value.

TCP/UDP Parameters

TCP/UDP Source Filter:

Specify the TCP/UDP source filter for this ACE.

Any: No TCP/UDP source filter is specified (TCP/UDP source filter status is “don't-care”).

Specific: If you want to filter a specific TCP/UDP source filter with this ACE, you can enter a specific TCP/UDP source value. A field for entering a TCP/UDP source value appears.

Range: If you want to filter a specific TCP/UDP source range filter with this ACE, you can enter a specific TCP/UDP source range value. A field for entering a TCP/UDP source value appears.

TCP/UDP Source No.:

When “Specific” is selected for the TCP/UDP source filter, you can enter a specific TCP/UDP source value. The allowed range is 0 to 65535. A frame that hits this ACE matches this TCP/UDP source value.

TCP/UDP Source Range:

When “Range” is selected for the TCP/UDP source filter, you can enter a specific TCP/UDP source range value. The allowed range is 0 to 65535. A frame that hits this ACE matches this TCP/UDP source value.

TCP/UDP Destination Filter:

Specify the TCP/UDP destination filter for this ACE.

Any: No TCP/UDP destination filter is specified (TCP/UDP destination filter status is “don't-care”).

Specific: If you want to filter a specific TCP/UDP destination filter with this ACE, you can enter a specific TCP/UDP destination value. A field for entering a TCP/UDP destination value appears.

Range: If you want to filter a specific range TCP/UDP destination filter with this ACE, you can enter a specific TCP/UDP destination range value. A field for entering a TCP/UDP destination value appears.

TCP/UDP Destination Number:

When “Specific” is selected for the TCP/UDP destination filter, you can enter a specific TCP/UDP destination value. The allowed range is 0 to 65535. A frame that hits this ACE matches this TCP/UDP destination value.

TCP/UDP Destination Range:

When “Range” is selected for the TCP/UDP destination filter, you can enter a specific TCP/UDP destination range value. The allowed range is 0 to 65535. A frame that hits this ACE matches this TCP/UDP destination value.

TCP FIN:

Specify the TCP “No more data from sender” (FIN) value for this ACE.

0: TCP frames where the FIN field is set must not be able to match this entry.

1: TCP frames where the FIN field is set must be able to match this entry.

Any: Any value is allowed (“don't-care”).

TCP SYN:

Specify the TCP “Synchronize sequence numbers” (SYN) value for this ACE.

0: TCP frames where the SYN field is set must not be able to match this entry.

1: TCP frames where the SYN field is set must be able to match this entry.

Any: Any value is allowed (“don't-care”).

TCP RST:

Specify the TCP “Reset the connection” (RST) value for this ACE.

0: TCP frames where the RST field is set must not be able to match this entry.

1: TCP frames where the RST field is set must be able to match this entry.

Any: Any value is allowed (“don't-care”).

TCP PSH:

Specify the TCP “Push Function” (PSH) value for this ACE.

0: TCP frames where the PSH field is set must not be able to match this entry.

1: TCP frames where the PSH field is set must be able to match this entry.

Any: Any value is allowed (“don't-care”).

TCP ACK:

Specify the TCP “Acknowledgment field significant” (ACK) value for this ACE.

0: TCP frames where the ACK field is set must not be able to match this entry.

1: TCP frames where the ACK field is set must be able to match this entry.

Any: Any value is allowed (“don't-care”).

TCP URG:

Specify the TCP “Urgent Pointer field significant” (URG) value for this ACE.

0: TCP frames where the URG field is set must not be able to match this entry.

1: TCP frames where the URG field is set must be able to match this entry.

Any: Any value is allowed (“don't-care”).

Ethernet Type Parameters

The Ethernet Type parameters can be configured when Frame Type “Ethernet Type” is selected.

EtherType Filter:

Specify the Ethernet type filter for this ACE.

Any: No EtherType filter is specified (EtherType filter status is “don't-care”).

Specific: If you want to filter a specific EtherType filter with this ACE, you can enter a specific EtherType value. A field for entering a EtherType value appears.

Ethernet Type Value:

When “Specific” is selected for the EtherType filter, you can enter a specific EtherType value. The allowed range is 0x600 to 0xFFFF but excluding 0x800(IPv4), 0x806(ARP) and 0x86DD(IPv6). A frame that hits this ACE matches this EtherType value.

■ Buttons

Apply:

Click to save changes.

Reset:

Click to undo any changes made locally and revert to previously saved values.

Auto-refresh:

To evoke the auto-refresh to refresh the information automatically.

Refresh, clear, Remove All:

You can click them for refresh the ACL configuration or clear them by manual. Others remove all to clean up all ACL configurations on the table.

Cancel:

Return to the previous page.

ACL Status

The section describes how to shows the ACL status by different ACL users. Each row describes the ACE that is defined. It is a conflict if a specific ACE is not applied to the hardware due to hardware limitations. The maximum number of ACEs is 512 on each switch.

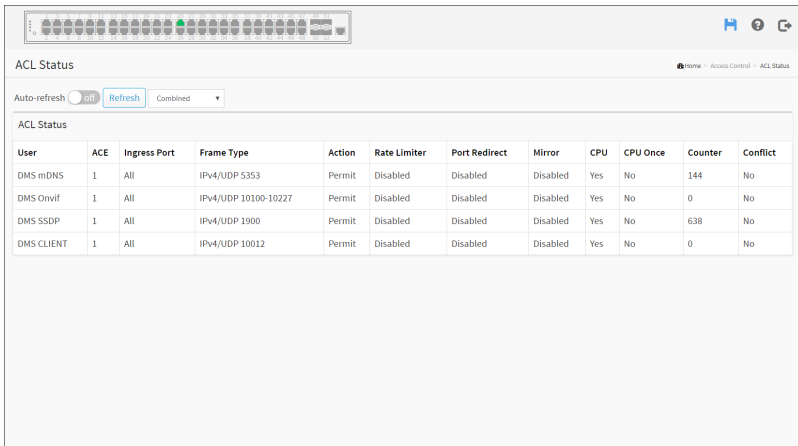

The screenshot shows the ACL Status page in a web interface. At the top, there is a navigation bar with a home icon, a help icon, and a refresh icon. Below the navigation bar, the page title is "ACL Status" and the breadcrumb is "Home > Access Control > ACL Status". There is an "Auto-refresh" toggle set to "off" and a "Refresh" button. The main content is a table with the following data:

User	ACE	Ingress Port	Frame Type	Action	Rate Limiter	Port Redirect	Mirror	CPU	CPU Once	Counter	Conflict
DMS mDNS	1	All	IPv4/UDP 5353	Permit	Disabled	Disabled	Disabled	Yes	No	144	No
DMS Onvif	1	All	IPv4/UDP 10100-10227	Permit	Disabled	Disabled	Disabled	Yes	No	0	No
DMS SSDP	1	All	IPv4/UDP 1900	Permit	Disabled	Disabled	Disabled	Yes	No	638	No
DMS CLIENT	1	All	IPv4/UDP 10012	Permit	Disabled	Disabled	Disabled	Yes	No	0	No

Web Interface

To display the ACL status in the web interface:

1. Click Access Control and ACL status.
2. If you want to auto-refresh the information then you need to evoke the “Auto-refresh”.
3. Click “Refresh“ to refresh the ACL Status.

■ Parameter description:

User:

Indicates the ACL user.

ACE:

Indicates the ACE ID on local switch.

Frame Type:

Indicates the frame type of the ACE. Possible values are:

Any: The ACE will match any frame type.

EType: The ACE will match Ethernet Type frames. Note that an Ethernet Type based ACE will not get matched by IP and ARP frames.

ARP: The ACE will match ARP/RARP frames.

IPv4: The ACE will match all IPv4 frames.

IPv4: The ACE will match all IPv4 frames.

IPv4/ICMP: The ACE will match IPv4 frames with ICMP protocol.

IPv4/UDP: The ACE will match IPv4 frames with UDP protocol.

IPv4/TCP: The ACE will match IPv4 frames with TCP protocol.

IPv4/Other: The ACE will match IPv4 frames, which are not ICMP / UDP / TCP.

IPv6: The ACE will match all IPv6 standard frames.

Action:

Indicates the forwarding action of the ACE.

Permit: Frames matching the ACE may be forwarded and learned.

Deny: Frames matching the ACE are dropped.

Filter: Frames matching the ACE are filtered.

Rate Limiter:

Indicates the rate limiter number of the ACE. The allowed range is 1 to 16. When Disabled is displayed, the rate limiter operation is disabled.

CPU:

Forward packet that matched the specific ACE to CPU.

Counter:

The counter indicates the number of times the ACE was hit by a frame.

Conflict:

Indicates the hardware status of the specific ACE. The specific ACE is not applied to the hardware due to hardware limitations.

■ Buttons

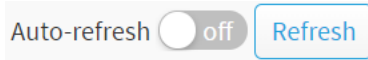

Auto-refresh:

Check this box to refresh the page automatically. Automatic refresh occurs every 3 seconds.

Refresh:

Click to refresh the page immediately.

Overview

Any Network Management System (NMS) running the Simple Network Management Protocol (SNMP) can manage the Managed devices equipped with SNMP agent, provided that the Management Information Base (MIB) is installed correctly on the managed devices. The SNMP is a protocol that is used to govern the transfer of information between SNMP manager and agent and traverses the Object Identity (OID) of the management Information Base (MIB), described in the form of SMI syntax. SNMP agent is running on the switch to response the request issued by SNMP manager.

Basically, it is passive except issuing the trap information. The switch supports a switch to turn on or off the SNMP agent. If you set the field SNMP “Enable”, SNMP agent will be started up. All supported MIB OIDs, including RMON MIB, can be accessed via SNMP manager. If the field SNMP is set “Disable”, SNMP agent will be de-activated, the related Community Name, Trap Host IP Address, Trap and all MIB counters will be ignored.

The menu is shown below:

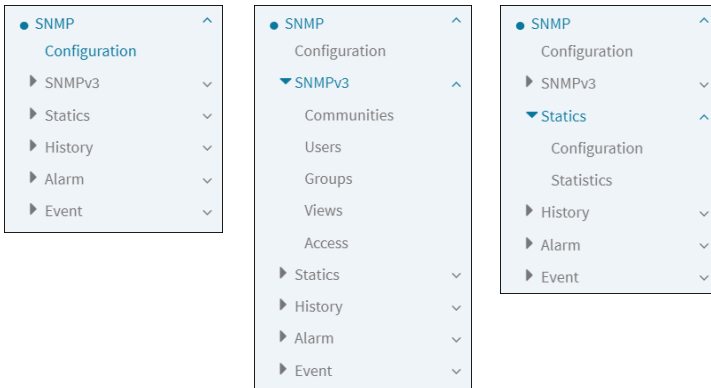

- SNMP ^
- Configuration
- ▶ SNMPv3 v
- ▶ Statics v
- ▼ History ^
- Configuration
- Status
- ▶ Alarm v
- ▶ Event v

- SNMP ^
- Configuration
- ▶ SNMPv3 v
- ▶ Statics v
- ▶ History v
- ▼ Alarm ^
- Configuration
- Status
- ▶ Event v

- SNMP ^
- Configuration
- ▶ SNMPv3 v
- ▶ Statics v
- ▶ History v
- ▶ Alarm v
- ▼ Event ^
- Configuration
- Status

Configuration

This section describes how to configure SNMP System on the switch. This function is used to configure SNMP settings, community name, trap host and public traps as well as the throttle of SNMP. A SNMP manager must pass the authentication by identifying both community names, then it can access the MIB information of the target device. So, both parties must have the same community name. Once completing the setting, click Apply for the settings to take effect.

The screenshot displays the 'SNMP Configuration' web page. At the top, there is a navigation bar with a home icon, a user icon, and a refresh icon. Below the title, there is a breadcrumb trail: 'Home > SNMP > Configuration'. The main configuration area contains a 'Mode' section with a toggle switch currently set to 'on'. Below this are two rows for community configuration: 'Read Community' with a text input field containing 'public', and 'Write Community' with a text input field containing 'private' and a dropdown menu set to 'Enabled'. At the bottom right of the configuration area, there are two buttons: 'Reset' and 'Apply'.

Web Interface

To configure User in the web interface:

1. Click SNMP and configuration.
2. Evoke SNMP State to enable or disable the SNMP function.
3. Specify the Read Community, Write Community.
4. Click Apply.

■ Parameter description:

Mode:

Indicates the SNMP mode operation. Possible modes are:

on: Enable SNMP mode operation.

off: Disable SNMP mode operation.

Read Community:

Indicates the community read access string to permit access to SNMP agent. The allowed string length is 1 to 31, and the allowed content is the ASCII characters from 33 to 126.

The field is applicable only when SNMP version is SNMPv1 or SNMPv2c. If SNMP version is SNMPv3, the community string will be associated with SNMPv3 communities table. It provides more flexibility to configure security name than a SNMPv1 or SNMPv2c community string. In addition to community string, a particular range of source addresses can be used to restrict source subnet.

Write Community:

Indicates the community write access string to permit access to SNMP agent. The allowed string length is 1 to 31, and the allowed content is the ASCII characters from 33 to 126.

The field is applicable only when SNMP version is SNMPv1 or SNMPv2c. If SNMP version is SNMPv3, the community string will be associated with SNMPv3 communities table. It provides more flexibility to configure security name than a SNMPv1 or SNMPv2c community string. In addition to community string, a particular range of source addresses can be used to restrict source subnet.

■ Buttons

Apply:

Click to save changes.

Reset:

Click to undo any changes made locally and revert to previously saved values.

SNMPv3

Communities

Configure SNMPv3 community table on this page. The entry index key is Community.

The screenshot shows the 'SNMPv3 Community Configuration' page. At the top, there is a breadcrumb trail: Home > SNMP > SNMPv3 > Communities. Below the title, there is a table with the following structure:

Delete	Community	Source IP	Source Mask
Add New Entry			

At the bottom right of the page, there are 'Reset' and 'Apply' buttons.

Web Interface

To configure the configure SNMP Communities in the web interface:

1. Click SNMP, SNMPv3 and Communities.
2. Click Add New Entry.

The screenshot shows the 'SNMPv3 Community Configuration' page after clicking 'Add New Entry'. The table now has one row with input fields:

Delete	Community	Source IP	Source Mask
Delete	<input type="text"/>	<input type="text" value="0.0.0.0"/>	<input type="text" value="0.0.0.0"/>

Below the table, there is an 'Add New Entry' button. At the bottom right of the page, there are 'Reset' and 'Apply' buttons.

3. Specify the SNMP community parameters.
4. Click Apply.

5. If you want to modify or clear the setting then click Reset.

■ **Parameter description:**

Community:

Indicates the security name to map the community to the SNMP Groups configuration. The allowed string length is 1 to 32, and the allowed content is ASCII characters from 33 to 126.

Source IP:

Indicates the SNMP access source address. A particular range of source addresses can be used to restrict source subnet when combined with source mask.

Source IP Prefix:

Indicates the SNMP access source address prefix.

■ **Buttons**

Add New Entry:

Click to add new entry. Specify the name and configure the new entry. Click “Apply”.

Delete:

Check to delete the entry. It will be deleted during the next save.

Apply:

Click to save changes.

Reset:

Click to undo any changes made locally and revert to previously saved values.

Users

The function is used to configure SNMPv3 user. The Entry index key is UserName. To create a new UserName account, please check <Add new user> button, and enter the user information then check <Apply>. Max Group Number: 6.

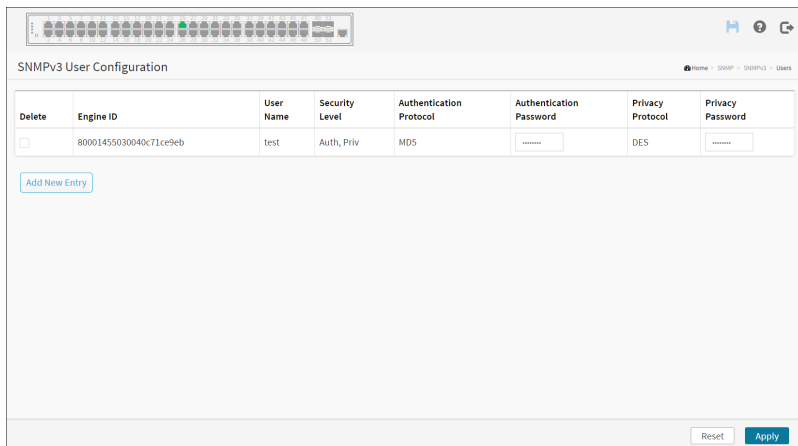

Web Interface

To configure SNMP Users in the web interface:

1. Click SNMP, SNMPv3 and Users.
2. Click Add new entry.

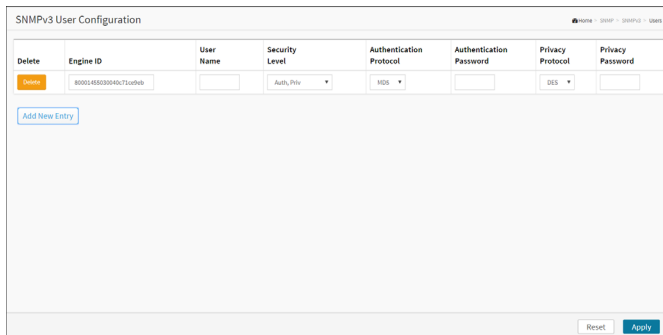

3. Specify the SNMPv3 Users parameter.
4. Click Apply.

■ Parameter description:

Engine ID:

An octet string identifying the engine ID that this entry should belong to. The string must contain an even number (in hexadecimal format) with number of digits between 10 and 64, but all-zeros and all-'F's are not allowed. The

SNMPv3 architecture uses the User-based Security Model (USM) for message security and the View-based Access Control Model (VACM) for access control. For the USM entry, the `usmUserEngineID` and `usmUserName` are the entry's keys. In a simple agent, `usmUserEngineID` is always that agent's own `snmpEngineID` value. The value can also take the value of the `snmpEngineID` of a remote SNMP engine with which this user can communicate. In other words, if user engine ID equal system engine ID then it is local user; otherwise it's remote user.

User Name:

A string identifying the user name that this entry should belong to. The allowed string length is 1 to 31, and the allowed content is ASCII characters from 33 to 126.

Security Level:

Indicates the security model that this entry should belong to. Possible security models are:

NoAuth, NoPriv: No authentication and no privacy.

Auth, NoPriv: Authentication and no privacy.

Auth, Priv: Authentication and privacy.

The value of security level cannot be modified if entry already exists. That means it must first be ensured that the value is set correctly.

Authentication Protocol:

Indicates the authentication protocol that this entry should belong to. Possible authentication protocols are:

MD5: An optional flag to indicate that this user uses MD5 authentication protocol.

SHA: An optional flag to indicate that this user uses SHA authentication protocol.

The value of security level cannot be modified if entry already exists. That means must first ensure that the value is set correctly.

Authentication Password:

A string identifying the authentication password phrase. For MD5 authentication protocol, the allowed string length is 8 to 39. For SHA authentication protocol, the allowed string length is 8 to 39. The allowed content is ASCII characters from 33 to 126.

Privacy Protocol:

Indicates the privacy protocol that this entry should belong to. Possible privacy protocols are:

DES: An optional flag to indicate that this user uses DES authentication protocol.

AES: An optional flag to indicate that this user uses AES authentication protocol.

Privacy Password:

A string identifying the privacy password phrase. The allowed string length is 8 to 31, and the allowed content is ASCII characters from 33 to 126.

■ Buttons**Add New Entry:**

Click to add new entry. Specify the name and configure the new entry. Click “Apply”.

Delete:

Check to delete the entry. It will be deleted during the next save.

Apply:

Click to save changes.

Reset:

Click to undo any changes made locally and revert to previously saved values.

Groups

The function is used to configure SNMPv3 group. The Entry index key are Security Model and Security Name. To create a new group account, please check <Add new group> button, and enter the group information then check <Apply>. Max Group Number:12.

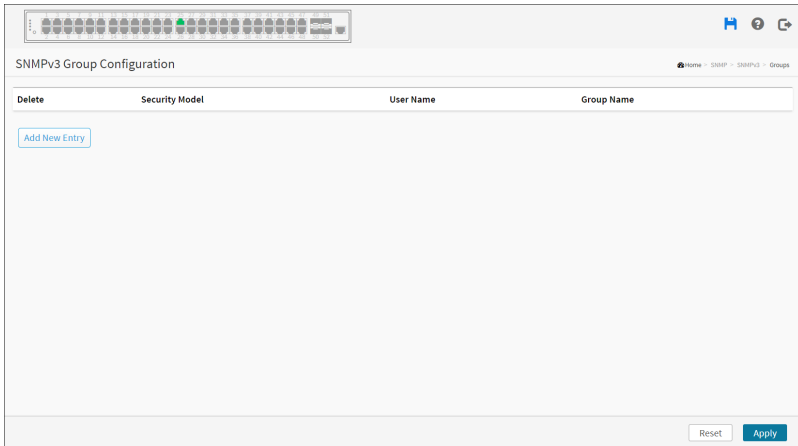

Web Interface

To configure SNMP Groups in the web interface:

1. Click SNMP, SNMPv3 and Groups.
2. Click Add new entry.

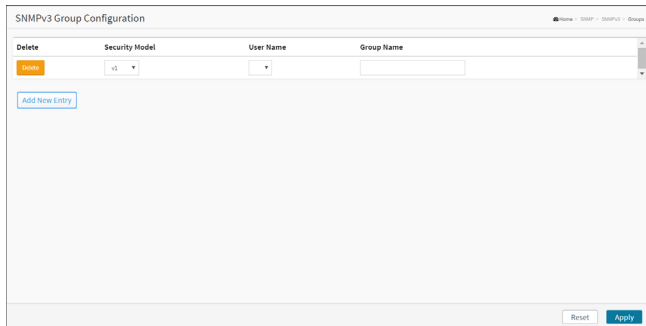

3. Specify the SNMP group parameter.
4. Click Apply.

■ Parameter description:

Security Model:

Indicates the security model that this entry should belong to. Possible security models are:

v1: Reserved for SNMPv1.

v2c: Reserved for SNMPv2c.

usm: User-based Security Model (USM).

Security Name:

A string identifying the security name that this entry should belong to. The allowed string length is 1 to 31, and the allowed content is ASCII characters from 33 to 126.

Group Name:

A string identifying the group name that this entry should belong to. The allowed string length is 1 to 32, and the allowed content is ASCII characters from 33 to 126.

■ Buttons

Add New Entry:

Click to add new entry. Specify the name and configure the new entry. Click “Apply”.

Delete:

Check to delete the entry. It will be deleted during the next save.

Apply:

Click to save changes.

Reset:

Click to undo any changes made locally and revert to previously saved values.

Views

The function is used to configure SNMPv3 view. The Entry index keys are OID Subtree and View Name. To create a new view account, please check <Add new view> button, and enter the view information then click <Apply>. Max Group Number: 12.

Configure SNMPv3 view table on this page. The entry index keys are View Name and OID Subtree.

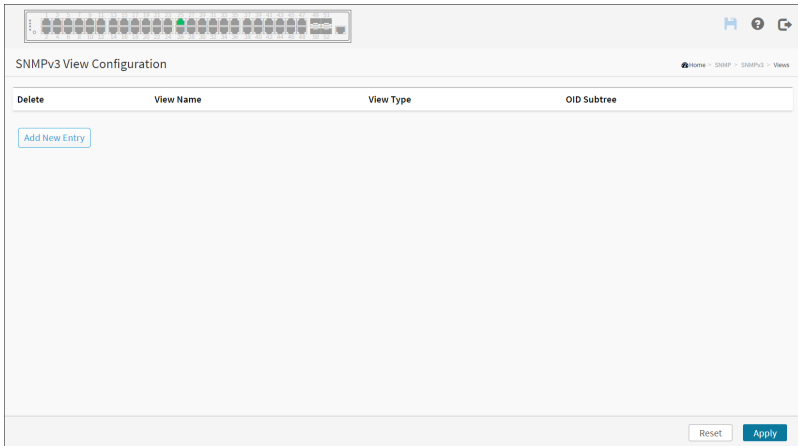

Web Interface

To configure SNMP views in the web interface:

1. Click SNMP, SNMPv3 and Views.
2. Click Add new entry.

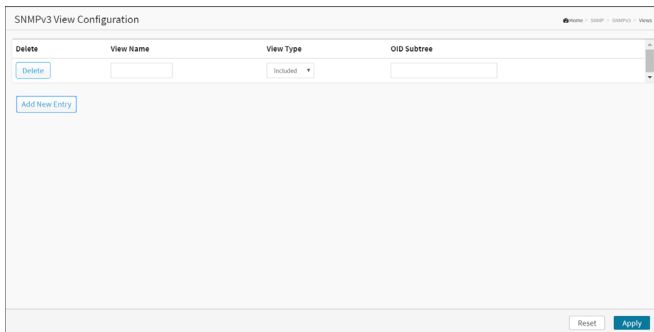

3. Specify the SNMP View parameters.
4. Click Apply.
5. If you want to modify or clear the setting then click Reset.

■ Parameter description:

View Name:

A string identifying the view name that this entry should belong to. The allowed string length is 1 to 31, and the allowed content is ASCII characters from 33 to 126.

View Type:

Indicates the view type that this entry should belong to. Possible view types are:

Included: An optional flag to indicate that this view subtree should be included.

Excluded: An optional flag to indicate that this view subtree should be excluded.

In general, if a view entry's view type is 'excluded', there should be another view entry existing with view type as 'included' and it's OID subtree should overstep the 'excluded' view entry.

OID Subtree:

The OID defining the root of the subtree to add to the named view. The allowed OID length is 1 to 128. The allowed string content is digital number or asterisk(*).

■ Buttons

Add New Entry:

Click to add new entry. Specify the name and configure the new entry. Click "Apply".

Delete:

Check to delete the entry. It will be deleted during the next save.

Apply:

Click to save changes.

Reset:

Click to undo any changes made locally and revert to previously saved values.

Access

The function is used to configure SNMPv3 accesses. The Entry index key are Group Name, Security Model and Security level. To create a new access

account, please check <Add new access> button, and enter the access information then check <Apply>. Max Group Number: 12.

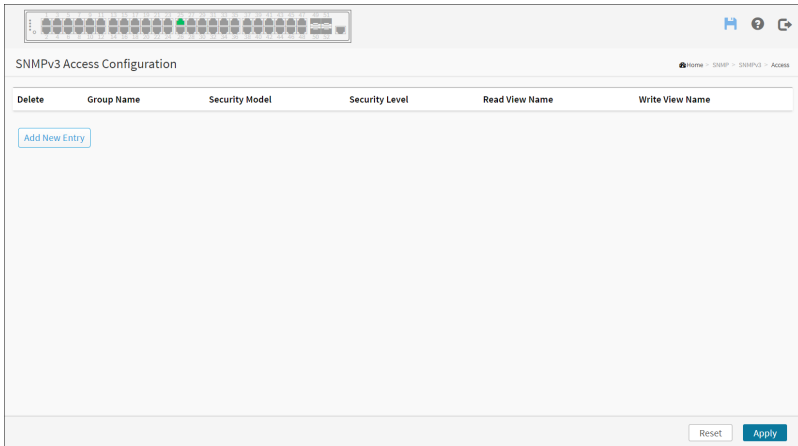

Web Interface

To display the configure SNMP Access in the web interface:

1. Click SNMP, SNMPv3 and Accesses.
2. Click Add new entry.

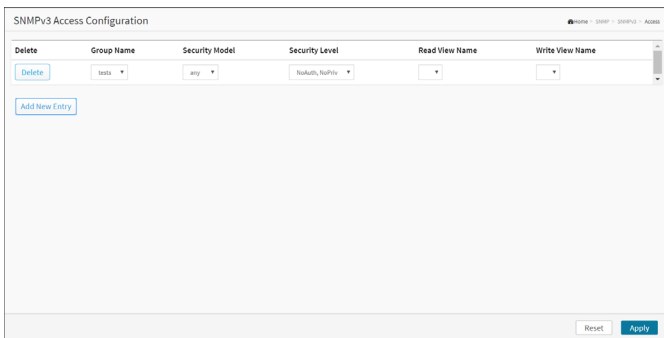

3. Specify the SNMP Access parameters.
4. Click Apply.
5. If you want to modify or clear the setting then click Reset.

■ Parameter description:**Group Name:**

A string identifying the group name that this entry should belong to. The allowed string length is 1 to 31, and the allowed content is ASCII characters from 33 to 126.

Security Model:

Indicates the security model that this entry should belong to. Possible security models are:

Any: Any security model accepted(v1|v2c|usm).

v1: Reserved for SNMPv1.

v2c: Reserved for SNMPv2c.

usm: User-based Security Model (USM).

Security Level:

Indicates the security model that this entry should belong to. Possible security models are:

NoAuth, NoPriv: No authentication and no privacy.

Auth, NoPriv: Authentication and no privacy.

Auth, Priv: Authentication and privacy.

Read View Name:

The name of the MIB view defining the MIB objects for which this request may request the current values. The allowed string length is 1 to 31, and the allowed content is ASCII characters from 33 to 126.

Write View Name:

The name of the MIB view defining the MIB objects for which this request may potentially set new values. The allowed string length is 1 to 31, and the allowed content is ASCII characters from 33 to 126.

■ Buttons**Add New Entry:**

Click to add new entry. Specify the name and configure the new entry. Click “Apply”.

Delete:

Check to delete the entry. It will be deleted during the next save.

Apply:

Click to save changes.

Reset:

Click to undo any changes made locally and revert to previously saved values.

Statics

Configuration

Configure statistics table on this page. The entry index key is ID.

Delete	ID	Data Source
Add New Entry		

Web Interface

To configure the Statistics Configuration in the web interface:

1. Click SNMP, Statics and Configuration.
2. Click Add New Entry.

Delete	ID	Data Source
Delete	<input type="text"/>	.1.3.6.1.2.1.2.2.1.1. 

3. Specify the ID parameters.
4. Click Apply.

■ Parameter description:

These parameters are displayed on the RMON Statistics Configuration page:

ID:

Indicates the index of the entry. The range is from 1 to 65535.

Data Source:

Indicates the port ID which wants to be monitored. If in stacking switch, the value must add 1000*(switch ID-1), for example, if the port is switch 3 port 5, the value is 2005

■ Buttons

Delete:

Check to delete the entry. It will be deleted during the next save.

Add New Entry:

Click to add a new entry.

Apply:

Click to save changes.

Reset:

Click to undo any changes made locally and revert to previously saved values.

Statistics

This page provides an overview of RMON Statistics entries. Each page shows up to 99 entries from the Statistics table, default being 20, selected through the “entries per page” input field. When first visited, the web page will show the first 20 entries from the beginning of the Statistics table. The first displayed will be the one with the lowest ID found in the Statistics table.

The “Start from Control Index” allows the user to select the starting point in the Statistics table. Clicking the Refresh button will update the displayed table starting from that or the next closest Statistics table match.

The Next Entry will use the last entry of the currently displayed entry as a basis for the next lookup. When the end is reached the text “No more entries” is shown in the displayed table. Use the First Entry button to start over.

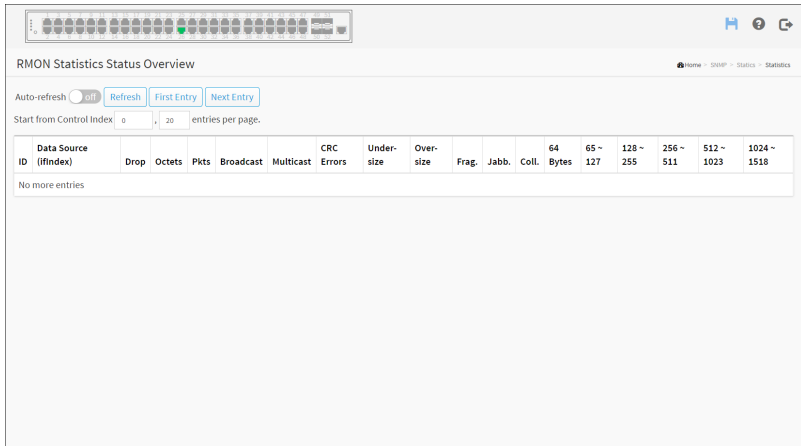

Web Interface

To display a RMON Statistics Status in the web interface:

1. Click SNMP, Statics and Statistics.
2. Specify Port to check.
3. Checked “Auto-refresh”.
4. Click “Refresh” to refresh the port detailed statistics.

■ Parameter description:

ID:

Indicates the index of Statistics entry.

Data Source (if Index):

The port ID which wants to be monitored.

Drop:

The total number of events in which packets were dropped by the probe due to lack of resources.

Octets:

The total number of octets of data (including those in bad packets) received on the network.

Pkts:

The total number of packets (including bad packets, broadcast packets, and multicast packets) received.

Broadcast:

The total number of good packets received that were directed to the broadcast address.

Multicast:

The total number of good packets received that were directed to a multicast address.

CRC Errors:

The total number of packets received that had a length (excluding framing bits, but including FCS octets) of between 64 and 1518 octets, inclusive, but had either a bad Frame Check Sequence (FCS) with an integral number of octets (FCS Error) or a bad FCS with a non-integral number of octets (Alignment Error).

Under-size:

The total number of packets received that were less than 64 octets.

Over-size:

The total number of packets received that were longer than 1518 octets.

Frag.:

The number of frames which size is less than 64 octets received with invalid CRC.

Jabb.:

The number of frames which size is larger than 64 octets received with invalid CRC.

Coll.:

The best estimate of the total number of collisions on this Ethernet segment.

64 Bytes:

The total number of packets (including bad packets) received that were 64 octets in length.

65-127:

The total number of packets (including bad packets) received that were between 65 to 127 octets in length.

128-255:

The total number of packets (including bad packets) received that were between 128 to 255 octets in length.

256-511:

The total number of packets (including bad packets) received that were between 256 to 511 octets in length.

512-1023:

The total number of packets (including bad packets) received that were between 512 to 1023 octets in length.

1024-1588:

The total number of packets (including bad packets) received that were between 1024 to 1588 octets in length.

Search:

You can search for the information that you want to see.

Show entries:

You can choose how many items you want to show.

Buttons



Auto-refresh:

Check this box to refresh the page automatically. Automatic refresh occurs every 3 seconds.

Refresh:

Click to refresh the page immediately.

First Entry:

Updates the table starting from the first entry.

Next Entry:

Updates the table starting with the entry after the last entry currently displayed.

History

Configuration

Configure RMON History table on this page. The entry index key is ID.

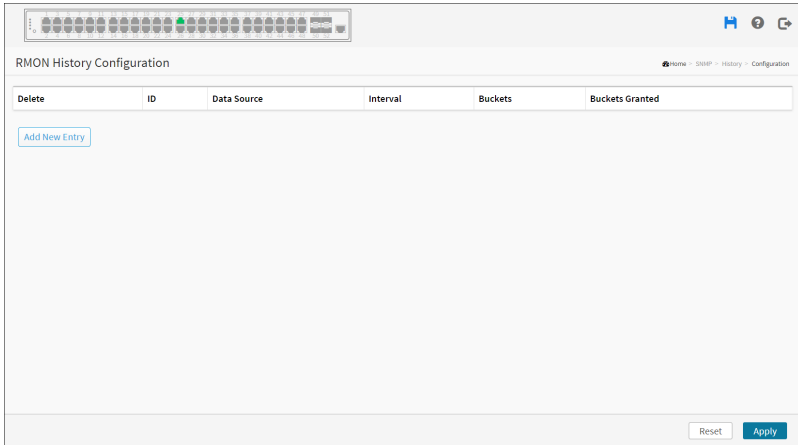

The screenshot shows the 'RMON History Configuration' page in a web browser. At the top, there is a breadcrumb trail: Home > SNMP > History > Configuration. Below the title, there is a table with the following columns: Delete, ID, Data Source, Interval, Buckets, and Buckets Granted. Under the 'Delete' column, there is a 'Delete' button. Below the table, there is an 'Add New Entry' button. At the bottom right of the page, there are 'Reset' and 'Apply' buttons.

Web Interface

To configure the RMON History Configuration in the web interface:

1. Click SNMP, History and Configuration.
2. Click Add New Entry.

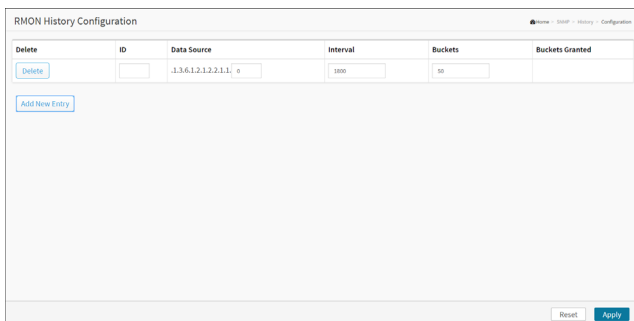

The screenshot shows the 'RMON History Configuration' page with one entry in the table. The entry has the following values: 'Delete' (with a 'Delete' button), 'ID' (empty), 'Data Source' (1.3.6.1.2.1.2.2.1.1), 'Interval' (1000), 'Buckets' (50), and 'Buckets Granted' (empty). Below the table, there is an 'Add New Entry' button. At the bottom right of the page, there are 'Reset' and 'Apply' buttons.

3. Specify the ID parameters.
4. Click Apply.

■ Parameter description:

These parameters are displayed on the RMON History Configuration page:

ID:

Indicates the index of the entry. The range is from 1 to 65535.

Data Source:

Indicates the port ID which wants to be monitored. If in stacking switch, the value must add 1000*(switch ID-1), for example, if the port is switch 3 port 5, the value is 2005.

Interval:

Indicates the interval in seconds for sampling the history statistics data. The range is from 1 to 3600, default value is 1800 seconds.

Buckets:

Indicates the maximum data entries associated this History control entry stored in RMON. The range is from 1 to 3600, default value is 50.

Buckets Granted:

The number of data shall be saved in the RMON.

■ Buttons

Delete:

Check to delete the entry. It will be deleted during the next save.

Add New Entry:

Click to add a new entry.

Apply:

Click to save changes.

Reset:

Click to undo any changes made locally and revert to previously saved values.

Status

This page provides an overview of RMON History entries. Each page shows up to 99 entries from the History table, default being 20, selected through the “entries per page” input field. When first visited, the web page will show the first 20 entries from the beginning of the History table. The first displayed will

be the one with the lowest History Index and Sample Index found in the History table.

The “Start from History Index and Sample Index” allows the user to select the starting point in the History table. Clicking the Refresh button will update the displayed table starting from that or the next closest History table match.

The Next Entry will use the last entry of the currently displayed entry as a basis for the next lookup. When the end is reached the text “No more entries” is shown in the displayed table. Use the First Entry button to start over.

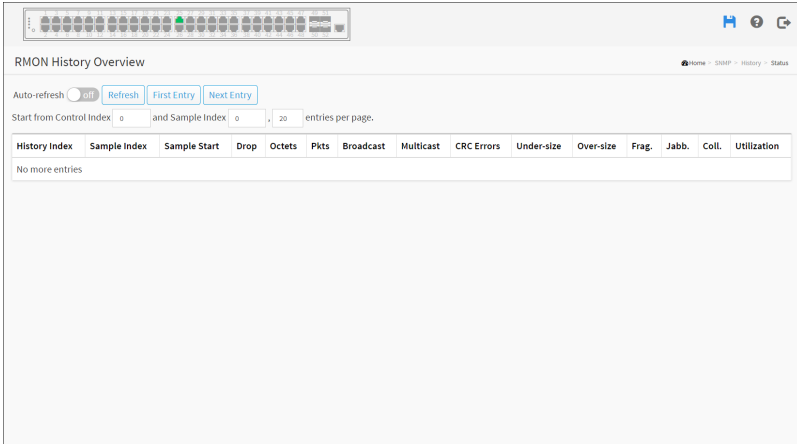

Web Interface

To display a RMON History Status in the web interface:

1. Click SNMP, History and Status.
2. Checked “Auto-refresh”.
3. Click “Refresh” to refresh the port detailed statistics.
4. Click First Entry/Next Entry to change Entry.

■ Parameter description:

History Index:

Indicates the index of History control entry.

Sample Index:

Indicates the index of the data entry associated with the control entry.

Sample Start:

The value of sysUpTime at the start of the interval over which this sample was measured.

Drop:

The total number of events in which packets were dropped by the probe due to lack of resources.

Octets:

The total number of octets of data (including those in bad packets) received on the network.

Pkts:

The total number of packets (including bad packets, broadcast packets, and multicast packets) received.

Broadcast:

The total number of good packets received that were directed to the broadcast address.

Multicast:

The total number of good packets received that were directed to a multicast address.

CRC Errors:

The total number of packets received that had a length (excluding framing bits, but including FCS octets) of between 64 and 1518 octets, inclusive, but had either a bad Frame Check Sequence (FCS) with an integral number of octets (FCS Error) or a bad FCS with a non-integral number of octets (Alignment Error).

Under-size:

The total number of packets received that were less than 64 octets.

Over-size:

The total number of packets received that were longer than 1518 octets.

Frag.:

The number of frames which size is less than 64 octets received with invalid CRC.

Jabb.:

The number of frames which size is larger than 64 octets received with invalid CRC.

Coll.:

The best estimate of the total number of collisions on this Ethernet segment.

Utilization:

The best estimate of the mean physical layer network utilization on this interface during this sampling interval, in hundredths of a percent.

Show entries:

You can choose how many items you want to show.

■ Buttons



Auto-refresh:

Check this box to refresh the page automatically. Automatic refresh occurs every 3 seconds.

Refresh:

Click to refresh the page immediately.

First Entry:

Updates the table starting from the first entry in the IPMC Profile Address Configuration.

Next Entry:

Updates the table, starting with the entry after the last entry currently displayed.

Alarm

Configuration

Configure RMON Alarm table on this page. The entry index key is ID.

RMON Alarm Configuration

Delete	ID	Interval	Variable	Sample Type	Value	Startup Alarm	Rising Threshold	Rising Index	Falling Threshold	Falling Index
Add New Entry										

Reset Apply

Web Interface

To configure the RMON Alarm Configuration in the web interface:

1. Click SNMP, Alarm and Configuration.
2. Click Add New Entry.

RMON Alarm Configuration

Delete	ID	Interval	Variable	Sample Type	Value	Startup Alarm	Rising Threshold	Rising Index	Falling Threshold	Falling Index
Delete	30	30	.1.3.6.1.2.1.2.2.1.0.0	Data	0	Rising/Falling	0	0	0	0

Add New Entry

Reset Apply

3. Specify the ID parameters.
4. Click Apply.

■ Parameter description:

These parameters are displayed on the RMON Alarm Configuration page:

ID:

Indicates the index of the entry. The range is from 1 to 65535.

Interval:

Indicates the interval in seconds for sampling and comparing the rising and falling threshold. The range is from 1 to $2^{31}-1$.

Variables:

Indicates the particular variable to be sampled, the possible variables are:

InOctets:

The total number of octets received on the interface, including framing characters.

InUcastPkts:

The number of uni-cast packets delivered to a higher-layer protocol.

InNUcastPkts:

The number of broad-cast and multi-cast packets delivered to a higher-layer protocol.

InDiscards:

The number of inbound packets that are discarded even the packets are normal.

InErrors:

The number of inbound packets that contained errors preventing them from being deliverable to a higher-layer protocol.

InUnknownProtos:

the number of the inbound packets that were discarded because of the unknown or un-support protocol.

OutOctets:

The number of octets transmitted out of the interface , including framing characters.

OutUcastPkts:

The number of uni-cast packets that request to transmit.

OutNUcastPkts:

The number of broad-cast and multi-cast packets that request to transmit.

OutDiscards:

The number of outbound packets that are discarded event the packets is normal.

OutErrors:

The number of outbound packets that could not be transmitted because of errors.

OutQLen:

The length of the output packet queue (in packets).

Sample Type:

The method of sampling the selected variable and calculating the value to be compared against the thresholds, possible sample types are:

Absolute: Get the sample directly.

Delta: Calculate the difference between samples (default).

Value:

The value of the statistic during the last sampling period.

Startup Alarm:

The method of sampling the selected variable and calculating the value to be compared against the thresholds, possible sample types are:

RisingTrigger alarm when the first value is larger than the rising threshold.

FallingTrigger alarm when the first value is less than the falling threshold.

RisingOrFallingTrigger alarm when the first value is larger than the rising threshold or less than the falling threshold (default).

Rising Threshold:

Rising threshold value (-2147483648-2147483647).

Rising Index:

Rising event index (1-65535).

Falling Threshold:

Falling threshold value (-2147483648-2147483647)

Falling Index:

Falling event index (1-65535).

■ Buttons**Delete:**

Check to delete the entry. It will be deleted during the next save.

Add New Entry:

Click to add a new entry.

Apply:

Click to save changes.

Reset:

Click to undo any changes made locally and revert to previously saved values.

Status

This page provides an overview of RMON Alarm entries. Each page shows up to 99 entries from the Alarm table, default being 20, selected through the “entries per page” input field. When first visited, the web page will show the first 20 entries from the beginning of the Alarm table. The first displayed will be the one with the lowest ID found in the Alarm table.

The “Start from Control Index” allows the user to select the starting point in the Alarm table. Clicking the Refresh button will update the displayed table starting from that or the next closest Alarm table match.

The Next Entry will use the last entry of the currently displayed entry as a basis for the next lookup. When the end is reached the text “No more entries” is shown in the displayed table. Use the First Entry button to start over.

RMON Alarm Overview

Auto-refresh Refresh First Entry Next Entry

Start from Control Index: 0 entries per page: 20

ID	Interval	Variable	Sample Type	Value	Startup Alarm	Rising Threshold	Rising Index	Falling Threshold	Falling Index
No more entries									

Web Interface

To display a RMON Alarm Status in the web interface:

1. Click SNMP, Alarm and Status.

2. Checked “Auto-refresh”.
3. Click “Refresh” to refresh the port detailed statistics.
4. Click First Entry/Next Entry to change Entry.

■ **Parameter description:**

ID:

Indicates the index of Alarm control entry.

Interval:

Indicates the interval in seconds for sampling and comparing the rising and falling threshold.

Variable:

Indicates the particular variable to be sampled

Sample Type:

The method of sampling the selected variable and calculating the value to be compared against the thresholds.

Value:

The value of the statistic during the last sampling period.

Startup Alarm:

The alarm that may be sent when this entry is first set to valid.

Rising Threshold:

Rising threshold value.

Rising Index:

Rising event index.

Falling Threshold:

Falling threshold value.

Falling Index:

Falling event index.

Show entries:

You can choose how many items you want to show.

Buttons



Auto-refresh:

Check this box to refresh the page automatically. Automatic refresh occurs every 3 seconds.

Refresh:

Click to refresh the page immediately.

First Entry:

Updates the table starting from the first entry in the IPMC Profile Address Configuration.

Next Entry:

Updates the table, starting with the entry after the last entry currently displayed.

Event

Configuration

Configure RMON Event table on this page. The entry index key is **ID**.

The screenshot shows the 'RMON Event Configuration' page. At the top, there is a breadcrumb trail: Home > SNMP > Event > Configuration. Below this is a table with the following columns: Delete, ID, Desc, Type, and Event Last Time. The table is currently empty. Below the table, there is a button labeled 'Add New Entry'. At the bottom right of the page, there are 'Reset' and 'Apply' buttons.

Web Interface

To configure the RMON Event Configuration in the web interface:

1. Click SNMP, Event and Configuration.
2. Click Add New Entry.

The screenshot shows the 'RMON Event Configuration' page with the 'Add New Entry' form. The form has the following fields: 'Delete' (a button), 'ID' (a text input field), 'Desc' (a text input field), 'Type' (a dropdown menu set to 'none'), and 'Event Last Time' (a text input field set to '0'). Below the form, there is a button labeled 'Add New Entry'. At the bottom right of the page, there are 'Reset' and 'Apply' buttons.

3. Specify the ID parameters.
4. Click Apply.

■ **Parameter description:**

These parameters are displayed on the RMON History Configuration page:

ID:

Indicates the index of the entry. The range is from 1 to 65535.

Desc:

Indicates this event, the string length is from 0 to 127, default is a null string.

Type:

Indicates the notification of the event, the possible types are:

None: No SNMP log is created, no SNMP trap is sent.

Log: Create SNMP log entry when the event is triggered.

Snmp trap: Send SNMP trap when the event is triggered.

Log and trap: Create SNMP log entry and sent SNMP trap when the event is triggered.

Event Last Time:

Indicates the value of sysUpTime at the time this event entry last generated an event.

■ **Buttons**

Delete:

Check to delete the entry. It will be deleted during the next save.

Add New Entry:

Click to add a new entry.

Apply:

Click to save changes.

Reset:

Click to undo any changes made locally and revert to previously saved values.

Status

This page provides an overview of RMON Event table entries. Each page shows up to 99 entries from the Event table, default being 20, selected through the “entries per page” input field. When first visited, the web page will show the first 20 entries from the beginning of the Event table. The first displayed

will be the one with the lowest Event Index and Log Index found in the Event table.

The “Start from Event Index and Log Index” allows the user to select the starting point in the Event table. Clicking the Refresh button will update the displayed table starting from that or the next closest Event table match.

The Next Entry will use the last entry of the currently displayed entry as a basis for the next lookup. When the end is reached the text “No more entries” is shown in the displayed table. Use the First Entry button to start over.

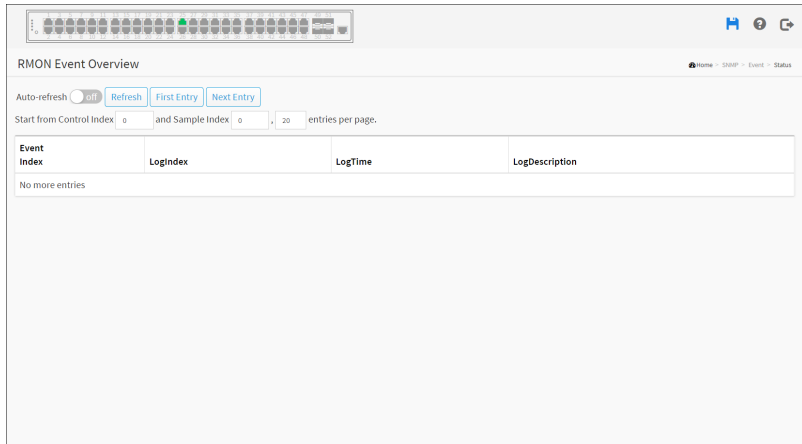

Web Interface

To display a RMON Event Status in the web interface:

1. Click SNMP, Event and Status.
2. Checked “Auto-refresh”.
3. Click “Refresh” to refresh the port detailed statistics.
4. Click First Entry/Next Entry to change Entry.

■ Parameter description:

Event Index:

Indicates the index of the event entry.

Log Index:

Indicates the index of the log entry.

LogTime:

Indicates Event log time

LogDescription:

Indicates the Event description.

Show entries:

You can choose how many items you want to show.

■ Buttons



Auto-refresh:

Check this box to refresh the page automatically. Automatic refresh occurs every 3 seconds.

Refresh:

Click to refresh the page immediately.

First Entry:

Updates the table starting from the first entry in the IPMC Profile Address Configuration.

Next Entry:

Updates the table, starting with the entry after the last entry currently displayed.

Chapter 15

Event Notification

Overview

The menu and the submenu are shown below:

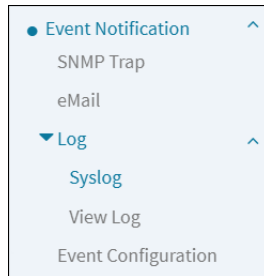
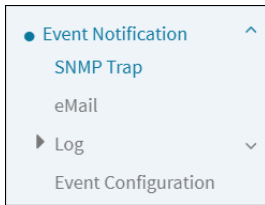

SNMP Trap

Configure Trap on this page.

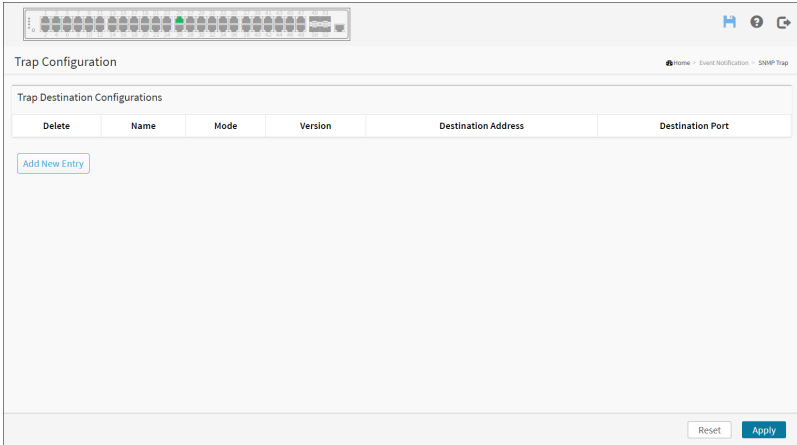

Web Interface

To configure SNMP Trap Configuration in the web interface:

1. Click Event Notification and SNMP Trap.
2. Click Add New Entry then you can create new SNMP Trap on the switch.

3. Specify SNMP Trap parameter.
4. Click Apply.

■ Parameter description:**Trap Destination Configurations**

Name:

Indicates the trap Configuration's name. Indicates the trap destination's name.

Enable:

Indicates the trap destination mode operation. Possible modes are:

Enabled: Enable SNMP trap mode operation.

Disabled: Disable SNMP trap mode operation.

Version:

Indicates the SNMP trap supported version. Possible versions are:

SNMPv1: Set SNMP trap supported version 1.

SNMPv2c: Set SNMP trap supported version 2c.

SNMPv3: Set SNMP trap supported version 3.

Destination Address:

Indicates the SNMP trap destination address. It allow a valid IP address in dotted decimal notation ('x.y.z.w').

And it also allow a valid hostname. A valid hostname is a string drawn from the alphabet (A-Za-z), digits (0-9), dot (.), dash (-). Spaces are not allowed, the first character must be an alpha character, and the first and last characters must not be a dot or a dash.

Indicates the SNMP trap destination IPv6 address. IPv6 address is in 128-bit records represented as eight fields of up to four hexadecimal digits with a colon separating each field (:). For example, 'fe80::215:c5ff:fe03:4dc7'. The symbol '::' is a special syntax that can be used as a shorthand way of representing multiple 16-bit groups of contiguous zeros; but it can appear only once. It can also represent a legally valid IPv4 address. For example, '::192.1.2.34'.

Destination port:

Indicates the SNMP trap destination port. SNMP Agent will send SNMP message via this port, the port range is 1~65535.

SNMP Trap Configuration

Trap Config Name:

Indicates which trap Configuration's name for configuring. The allowed string length is 1 to 32, and the allowed content is ASCII characters from 33 to 126.

Trap Mode:

Indicates the SNMP mode operation. Possible modes are:

on: Enable SNMP mode operation.

off: Disable SNMP mode operation.

Trap Version:

Indicates the SNMP supported version. Possible versions are:

SNMP v1: Set SNMP supported version 1.

SNMP v2c: Set SNMP supported version 2c.

SNMP v3: Set SNMP supported version 3.

Trap Community:

Indicates the community access string when sending SNMP trap packet. The allowed string length is 0 to 63, and the allowed content is ASCII characters from 33 to 126.

Trap Destination Address:

Indicates the SNMP trap destination address. It allow a valid IP address in dotted decimal notation ('x.y.z.w').

And it also allow a valid hostname. A valid hostname is a string drawn from the alphabet (A-Za-z), digits (0-9), dot (.), dash (-). Spaces are not allowed, the first character must be an alpha character, and the first and last characters must not be a dot or a dash.

Indicates the SNMP trap destination IPv6 address. IPv6 address is in 128-bit records represented as eight fields of up to four hexadecimal digits with a colon separating each field (:). For example, 'fe80::215:c5ff:fe03:4dc7'. The symbol '::' is a special syntax that can be used as a shorthand way of representing multiple 16-bit groups of contiguous zeros; but it can appear only once. It can also represent a legally valid IPv4 address. For example, '::192.1.2.34'.

Trap Destination port:

Indicates the SNMP trap destination port. SNMP Agent will send SNMP message via this port, the port range is 1~65535.

Trap Security Engine ID:

Indicates the SNMP trap security engine ID. SNMPv3 sends traps and informs using USM for authentication and privacy. A unique engine ID for these traps and informs is needed. When "Trap Probe Security Engine ID" is enabled, the ID will be probed automatically. Otherwise, the ID specified in this field is

used. The string must contain an even number(in hexadecimal format) with number of digits between 10 and 64, but all-zeros and all-'F's are not allowed.

Trap Security Name:

Indicates the SNMP trap security name. SNMPv3 traps and informs using USM for authentication and privacy. A unique security name is needed when traps and informs are enabled.

■ **Buttons**

Add New Entry:

Click to add a new entry.

Apply:

Click to save changes.

Reset:

Click to undo any changes made locally and revert to previously saved values.

eMail

Configure SMTP (Simple Mail Transfer Protocol) on this page. Simple Mail Transfer Protocol is the message-exchange standard for the Internet.

The Switch is to be configured as a client of SMTP while the server is a remote device that will receive messages from the switch that alarm events occurred.

SMTP Configuration	
Mail Server	<input type="text"/>
User Name	<input type="text"/>
Password	<input type="text"/>
Sender	<input type="text"/>
Return Path	<input type="text"/>
Email Address 1	<input type="text"/>
Email Address 2	<input type="text"/>
Email Address 3	<input type="text"/>
Email Address 4	<input type="text"/>
Email Address 5	<input type="text"/>
Email Address 6	<input type="text"/>

Reset Apply

Web Interface

To configure SMTP Configuration in the web interface:

1. Click Event Notification and eMail.
2. Specify SMTP Configuration parameter.
3. Click Apply.

■ Parameter description:

Mail Server:

The IP address or hostname of the mail server. IP address is expressed in dotted decimal notation. This will be the device that sends out the mail for you

User Name:

Specify the username on the mail server.

Password:

Specify the password of the user on the mail server.

Sender:

Specify the sender name of the alarm mail.

Return Path:

Specify the sender email address of the alarm mail. This address will be the “from” address on the email message.

Email Address #:

Specify the email address of the receiver.

■ **Buttons**

Apply:

Click to save changes.

Reset:

Click to undo any changes made locally and revert to previously saved values.

Log

Syslog

The Syslog Configuration is a standard for logging program messages. It allows separation of the software that generates messages from the system that stores them and the software that reports and analyzes them. It can be used as well a generalized informational, analysis and debugging messages. It is supported by a wide variety of devices and receivers across multiple platforms.

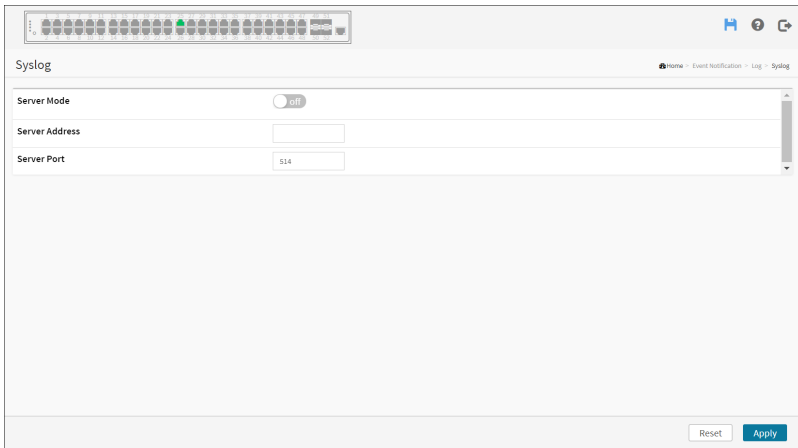

Web Interface

To configure Syslog Configuration in the web interface:

1. Click Event Notification, Log and Syslog.
2. Evoke the Server Mode to enable it.
3. Specify the syslog parameters include Server Address and Server Port.
4. Click Apply.

■ Parameter description:

Server Mode:

Indicates the server mode operation. When the mode operation is enabled, the syslog message will send out to syslog server. The syslog protocol is based on UDP communication and received on UDP port 514 and the syslog server will not send acknowledgments back sender since UDP is a connectionless protocol and it does not provide acknowledgments. The syslog packet will always send

out even if the syslog server does not exist. Possible modes are:

Enabled: Enable server mode operation.

Disabled: Disable server mode operation.

Server Address:

Indicates the IPv4 host address of syslog server. If the switch provide DNS feature, it also can be a domain name.

Server Port:

Indicates the service port of syslog server.

■ Buttons

Apply:

Click to save changes.

Reset:

Click to undo any changes made locally and revert to previously saved values.

View Log

This section describes that display the system log information of the switch

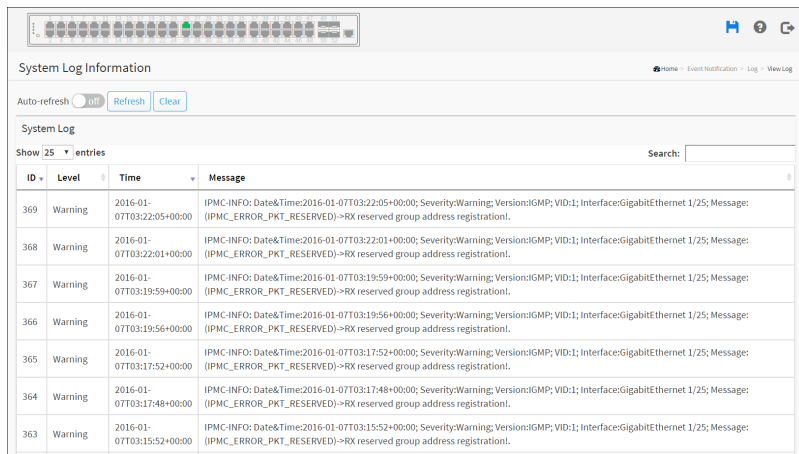

The screenshot shows the 'System Log Information' page in a web interface. At the top, there is a navigation bar with 'Home', 'Event Notification', 'Log', and 'View Log'. Below the navigation bar, there are 'Auto-refresh' (off) and 'Refresh' buttons, and a 'Clear' button. The main content area is titled 'System Log' and shows 'Show 25 entries'. A search box is present on the right. The log entries are displayed in a table with columns for ID, Level, Time, and Message.

ID	Level	Time	Message
369	Warning	2016-01-07T03:22:05+00:00	IPMC-INFO: Date&Time:2016-01-07T03:22:05+00:00; Severity:Warning; Version:IGMP; VID:1; Interface:GigabitEthernet 1/25; Message: (IPMC_ERROR_PKT_RESERVED)->RX reserved group address registration.
368	Warning	2016-01-07T03:22:01+00:00	IPMC-INFO: Date&Time:2016-01-07T03:22:01+00:00; Severity:Warning; Version:IGMP; VID:1; Interface:GigabitEthernet 1/25; Message: (IPMC_ERROR_PKT_RESERVED)->RX reserved group address registration.
367	Warning	2016-01-07T03:19:59+00:00	IPMC-INFO: Date&Time:2016-01-07T03:19:59+00:00; Severity:Warning; Version:IGMP; VID:1; Interface:GigabitEthernet 1/25; Message: (IPMC_ERROR_PKT_RESERVED)->RX reserved group address registration.
366	Warning	2016-01-07T03:19:56+00:00	IPMC-INFO: Date&Time:2016-01-07T03:19:56+00:00; Severity:Warning; Version:IGMP; VID:1; Interface:GigabitEthernet 1/25; Message: (IPMC_ERROR_PKT_RESERVED)->RX reserved group address registration.
365	Warning	2016-01-07T03:17:52+00:00	IPMC-INFO: Date&Time:2016-01-07T03:17:52+00:00; Severity:Warning; Version:IGMP; VID:1; Interface:GigabitEthernet 1/25; Message: (IPMC_ERROR_PKT_RESERVED)->RX reserved group address registration.
364	Warning	2016-01-07T03:17:48+00:00	IPMC-INFO: Date&Time:2016-01-07T03:17:48+00:00; Severity:Warning; Version:IGMP; VID:1; Interface:GigabitEthernet 1/25; Message: (IPMC_ERROR_PKT_RESERVED)->RX reserved group address registration.
363	Warning	2016-01-07T03:15:52+00:00	IPMC-INFO: Date&Time:2016-01-07T03:15:52+00:00; Severity:Warning; Version:IGMP; VID:1; Interface:GigabitEthernet 1/25; Message: (IPMC_ERROR_PKT_RESERVED)->RX reserved group address registration.

Web Interface

To display the log Information in the web interface:

1. Click Event Notification, Log and View Log.
2. Display the log information.

■ **Parameter description:**

ID:

ID (≥ 1) of the system log entry.

Level:

level of the system log entry. The following level types are supported:

Debug: debug level message.

Info: informational message.

Notice: normal, but significant, condition.

Warning: warning condition.

Error: error condition.

Crit: critical condition.

Alert: action must be taken immediately.

Emerg: system is unusable.

Time:

It will display the log record by device time. The time of the system log entry.

Message:

It will display the log detail message. The message of the system log entry.

Search:

You can search for the information that you want to see.

Show entries:

You can choose how many items you want to show.

■ **Buttons**

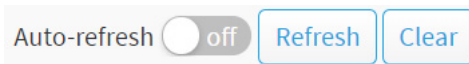

Auto-refresh:

Check this box to refresh the page automatically. Automatic refresh occurs every 3 seconds.

Refresh:

Click to refresh the page.

Clear:

Click to clear the page.

Event Configuration

This page displays current trap event severity configurations. Trap event severity can also be configured here.

Group Name	Severity Level	Syslog	Trap	SMTP
ACL	Info	<input checked="" type="checkbox"/>	<input type="checkbox"/>	<input type="checkbox"/>
ACL-Log	Info	<input checked="" type="checkbox"/>	<input type="checkbox"/>	<input type="checkbox"/>
Access-Mgmt	Info	<input checked="" type="checkbox"/>	<input type="checkbox"/>	<input type="checkbox"/>
Auth-Failed	Warning	<input checked="" type="checkbox"/>	<input type="checkbox"/>	<input type="checkbox"/>
Cold-Start	Warning	<input checked="" type="checkbox"/>	<input type="checkbox"/>	<input type="checkbox"/>
Config-Info	Info	<input checked="" type="checkbox"/>	<input type="checkbox"/>	<input type="checkbox"/>
DMS	Info	<input checked="" type="checkbox"/>	<input type="checkbox"/>	<input type="checkbox"/>
FAN	Info	<input checked="" type="checkbox"/>	<input type="checkbox"/>	<input type="checkbox"/>
Firmware-Upgrade	Info	<input checked="" type="checkbox"/>	<input type="checkbox"/>	<input type="checkbox"/>
Import-Export	Info	<input checked="" type="checkbox"/>	<input type="checkbox"/>	<input type="checkbox"/>
LACP	Info	<input checked="" type="checkbox"/>	<input type="checkbox"/>	<input type="checkbox"/>

Web Interface

To display the configure Trap Event Severity in the web interface:

1. Click Event Notification and Event Configuration.
2. Scroll to select the Group name and Severity Level.
3. Click Enable to select different trap event.
4. Click the Apply to save the setting.
5. If you want to cancel the setting then you need to click the Reset button. It will revert to previously saved values.

■ Parameter description:

Group Name:

The name identifying the severity group.

Severity Level:

Every group has an severity level. The following level types are supported:

- <0> Emergency: System is unusable.
- <1> Alert: Action must be taken immediately.
- <2> Critical: Critical conditions.
- <3> Error: Error conditions.

<4> Warning: Warning conditions.

<5> Notice: Normal but significant conditions.

<6> Information: Information messages.

<7> Debug: Debug-level messages.

Syslog:

Enable - Select this Group Name in Syslog.

Trap:

Enable - Select this Group Name in Trap.

Switch2go:

Enable - Select this Group Name in Push Notification.

■ Buttons

Apply:

Click to save changes.

Reset:

Click to undo any changes made locally and revert to previously saved values.

This Page Intentionally Left Blank

Chapter 16

Diagnostics

Overview

This chapter provides a set of basic system diagnosis. These include ping, trace-route, cable diagnostics and port mirroring.

The menu and the submenu are shown below:

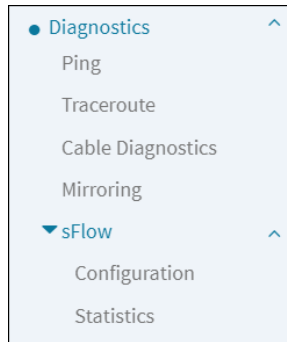
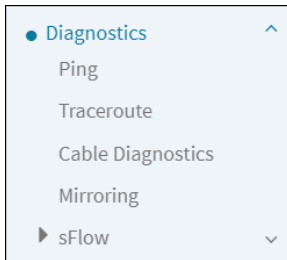

Ping

This section allows you to issue ICMP Echo packets to troubleshoot Ipv4/6 connectivity issues.

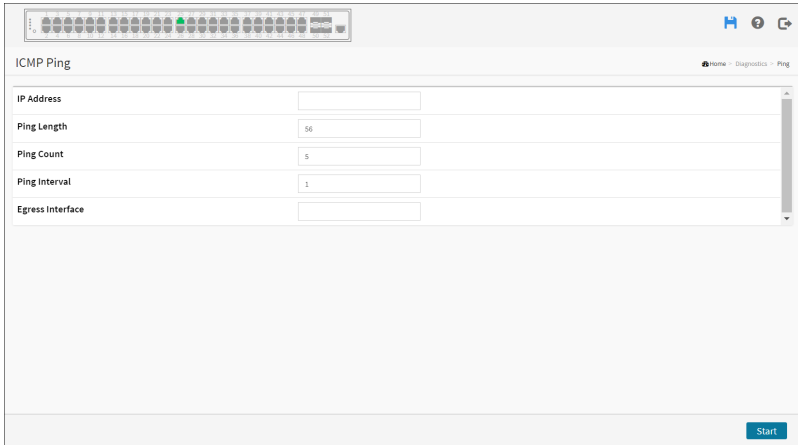

The screenshot displays the 'ICMP Ping' configuration page. At the top, there is a navigation bar with a home icon, a help icon, and a refresh icon. Below the navigation bar, the page title 'ICMP Ping' is shown on the left, and a breadcrumb trail 'Home > Diagnostics > Ping' is on the right. The main content area contains five input fields: 'IP Address' (empty), 'Ping Length' (56), 'Ping Count' (5), 'Ping Interval' (1), and 'Egress Interface' (empty). A 'Start' button is located at the bottom right of the form.

Web Interface

To configure a PING in the web interface:

1. Click Diagnostics and Ping.
2. Specify IP Address, Ping Length, Ping Count, Ping Interval and Egress Interface.
3. Click Start.

■ Parameter description:

IP Address:

To specify the target IP Address of the Ping.

Ping Length:

The payload size of the ICMP packet. Values range from 2 bytes to 1452 bytes.

Ping Count:

The count of the ICMP packet. Values range from 1 time to 60 times.

Ping Interval:

The interval of the ICMP packet. Values range from 0 second to 30seconds.

Egress Interface (Only for IPv6):

The VLAN ID (VID) of the specific egress IPv6 interface which ICMP packet goes.

The given VID ranges from 1 to 4094 and will be effective only when the corresponding IPv6 interface is valid.

When the egress interface is not given, PING6 finds the best match interface for destination.

Do not specify egress interface for loopback address.

Do specify egress interface for link-local or multicast address.

■ **Buttons**

Start:

Click the “Start” button to start to ping the target IP Address.

New Ping:

Back to ICMP Ping page.

Traceroute

This page allows you to issue ICMP, TCP, or UDP packets to diagnose network connectivity issues.

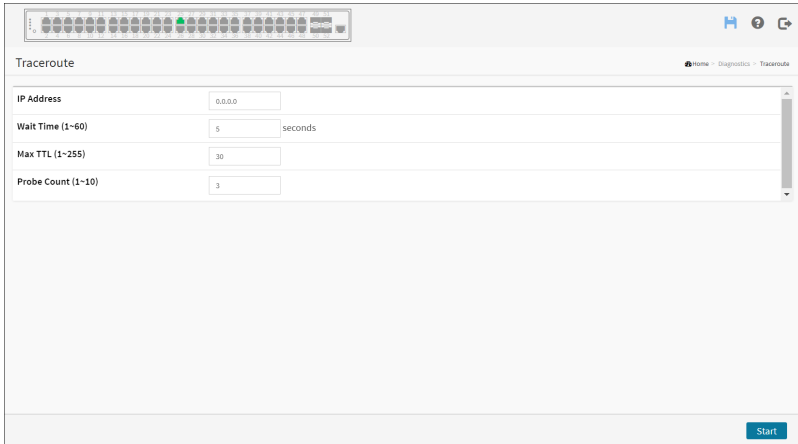

The screenshot shows the Traceroute web interface. At the top, there is a navigation bar with a home icon, a question mark, and a refresh icon. Below the navigation bar, the title "Traceroute" is displayed. The main content area contains four input fields: "IP Address" with the value "0.0.0.0", "Wait Time (1-60)" with the value "5" and the unit "seconds", "Max TTL (1-255)" with the value "30", and "Probe Count (1-10)" with the value "3". A "Start" button is located at the bottom right of the form.

Web Interface

To start a Traceroute in the web interface:

1. Click Diagnostics and Traceroute.
2. Specify IP Address, Wait Time, Max TTL and Probe Count.
3. Click Start.



The screenshot shows the Traceroute web interface displaying the results of a traceroute. The text in the results area reads: "traceroute to 0.0.0.0 (0.0.0.0), 30 hops max, 38 byte packets" and "1 localhost (127.0.0.1) 0.143 ms 0.115 ms 0.100 ms". A "New Traceroute" button is located at the bottom right of the results area.

■ Parameter description:

IP Address:

The destination IP Address.

Wait Time:

Set the time (in seconds) to wait for a response to a probe (default 5.0 sec). Values range from 1 to 60. The payload size of the ICMP packet. Values range from 2 bytes to 1452 bytes.

Max TTL:

Specifies the maximum number of hops (max time-to-live value) traceroute will probe. Values range from 1 to 255. The default is 30.

Probe Count:

Sets the number of probe packets per hop. Values range from 1 to 10. The default is 3.

■ **Buttons**

Start:

Click the “Start” button to start to traceroute the target IP Address.

New Traceroute:

[Back to Traceroute page.](#)

Cable Diagnostics

This section shows how to run Cable Diagnostics for copper ports.

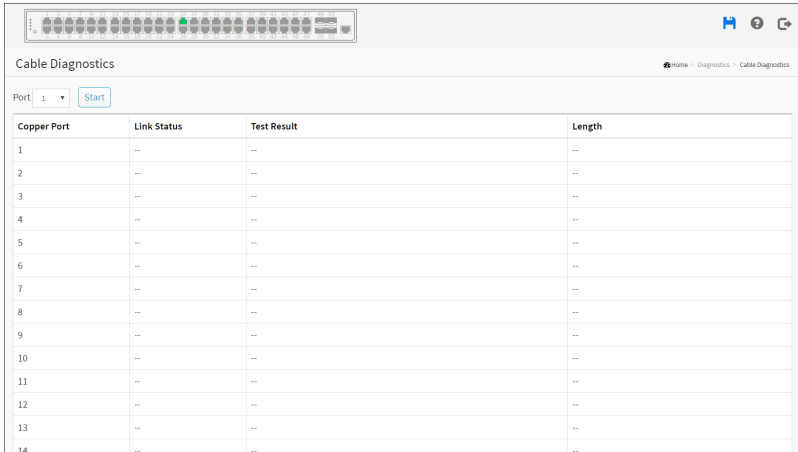

Web Interface

To configure a Cable Diagnostics Configuration in the web interface:

1. Click Diagnostics and Cable Diagnostics.
2. Specify Port which want to check.
3. Click Start.

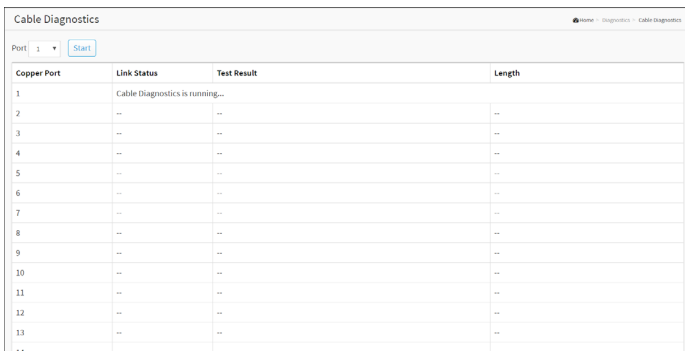

■ Parameter description:

Port:

The port where you are requesting Cable Diagnostics.

Copper Port:

Copper port number.

Link Status:

The status of the cable.

10M: Cable is link up and correct. Speed is 10Mbps

100M: Cable is link up and correct. Speed is 100Mbps

1G: Cable is link up and correct. Speed is 1Gbps

Link Down: Link down or cable is not correct.

Test Result:

Test Result of the cable.

OK: Correctly terminated pair

Abnormal: Incorrectly terminated pair or link down

Length:

The length (in meters) of the cable pair. The resolution is 3 meters. When Link Status is shown as follow, the length has different definition.

1G: The length is the minimum value of 4-pair.

10M/100M: The length is the minimum value of 2-pair.

Link Down: The length is the minimum value of non-zero of 4-pair.

■ Button

Start:

Start to cable diagnostics the port that you selected.

Mirroring

You can mirror traffic from any source port to a target port for real-time analysis. You can then attach a logic analyzer or RMON probe to the target port and study the traffic crossing the source port in a completely unobtrusive manner.

Mirror Configuration is to monitor the traffic of the network. For example, we assume that Port A and Port B are Monitoring Port and Monitored Port respectively, thus, the traffic received by Port B will be copied to Port A for monitoring.

Mirror Configuration

Monitor Session: 1

Monitor destination port: Disabled

Monitor Source Port Configuration

Port	Mode
<>	<>
1	Disabled
2	Disabled
3	Disabled
4	Disabled
5	Disabled
6	Disabled
7	Disabled

Reset Apply

Web Interface

To configure the Port Mirror function in the web interface:

1. Click Diagnostics and Mirroring.
2. Select the Monitor Destination Port (Mirror Port).
3. Select mode (disabled, enable, TX Only and RX only) for each monitored port.
4. Click the Apply button to save the setting.
5. If you want to cancel the setting then you need to click the Reset button to revert to previously saved values.

■ Parameter description:

Monitor Destination Port:

Port to output the mirrored traffic. Also known as the mirror port. Frames from ports that have either source (rx) or destination (tx) mirroring enabled are mirrored on this port.

Mirror Source Port Configuration

The following table is used for Rx and Tx enabling.

Port:

The logical port for the settings contained in the same row.

Mode:

Select mirror mode.

Rx only: Frames received on this port are mirrored on the mirror port. Frames transmitted are not mirrored.

Tx only: Frames transmitted on this port are mirrored on the mirror port. Frames received are not mirrored.

Disabled: neither frames transmitted nor frames received are mirrored.

Enabled: Frames received and frames transmitted are mirrored on the mirror port.

■ Buttons

Apply:

Click to save changes.

Reset:

Click to undo any changes made locally and revert to previously saved values.

sFlow

Configuration

The sFlow Collector configuration for the switch can be monitored and modified here. The configuration is divided into two parts: Configuration of the sFlow receiver (a.k.a. sFlow collector) and configuration of per-port flow and counter samplers.

sFlow configuration is not persisted to non-volatile memory, which means that a reboot or master change will disable sFlow sampling.

sFlow Configuration

Home > Diagnostics > sFlow > Configuration

Agent Configuration

IP Address: 127.0.0.1

Receiver Configuration

Owner: <none> [Release]

IP Address/Hostname: 0.0.0.0

UDP Port: 6343

Timeout: 0 seconds

Max. Datagram Size: 1400 bytes

Port Configuration

Port	Flow Sampler			Counter Poller	
	Enabled	Sampler Type	Sampling Rate	Enabled	Interval
*	<input type="checkbox"/>	<>	0	<input type="checkbox"/>	0
1	<input type="checkbox"/>	Tx	0	<input type="checkbox"/>	0
2	<input type="checkbox"/>	Tx	0	<input type="checkbox"/>	0
3	<input type="checkbox"/>	Tx	0	<input type="checkbox"/>	0
4	<input type="checkbox"/>	Tx	0	<input type="checkbox"/>	0
5	<input type="checkbox"/>	Tx	0	<input type="checkbox"/>	0
6	<input type="checkbox"/>	Tx	0	<input type="checkbox"/>	0
7	<input type="checkbox"/>	Tx	0	<input type="checkbox"/>	0
8	<input type="checkbox"/>	Tx	0	<input type="checkbox"/>	0
9	<input type="checkbox"/>	Tx	0	<input type="checkbox"/>	0
10	<input type="checkbox"/>	Tx	0	<input type="checkbox"/>	0

Reset Apply

Web Interface

To configure the sFlow in the web interface:

1. Click Diagnostics, sFlow and Configuration.
2. Set the sFlow parameters.

3. Click apply to save the setting.
4. If you want to cancel the setting then you need to click the Reset button. It will revert to previously saved values.

■ Parameter description:

Agent Configuration

IP Address:

The IP address used as Agent IP address in sFlow datagrams. It serves as a unique key that will identify this agent over extended periods of time.

Both IPv4 and IPv6 addresses are supported.

Receiver Configuration

Owner:

Basically, sFlow can be configured in two ways: Through local management using the Web or CLI interface or through SNMP. This read-only field shows the owner of the current sFlow configuration and assumes values as follows:

- If sFlow is currently unconfigured/unclaimed, Owner contains <none>.
- If sFlow is currently configured through Web or CLI, Owner contains <Configured through local management>.
- If sFlow is currently configured through SNMP, Owner contains a string identifying the sFlow receiver.

If sFlow is configured through SNMP, all controls - except for the Release-button - are disabled to avoid inadvertent reconfiguration.

The Release button allows for releasing the current owner and disable sFlow sampling. The button is disabled if sFlow is currently unclaimed. If configured through SNMP, the release must be confirmed (a confirmation request will appear).

IP Address/Hostname:

The IP address or hostname of the sFlow receiver. Both IPv4 and IPv6 addresses are supported.

UDP Port:

The UDP port on which the sFlow receiver listens to sFlow datagrams. If set to 0 (zero), the default port (6343) is used.

Timeout:

The number of seconds remaining before sampling stops and the current sFlow owner is released. While active, the current time left can be updated with a

click on the Refresh-button. If locally managed, the timeout can be changed on the fly without affecting any other settings.

Max. Datagram Size:

The maximum number of data bytes that can be sent in a single sample datagram. This should be set to a value that avoids fragmentation of the sFlow datagrams. Valid range is 200 to 1468 bytes with default being 1400 bytes.

Port Configuration

Port:

The port number for which the configuration below applies.

Flow Sampler Enabled:

Enables/disables flow sampling on this port.

Flow Sampler Sampling Rate:

The statistical sampling rate for packet sampling. Set to N to sample on average 1/Nth of the packets transmitted/received on the port.

Not all sampling rates are achievable. If an unsupported sampling rate is requested, the switch will automatically adjust it to the closest achievable. This will be reported back in this field.

Flow Sampler Max. Header:

The maximum number of bytes that should be copied from a sampled packet to the sFlow datagram. Valid range is 14 to 200 bytes with default being 128 bytes.

If the maximum datagram size does not take into account the maximum header size, samples may be dropped.

Counter Poller Enabled:

Enables/disables counter polling on this port.

Counter Poller Interval:

With counter polling enabled, this specifies the interval - in seconds - between counter poller samples.

■ Buttons

Apply:

Click to save changes.

Reset:

Click to undo any changes made locally and revert to previously saved values.

Release:

See description under Owner.

Refresh:

Click to refresh the page. Note that unsaved changes will be lost.

Statistics

This session shows receiver and per-port sFlow statistics

Receiver Statistics	
Owner	<none>
IP Address/Hostname	0.0.0.0
Timeout	0
Tx Successes	0
Tx Errors	0
Flow Samples	0
Counter Samples	0

Port Statistics			
Port	Rx Flow Samples	Tx Flow Samples	Counter Samples
1	0	0	0
2	0	0	0
3	0	0	0
4	0	0	0

Web Interface

To Display port sFlow statistics in the web interface:

1. Click Diagnostics, sFlow and statistics.
2. Display sFlow information.

■ Parameter description:

Receiver Statistics

Owner:

This field shows the current owner of the sFlow configuration. It assumes one of three values as follows:

- If sFlow is currently unconfigured/unclaimed, Owner contains <none>.
- If sFlow is currently configured through Web or CLI, Owner contains <Configured through local management>.

- If sFlow is currently configured through SNMP, Owner contains a string identifying the sFlow receiver.`

IP Address/Hostname:

The IP address or hostname of the sFlow receiver.

Timeout:

The number of seconds remaining before sampling stops and the current sFlow owner is released.

Tx Successes:

The number of UDP datagrams successfully sent to the sFlow receiver.

Tx Errors:

The number of UDP datagrams that has failed transmission.

The most common source of errors is invalid sFlow receiver IP/hostname configuration. To diagnose, paste the receiver's IP address/hostname into the Ping Web page (Diagnostics → Ping/Ping6).

Flow Samples:

The total number of flow samples sent to the sFlow receiver.

Counter Samples:

The total number of counter samples sent to the sFlow receiver.

Port Statistics

Port:

The port number for which the following statistics applies.

Rx and Tx Flow Samples:

The number of flow samples sent to the sFlow receiver originating from this port. Here, flow samples are divided into Rx and Tx flow samples, where Rx flow samples contains the number of packets that were sampled upon reception (ingress) on the port and Tx flow samples contains the number of packets that were sampled upon transmission (egress) on the port.

Counter Samples:

The total number of counter samples sent to the sFlow receiver originating from this port.

■ Buttons



Auto-refresh:

Check this box to refresh the page automatically. Automatic refresh occurs every 3 seconds.

Refresh:

Click to refresh the page immediately.

Clear Receiver:

Clears the sFlow receiver counters.

Clear Ports:

Clears the per-port counters.

This Page Intentionally Left Blank

Chapter 17

Maintenance

Overview

This chapter describes the entire Maintenance configuration tasks including Save/Backup/Restore/Activate/Delete Restart Device, Factory Defaults, Firmware upgrade.

The menu and the submenu are shown below:

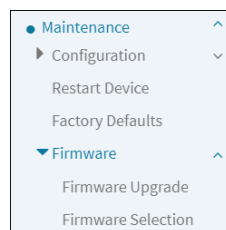
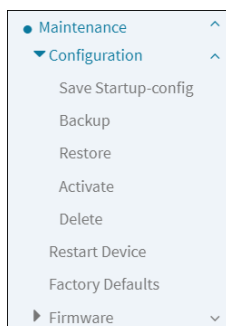
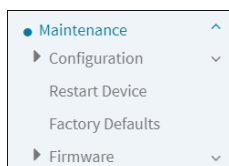

Configuration

The switch stores its configuration in a number of files in text format. The files are either virtual (RAM-based) or stored in flash on the switch.

There are three system files:

running-config: A virtual file that represents the currently active configuration on the switch. This file is volatile.

startup-config: The startup configuration for the switch, read at boot time.

default-config: A read-only file with vendor-specific configuration. This file is read when the system is restored to default settings.

Save Startup-Config

This copy running-config to startup-config, thereby ensuring that the current active configuration will be used at the next reboot.

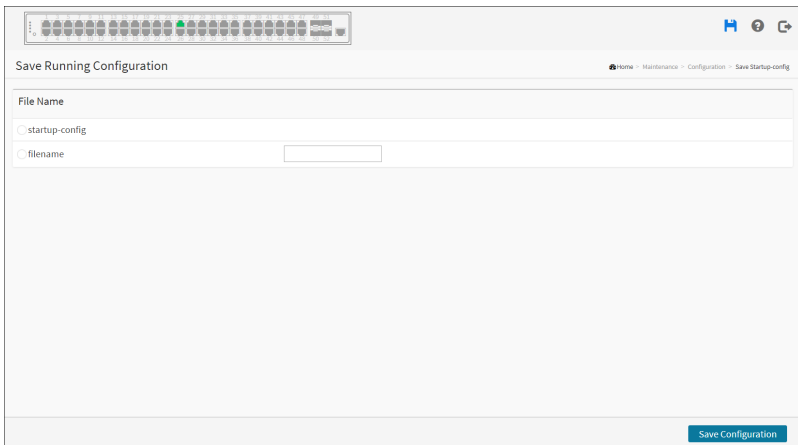

Web Interface

To save running configuration in the web interface:

1. Click Maintenance, Configuration and Save startup-config.
2. Click Save Configuration.

■ Button

Save Configuration:

Click to save configuration, the running configuration will be written to flash memory for system boot up to load this startup configuration file.

Backup

This section describes how to export the Switch Configuration for maintenance needs. Any current configuration files will be exported as text format.

The configuration files on the switch can be backed up and saved on the station running the web browser.

It is possible to transfer any of the files on the switch to the web browser. Select the running-config may take a little while to complete, as the file must be prepared before backup.

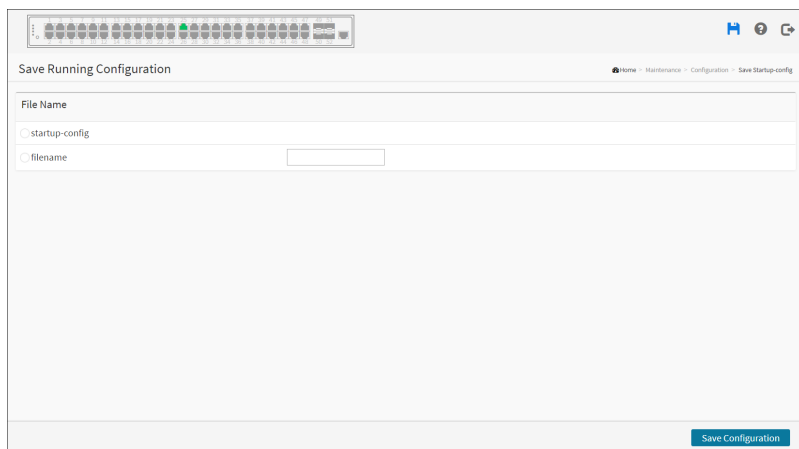

Web Interface

To backup configuration in the web interface:

1. Click Maintenance, Configuration and Backup.
2. Click Backup.

■ **Parameter description:**

running-config:

A virtual file that represents the currently active configuration on the switch. This file is volatile.

startup-config:

The startup configuration for the switch, read at boot time.

default-config:

A read-only file with vendor-specific configuration. This file is read when the system is restored to default settings.

■ Button

Download Configuration:

Click the button then the switch will start to transfer the configuration file to your workstation.

Restore

It is possible to import a file from the web browser to all the files on the switch, except default-config, which is read-only.

Select the source file to restore, and select the destination file on the target.

If the destination is running-config, the file will be applied to the switch configuration. This can be done in two ways:

Replace mode: The current configuration is fully replaced with the configuration specified in the source file.

Merge mode: The source file configuration is merged into running-config.

Restore Configuration Home - Maintenance - Configuration - Restore

File to Upload No file chosen

Destination File

File Name	Parameters
<input type="radio"/> running-config	<input checked="" type="radio"/> Replace <input type="radio"/> Merge
<input type="radio"/> files.zip	
<input type="radio"/> icon_list	
<input type="radio"/> Create new file	

Web Interface

To restore configuration in the web interface:

1. Click Maintenance, Configuration and Restore.
2. Click Restore.

3. Click Choose File and select the file.
4. Click Upload Configuration.

■ **Parameter description:**

running-config:

A virtual file that represents the currently active configuration on the switch. This file is volatile.

Replace mode: The current configuration is fully replaced with the configuration in the uploaded file.

Merge mode: The uploaded file is merged into running-config.

startup-config:

The startup configuration for the switch, read at boot time.

Create new file:

To create new files.

■ **Buttons**

Browse:

Click the button to search the configuration text file and filename

Upload Configuration:

Click the button to start transfer the source file to the destination file.

Activate

It is possible to activate any of the configuration files present on the switch, except for running-config which represents the currently active configuration.

Select the file to activate and click. This will initiate the process of completely replacing the existing configuration with that of the selected file.

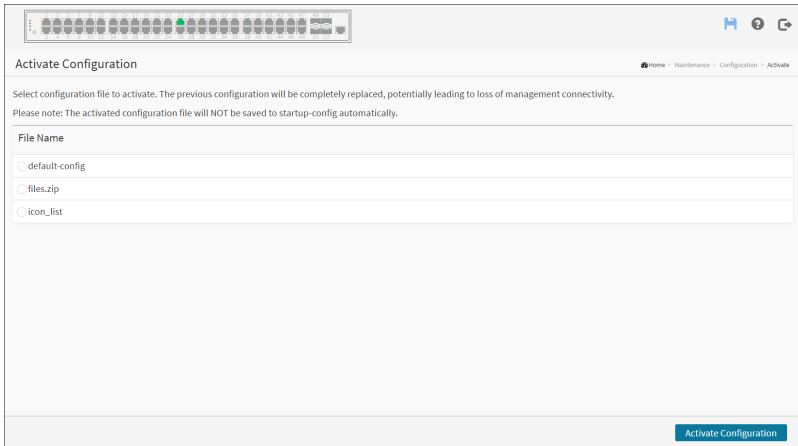

Web Interface

To activate configuration in the web interface:

1. Click Maintenance, Configuration and Activate.
2. Select the configuration you wish to activate.
3. Click Activate Configuration.

Delete

It is possible to delete any of the writable files stored in flash, including startup-config. If this is done and the switch is rebooted without a prior save operation, this effectively resets the switch to default configuration.

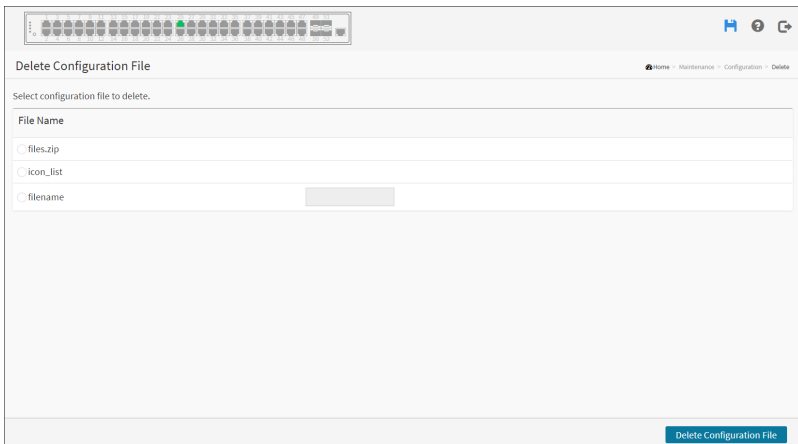

Web Interface

To delete configuration in the web interface:

1. Click Maintenance, Configuration and Delete.
2. Select the configuration you wish to delete.
3. Click Delete Configuration File.

Restart Device

This section describes how to restart the device for any maintenance needs. Any configuration files or scripts that you saved in the switch should still be available afterwards.

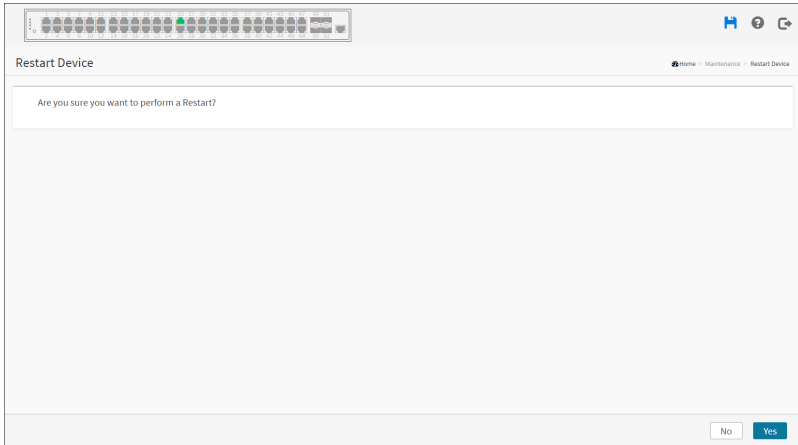

Web Interface

To Restart Device in the web interface:

1. Click Maintenance and Restart Device.
2. Click Yes.

Factory Defaults

This section describes how to restore the Switch configuration to Factory Defaults.

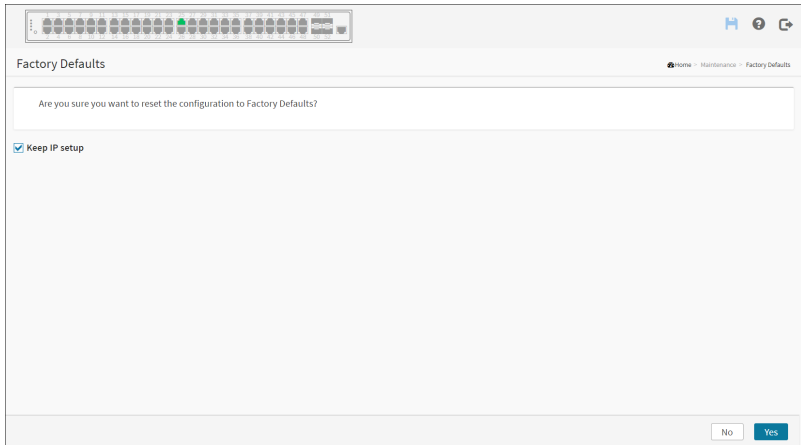

Web Interface

To restore a Factory Defaults in the web interface:

1. Click Maintenance and Factory Defaults.
2. You can choose if you want to keep ip configuration by checking the Keep IP setup option.
3. Click Yes.

Firmware

This section describes how to upgrade (or update) Firmware.

Firmware Upgrade

This page facilitates an update of the firmware controlling the switch..

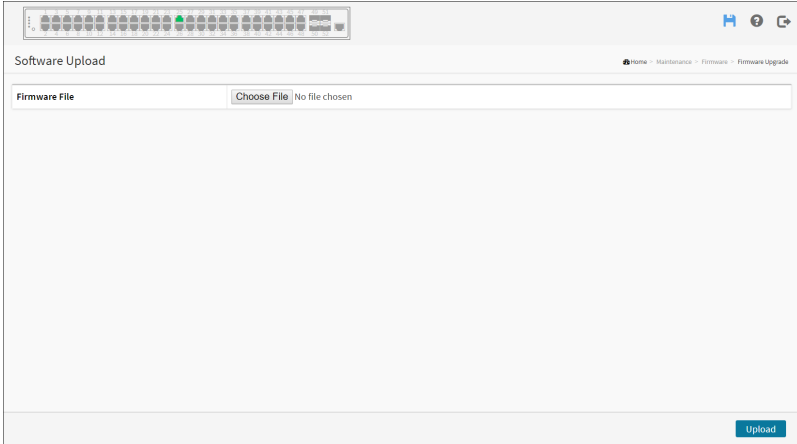

Web Interface

To update firmware of the device in the web interface:

1. Click Maintenance, Firmware and Firmware Upgrade.
2. Click Choose File to select a file.
3. Click Upload.

Firmware Selection

This page provides information about the active and alternate (backup) firmware images in the device, and allows you to activate the alternate image.

The web page displays two tables with information about the active and alternate firmware images.

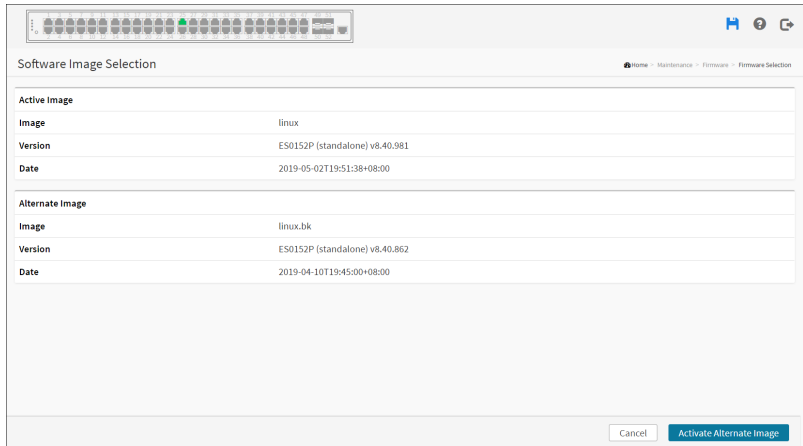

Web Interface

To show the Firmware information or swap booting firmware in the web interface:

1. Click Maintenance, Firmware and Firmware Selection.
2. Click Activate Alternate Image.

Image Information

Image:

The file name of the firmware image, from when the image was last updated.

Version:

The version of the firmware image.

Date:

The date where the firmware was produced.

This Page Intentionally Left Blank

Chapter 18

Device Management System (DMS)

Overview

1. DMS is an intelligent management tool embedded in switches to intuitively help IT/TS reduce support cost/time/effort.
2. All devices connected to the switches can be discovered and displayed by DMS automatically using standard networking protocols such as LLDP, UPnP, ONVIF, Bonjour, etc.
3. Users can operate the features below via an intuitive web GUI.
 - ◆ Power down, remotely, the IP cameras, NVRs, or any PoE devices.
 - ◆ Identify where exactly the broken cable is, remotely.
 - ◆ Detect abnormal traffic issues on IP cameras/NVR.
 - ◆ Monitor devices status intuitively, e.g. link up, PoE power, traffic, etc.
 - ◆ Configure VLAN/QoS intuitively for better solution quality/reliability.
4. DMS supports up to 256 devices within 4 subnets.

The embedded Device Managed System is designed to be extremely easy-to-use/manage/install IP Phone, IP Cam, or Wifi-AP for enterprise applications.

User can deploy IP Device through Topology/ Floor/ Map View to installation location, and through Diagnostics and Traffic Monitor, they may also check link status and monitor throughput as well.

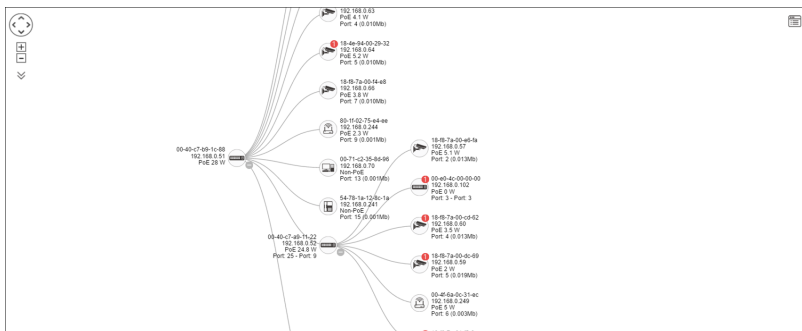

The main menu is shown below:



Management

The management menu is shown below:

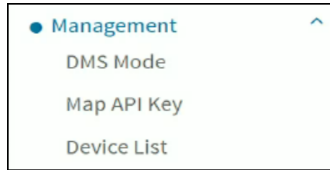

DMS Mode

Information Home - DMS Mode

Mode	Enabled ▾
Controller Priority	Low ▾
Total Device	9
On-line Devices	9
Off-line Devices	0
Controller IP	192.168.0.1

Apply

- ◆ DMS Mode: Enable/ Disable the DMS function. Or you can choose “High Priority”, then the device will be the master switch.
- ◆ Total Device: Here will show how many IP devices are detected and displayed in the topology view.
- ◆ On-Line Devices: Here will show how many IP devices on-line in the topology view.
- ◆ Off-Line Device: Here will show how many IP devices off-line in the topology view.
- ◆ Controller IP: It show the Master IP.

Map API Key

According to Google Maps Platform announcement, starting June 11, 2018, you will need a valid API key and a Google Cloud Platform billing account to access Google core products. Once you enable billing, you will gain access to your \$200 of free monthly usage to use for Google Maps, Routes, and Places products.

To use the map function in *Map View*, you will need to obtain the API key, enter it in this page's key field and click **Apply**.

Device List

It will show all devices and their information which are detected by DMS.

The screenshot shows the 'Devices List' page with the following data:

Remove	Status	Device Type	Model Name	Device Name	MAC	IP Address
	Online	SWITCH	ES0152P	ES0152P	00-40-C7-1C-E9-EB	192.168.0.1
	Online	PC	General PC	ATECH2-PC	50-E5-49-20-E0-5A	192.168.0.12
	Online	KVM	KE6900T/KE6940T	KE6900T/KE6940T	00-10-74-A9-00-00	192.168.0.62

- Auto-refresh If you want to auto-refresh the information then you need to evoke the “Auto refresh”.
- Click this icon to Refresh the status of all devices.
- Click this icon to Edit Device Name and http Port.

User can press “Edit” icon to edit device name and HTTP port for each IP device. This function can also be configured in the Dashboard of Topology view.

There is no HTTP connection function for Unknown Device and PC type devices, so UI doesn’t provide “Edit HTTP port” function for configuring it.

The close-up shows the following data for the KVM device:

Online	KVM	KE6900T/KE6940T	KE6900T/KE6940T	<input type="text" value="KE6900T/KE6940T"/>	00-10-74-A9-00-00	192.168.0.62
Online	KVM	KE6900T/KE6940T	KE6900T/KE6940T	<input type="text" value="KE6900T/KE6940T"/>	00-10-74-A9-01-12	192.168.0.66

- d) Search: Search devices by key words with full text search.
- e) Remove Only Offline devices provide “Remove” function to remove from DMS device list.

Note: The device name will not save until you click the Apply button.
Please do not click refresh, auto-refresh or edit button before you apply new device name.

Graphical Monitoring

The graphical monitoring menu is shown below:



Topology View

DMS can automatically discover all IP devices and display the devices by graphic networking topology view. User could manage and monitor them by the Topology View, such as to remotely diagnose the cable connection status, auto alarm notifications on critical events, remotely reboot PoE device when it's not alive. Therefore, the user can apply DMS platform to solve the abnormal issues anytime and anywhere by tablet or smart phone, and keep the network works smoothly.

Click Graphical Monitoring Topology View, you can see a visual view of the network topology.

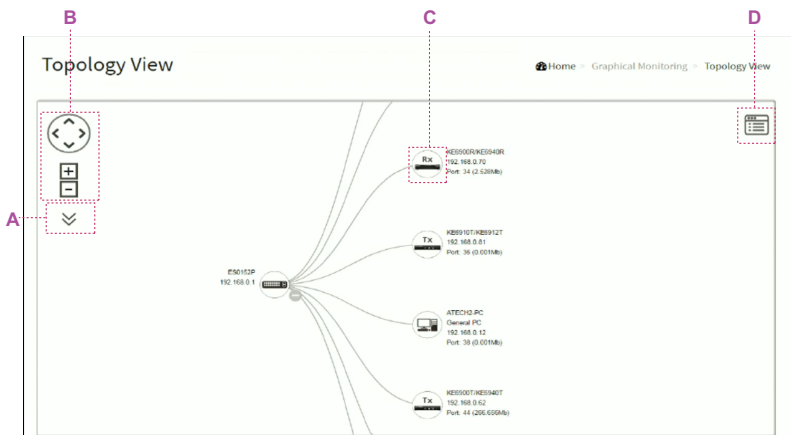





Parameter description:

- a)  Icon with information list: User can select what kind of information should be shown on the topology view of each device. Up to 3 items can be selected.



- b)  Icon with plus and minus marks: Zoom in and zoom out the topology view. User can scroll up/down with mouse to achieve the same purpose.



c) Device picture

- ◆  Icon with black mark: Device link up. User can select function and check issues.
- ◆  Icon with red mark: Device link down. User can diagnose the link status.
- ◆  Icon with numbers: It means some events happened (e.g. Device Off-line, IP Duplicate...etc.) on the IP device, user can click on the device icon to check events in Notification.
- ◆  Icon with question: It means the IP device is detected by DMS, but the device type can't be recognized which will be classified as an unknown device type.
- ◆ To left-click any device icon to display the device consoles for further actions:

ES0152P	
Device Type	SWITCH
Device Name	ES0152P
Model Name	ES0152P
Mac Address	00-40-c7-1c-e9-eb
DHCP Client	Disable
IPv4 Address	192.168.0.1
Subnet Mask	255.255.255.0
Gateway	192.168.0.254
Http Port	80
PoE Supply	3.9 W
<div style="display: flex; justify-content: space-around;"> <div style="text-align: center;">  Login </div> <div style="text-align: center;">  Upgrade </div> <div style="text-align: center;">  Find Switch </div> <div style="text-align: center;">  PoE Config </div> </div>	
<div style="display: flex; justify-content: space-around;"> <div style="text-align: center;">  Dashboard </div> <div style="text-align: center;">  Notification </div> </div>	

1. Dashboard Console: It displays device info and related actions for the device.

- ◆ Different device type supports different function:
 - ◆ If an IP device is recognized as DMS switch, it will support “Upgrade“, “PoE Config” and “Find Switch” function.
 - ◆ If an IP device is recognized as PoE device, it will support “PoE Reboot” function in addition to “Upgrade” and “Find Switch”.
 - ◆ If an IP device is recognized as IP cam via ONVIF protocol.
- ◆ Device Type: It can be displayed automatically. If an unknown type is detected, user can still select type from a pre-defined list.
- ◆ Device Name: Create your own Device Name or alias for easy management such as, 1F_Lobby_Cam1.
- ◆ Model Name, MAC Address, IPv4 Address, Subnet Mask, Gateway, PoE Supply and PoE Used are displayed automatically by DMS.
- ◆ Http Port: Re-assign http port number to the device for better security.
- ◆ DHCP Client: Enable or Disable the DHCP client. If this feature is enabled, the system will configure the IPv4 address and mask of the interface using the DHCP protocol. The DHCP client will announce the configured System Name as hostname to provide DNS lookup.
- ◆  Login: Click the Login Action Icon to log in the device via http for further configuration or status monitoring.

- ◆  Upgrade: Click it to upgrade software version.
- ◆  Find Switch: When this feature is activated, the switch LED will all lighten up and flicker for 15 seconds.
- ◆  PoE Config: Click it to configure the PoE function, enable/disable PoE Auto Checking and enable/disable PoE mode for per port.

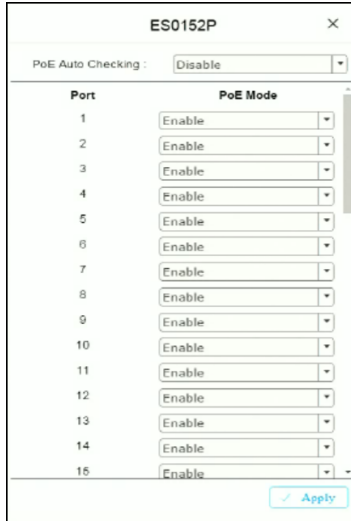



- ◆  Diagnostics: Click Diagnostic Action Icon to perform the cable diagnostics, to exam where the broken cable is, and, check if the device connection is alive or not by ping.

Cable Status:

- ◆ Green icon: Cable is connected correctly.
- ◆ Red icon: Cable is not connected correctly. User can check the distance info (XX meters) to identify the broken cable location.

Connection:

- ◆ Green icon: Device is pinged correctly.
- ◆ Red icon: Device is not transmitted/receiving data correctly. Which means it might not be pinged successfully.

- ◆  **PoE Reboot:** Click Reboot Action Icon to reboot the device remotely so as recover the device back to its normal operation.
 - ◆  **Icon with blank node:** When DMS switch detects more than two IP devices from the same port, switch can't resolve this IP device's layout, instead, it will show a blank node to present this situation. User can use “Parent Node” function to adjust layout in Dashboard.
2. Notification Console: It displays alarms and logs triggered by events.

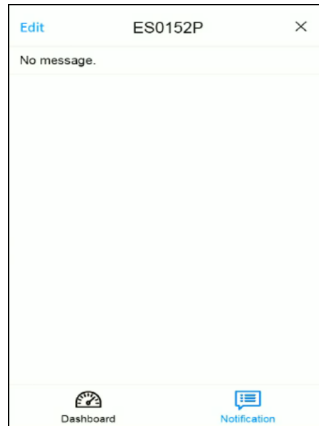

3. Monitor Console: It displays the traffics for device health check purpose.
- ◆ For each IP device except DMS switches, User can set a threshold of throughput for IP devices, and get notification when throughput is lower or higher than settings.
 - ◆ If both values are “0”, it means the function is disabled.
 - ◆ Polling interval is 1 second, when the page is closed, the Polling interval will change to around 5 seconds.

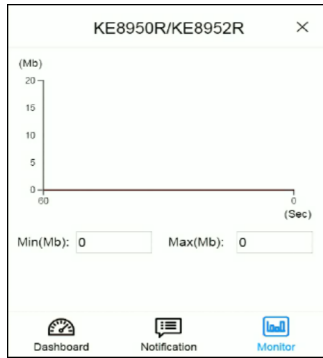

d)  In the upper right corner, there is a “Setting icon”. When user clicks the icon, it will pop-up Device, Group, Config, export topology view and advanced search functions for the topology.

◆ Device Search Console

All devices and information will show on the list.

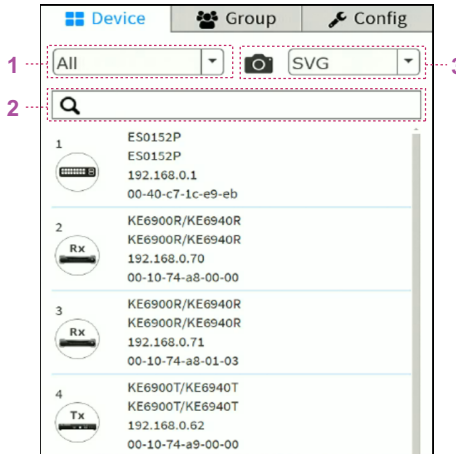

No.	Function
1	Filter devices by Device Type
2	Search devices by key words full text search
3	Save the whole View to SVG, PNG or PDF

- ◆ Group Setting Console
 - ◆ User can set VLAN group for each IP device by OUI or clicking device icon, and configure traffic priority (0~7) for each VLAN group.
 - ◆ Using Mac Based VLAN to isolate groups.
 - ◆ One IP device only can join one VLAN group.

No.	Function
1	Group devices by filtering, searching, clicking device icons, or specifying OUI
2	Configure traffic priority for the VLAN
3	Assign VLAN ID or Name to Group.

- ◆ System Setting Console

No.	Function
1	Here will show how many IP devices are detected and displayed in the topology view.
2	The Master IP
3	You can enable/disable DHCP server
4	<p>- Single Subnet: DMS will base on the master switch's IP address. Here the subnet means "255.255.255.0".</p> <p>- Multiple Subnet: To provide 4 ranges for inputting manually.(In the case, we will suggest user to adjust switch's subnet mask to "255.255.0.0" also to avoid IP devices can't be recognized.)</p>

Floor View

User can easily plan IP devices installation location onto the custom uploaded floor images.

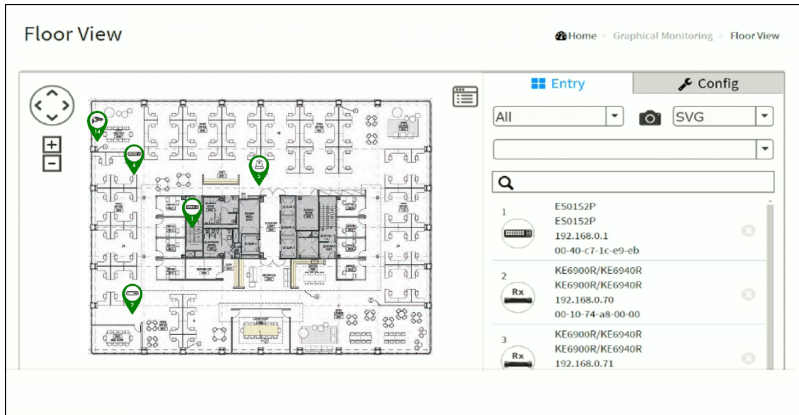

- ◆ Anchor Devices onto Floor Maps
- ◆ Find Device Location Instantly
- ◆ 10 Maps can be Stored in Each Switch
- ◆ IP Surveillance/VoIP/WiFi Applications
- ◆ Other Feature same as Topology View
- ◆ To place and remove a device icon:

- ◆ To select a device and click its icon from the device list.
- ◆ The device icon will show on the floor image's default location.
- ◆ To click and hold left mouse by dragging-and-dropping the icon to the correct location on the floor view.
- ◆ To click cross sign on the right side of device icon to remove a device from all floor view images.
- ◆ If there are more than two floor images, it can be selected from the field above the search field.

Map View

It can help to find the location of the devices even they are installed in different buildings. User can place the device icon on the Map View of which navigated by Google map.

You can:

- ◆ Anchor Devices onto Google Map.
- ◆ Find Devices Instantly from Map.
- ◆ Online Search Company/Address.
- ◆ Outdoor IP Cam/WiFi Applications.
- ◆ Other Feature same as Topology View.

Maintenance

Floor Image

In this page, user can add or delete a floor image.

Floor Image Management Home > Maintenance > Floor Image

Maximum: 10 files Used: 0 file(s) Free: 10 file(s)

Add Floor Image: No File Selected

Name

Select	No.	File Name	Image
No information found			

- ◆ Each DMS switch provides 10 files space for uploading.
- ◆ Only support JPG and PNG formats.
- ◆ File size is limited to 512KB.
- ◆ All DMS switches' floor image in the same network can be shared together.
 - ◆ For example:
If Switch1 has uploaded 10 floor images, Switch2 uploaded 5 images, the total 15 floor images can be shared and selected on all DMS switches in the same network.
- ◆ File name will attach IP address to let user know the floor image is stored on which DMS switch.

Diagnostics

In this page, all IP devices will be listed in a table, user can diagnose connection status of IP device in the network.

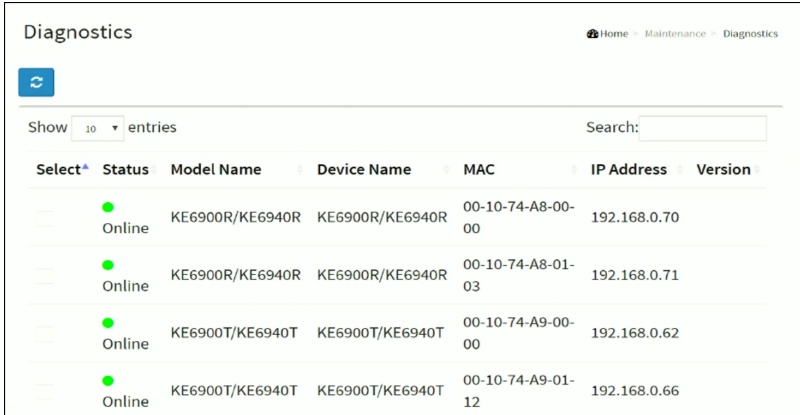

Diagnostics Home - Maintenance - Diagnostics

Show entries Search:

Select	Status	Model Name	Device Name	MAC	IP Address	Version
<input type="checkbox"/>	Online	KE6900R/KE6940R	KE6900R/KE6940R	00-10-74-A8-00-00	192.168.0.70	
<input type="checkbox"/>	Online	KE6900R/KE6940R	KE6900R/KE6940R	00-10-74-A8-01-03	192.168.0.71	
<input type="checkbox"/>	Online	KE6900T/KE6940T	KE6900T/KE6940T	00-10-74-A9-00-00	192.168.0.62	
<input type="checkbox"/>	Online	KE6900T/KE6940T	KE6900T/KE6940T	00-10-74-A9-01-12	192.168.0.66	

- ◆ User selects a device to start the diagnostics procedure automatically.



Diagnostics Home - Maintenance - Diagnostics

[Another Try](#)

Show entries Search:

Select	Status	Model Name	Device Name	MAC	IP Address	Version
<input checked="" type="checkbox"/>	Online	KE6900R/KE6940R	KE6900R/KE6940R	00-10-74-A8-00-00	192.168.0.70	

Showing 1 to 8 of 8 entries Previous Next

 192.168.0.1 00-40-c7-1c-e9-eb

 Connection.....
 Cable status.....

 192.168.0.70 00-10-74-a8-00-00

- ◆ [Another Try](#) Press “Another Try” to go back IP device list page.
- ◆ The diagnostic function can also be found in Dashboard of topology view.

IP Routes Configuration

It is recommended to set the connected device's IP address to 192.168.0.x when connecting to the ES0152/ES0152P. If the IP address is not set to 192.168.0.x (e.g. VE89 Series with default IP address 169.254.0.x), it is required to configure the IP Routes on the ES0152/ES0152P for the connected devices to be discovered by the ES0152/ES0152P.



To configure the controller ES0152/ES0152P, do the following:

1. Go to “Switch” → “IP Address” and select “Advanced Settings”. Add a Network **0.0.0.0** and set the Gateway to **169.254.0.254**. Add another Network **169.254.0.0** and set the Gateway to **169.254.0.254**, then click **Apply**.

The screenshot shows the ATEN ES0152P web interface. The left sidebar has a menu with 'Switch' selected. Under 'Switch', 'IP Address' is selected, and 'Advanced Settings' is highlighted with a red box. The main content area shows the 'IP Routes' configuration page. The 'IP Routes' table is as follows:

Delete	Network	Mask Length	Gateway	Distance/Next Hop VLAN
<input type="checkbox"/>	0.0.0.0	0	169.254.0.254	1
<input type="checkbox"/>	169.254.0.0	16	169.254.0.254	0

The 'Gateway' column in the table is highlighted with a red box. Below the table is an 'Add Route' button. At the bottom right of the interface are 'Reset' and 'Apply' buttons.

- Go to “DMS” → “Graphical Monitoring” and select “Topology View”.
Click  to bring out a system panel, and select . Change the “IP Range” to **Multiple Subnet**, and add a new range from **169.254.0.1** and **169.254.0.254**.

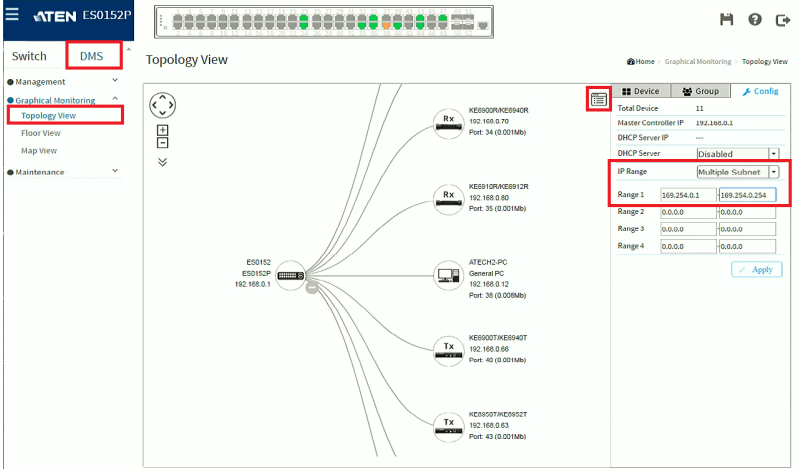

The screenshot displays the ATEN ES0152P DMS interface. The left sidebar shows the navigation menu with "DMS" selected under "Switch" and "Graphical Monitoring" selected under "Management". The main area shows the "Topology View" of the network. The central diagram shows the ES0152P switch (192.168.0.1) connected to five devices: KES900P/KES940R (192.168.0.70), KES910R/KES912R (192.168.0.80), ATECH2.PC General PC (192.168.0.12), KES600T/KES640T (192.168.0.66), and KES600T/KES652T (192.168.0.63). The right sidebar shows the configuration panel for the selected device. The "IP Range" is set to "Multiple Subnet". A new range, Range 1, is defined with the IP range 169.254.0.1 to 169.254.0.254. The "Apply" button is visible at the bottom of the configuration panel.

Switch: **DMS**

Management

- Graphical Monitoring
- Topology View
- Floor View
- Map View

Maintenance

Topology View

Home - Graphical Monitoring - Topology View

Device Group Config

Total Device: 11

Master Controller IP: 192.168.0.1

DHCP Server IP: ---

DHCP Server: Disabled

IP Range: Multiple Subnet

Range 1	169.254.0.1	169.254.0.254
Range 2	0.0.0.0	0.0.0.0
Range 3	0.0.0.0	0.0.0.0
Range 4	0.0.0.0	0.0.0.0

Apply

This Page Intentionally Left Blank

Safety Instructions

General

- ◆ This product is for indoor use only.
- ◆ Read all of these instructions. Save them for future reference.
- ◆ Follow all warnings and instructions marked on the device.
- ◆ Do not place the device on any unstable surface (cart, stand, table, etc.). If the device falls, serious damage will result.
- ◆ Do not use the device near water.
- ◆ Do not place the device near, or over, radiators or heat registers.
- ◆ The device cabinet is provided with slots and openings to allow for adequate ventilation. To ensure reliable operation, and to protect against overheating, these openings must never be blocked or covered.
- ◆ The device should never be placed on a soft surface (bed, sofa, rug, etc.) as this will block its ventilation openings. Likewise, the device should not be placed in a built in enclosure unless adequate ventilation has been provided.
- ◆ Never spill liquid of any kind on the device.
- ◆ Avoid circuit overloads. Before connecting equipment to a circuit, know the power supply's limit and never exceed it. Always review the electrical specifications of a circuit to ensure that you are not creating a dangerous condition or that one doesn't already exist. Circuit overloads can cause a fire and destroy equipment.
- ◆ Unplug the device from the wall outlet before cleaning. Do not use liquid or aerosol cleaners. Use a damp cloth for cleaning.
- ◆ The device should be operated from the type of power source indicated on the marking label. If you are not sure of the type of power available, consult your dealer or local power company.
- ◆ To prevent damage to your installation it is important that all devices are properly grounded.
- ◆ The device is designed for IT power distribution systems with 230V phase-to-phase voltage.
- ◆ The device is equipped with a 3-wire grounding type plug. This is a safety feature. If you are unable to insert the plug into the outlet, contact your

electrician to replace your obsolete outlet. Do not attempt to defeat the purpose of the grounding-type plug. Always follow your local/national wiring codes.

- ◆ Do not allow anything to rest on the power cord or cables. Route the power cord and cables so that they cannot be stepped on or tripped over.
- ◆ If an extension cord is used with this device make sure that the total of the ampere ratings of all products used on this cord does not exceed the extension cord ampere rating. Make sure that the total of all products plugged into the wall outlet does not exceed 15 amperes.
- ◆ To help protect your system from sudden, transient increases and decreases in electrical power, use a surge suppressor, line conditioner, or un-interruptible power supply (UPS).
- ◆ Position system cables and power cables carefully; Be sure that nothing rests on any cables.
- ◆ When connecting or disconnecting power to hot-pluggable power supplies, observe the following guidelines:
 - ◆ Install the power supply before connecting the power cable to the power supply.
 - ◆ Unplug the power cable before removing the power supply.
 - ◆ If the system has multiple sources of power, disconnect power from the system by unplugging all power cables from the power supplies.
- ◆ Never push objects of any kind into or through cabinet slots. They may touch dangerous voltage points or short out parts resulting in a risk of fire or electrical shock.
- ◆ Do not attempt to service the device yourself. Refer all servicing to qualified service personnel.
- ◆ If the following conditions occur, unplug the device from the wall outlet and bring it to qualified service personnel for repair.
 - ◆ The power cord or plug has become damaged or frayed.
 - ◆ Liquid has been spilled into the device.
 - ◆ The device has been exposed to rain or water.
 - ◆ The device has been dropped, or the cabinet has been damaged.
 - ◆ The device exhibits a distinct change in performance, indicating a need for service.
 - ◆ The device does not operate normally when the operating instructions are followed.

- ◆ Only adjust those controls that are covered in the operating instructions. Improper adjustment of other controls may result in damage that will require extensive work by a qualified technician to repair.
- ◆ Additional protection to secure and fix the equipment is needed if the equipment is installed by stacking; by locking it to the rack, screwing it to the frame, or other similar methods.
- ◆ Keep the Cat 5e/6 cable as far away as possible from potential sources of EMI, such as electrical cables, transformers, and light fixtures. Do not tie the cables to electrical conduits or lay the cables on electrical fixtures.
- ◆ The SFP module to be installed must comply with
 - ◆ CLASS 1 LASER PRODUCT according to IEC/EN 60825-1”
 - ◆ 21 CFR 1040.10 and 1040.11 except for deviations pursuant to Laser Notice No. 50, dated June 24, 2007

Rack Mounting

- ◆ Before working on the rack, make sure that the stabilizers are secured to the rack, extended to the floor, and that the full weight of the rack rests on the floor. Install front and side stabilizers on a single rack or front stabilizers for joined multiple racks before working on the rack.
- ◆ Always load the rack from the bottom up, and load the heaviest item in the rack first.
- ◆ Make sure that the rack is level and stable before extending a device from the rack.
- ◆ Use caution when pressing the device rail release latches and sliding a device into or out of a rack; the slide rails can pinch your fingers.
- ◆ After a device is inserted into the rack, carefully extend the rail into a locking position, and then slide the device into the rack.
- ◆ Do not overload the AC supply branch circuit that provides power to the rack. The total rack load should not exceed 80 percent of the branch circuit rating.
- ◆ Make sure that all equipment used on the rack – including power strips and other electrical connectors – is properly grounded.
- ◆ Ensure that proper airflow is provided to devices in the rack.
- ◆ Ensure that the operating ambient temperature of the rack environment does not exceed the maximum ambient temperature specified for the equipment by the manufacturer

- ◆ Do not step on or stand on any device when servicing other devices in a rack.

Consignes de sécurité

Général

- ◆ Ce produit est destiné exclusivement à une utilisation à l'intérieur.
- ◆ Veuillez lire la totalité de ces instructions. Conservez-les afin de pouvoir vous y référer ultérieurement.
- ◆ Respectez l'ensemble des avertissements et instructions inscrits sur l'appareil.
- ◆ Ne placez jamais l'unité sur une surface instable (chariot, pied, table, etc.). Si l'unité venait à tomber, elle serait gravement endommagée.
- ◆ N'utilisez pas l'unité à proximité de l'eau.
- ◆ Ne placez pas l'unité à proximité de ou sur des radiateurs ou bouches de chaleur.
- ◆ Le boîtier de l'unité est doté de fentes et d'ouvertures destinées à assurer une ventilation adéquate. Pour garantir un fonctionnement fiable et protéger l'unité contre les surchauffes, ces ouvertures ne doivent jamais être bloquées ou couvertes.
- ◆ L'unité ne doit jamais être placée sur une surface molle (lit, canapé, tapis, etc.) car ses ouvertures de ventilation se trouveraient bloquées. De même, l'unité ne doit pas être placée dans un meuble fermé à moins qu'une ventilation adaptée ne soit assurée.
- ◆ Ne renversez jamais de liquides de quelque sorte que ce soit sur l'unité.
- ◆ Evitez toute surcharge du circuit. Avant de connecter l'équipement à un circuit, vérifiez la limite de l'alimentation et ne la dépassez pas. Contrôlez toujours les caractéristiques électriques d'un circuit pour vous assurer de ne pas créer de situation dangereuse ou qu'il n'y en a pas déjà. Les surcharges du circuit peuvent provoquer un incendie et détruire l'équipement.
- ◆ Débranchez l'unité de la prise murale avant de la nettoyer. N'utilisez pas de produits de nettoyage liquide ou sous forme d'aérosol. Utilisez un chiffon humide pour le nettoyage de l'unité.
- ◆ L'appareil doit être alimenté par le type de source indiqué sur l'étiquette. Si vous n'êtes pas sûr du type d'alimentation disponible, consultez votre revendeur ou le fournisseur local d'électricité.
- ◆ Afin de ne pas endommager votre installation, vérifiez que tous les périphériques sont correctement mis à la terre.

- ♦ L'unité est équipée d'une fiche de terre à trois fils. Il s'agit d'une fonction de sécurité. Si vous ne parvenez pas à insérer la fiche dans la prise murale, contactez votre électricité afin qu'il remplace cette dernière qui doit être obsolète. N'essayez pas d'aller à l'encontre de l'objectif de la fiche de terre. Respectez toujours les codes de câblage en vigueur dans votre région/pays.
- ♦ L'équipement doit être installé à proximité de la prise murale et le dispositif de déconnexion (prise de courant femelle) doit être facile d'accès.
- ♦ La prise murale doit être installée à proximité de l'équipement et doit être facile d'accès.
- ♦ Veillez à ce que rien ne repose sur le cordon d'alimentation ou les câbles. Acheminez le cordon d'alimentation et les câbles de sorte que personne ne puisse marcher ou trébucher dessus.
- ♦ En cas d'utilisation d'une rallonge avec cette unité, assurez-vous que le total des ampérages de tous les produits utilisés sur cette rallonge ne dépasse pas l'ampérage nominal de cette dernière. Assurez-vous que le total des ampérages de tous les produits branchés sur la prise murale ne dépasse pas 15 ampères.
- ♦ Pour contribuer à protéger votre système contre les augmentations et diminutions soudaines et transitoires de puissance électrique, utilisez un parasurtenseur, un filtre de ligne ou un système d'alimentation sans coupure (UPS).
- ♦ Placez les câbles du système et les câbles d'alimentation avec précaution ; veillez à ce que rien ne repose sur aucun des câbles.
- ♦ Lors du branchement ou du débranchement à des blocs d'alimentation permettant la connexion à chaud, veuillez respecter les lignes directrices suivantes:
- ♦ Installez le bloc d'alimentation avant de brancher le câble d'alimentation à celui-ci.
- ♦ Débranchez le câble d'alimentation avant de retirer le bloc d'alimentation.
- ♦ Si le système présente plusieurs sources d'alimentation, déconnectez le système de l'alimentation en débranchant tous les câbles d'alimentation des blocs d'alimentation.
- ♦ N'insérez jamais d'objets de quelque sorte que ce soit dans ou à travers les fentes du boîtier. Ils pourraient entrer en contact avec des points de tension dangereuse ou court-circuiter des pièces, entraînant ainsi un risque d'incendie ou de choc électrique.

- ◆ N'essayez pas de réparer l'unité vous-même. Confiez toute opération de réparation à du personnel qualifié.
- ◆ Si les conditions suivantes se produisent, débranchez l'unité de la prise murale et amenez-la à un technicien qualifié pour la faire réparer:
 - ◆ Le cordon d'alimentation ou la fiche ont été endommagés ou éraillés.
 - ◆ Du liquide a été renversé dans l'unité.
 - ◆ L'unité a été exposée à la pluie ou à l'eau.
 - ◆ L'unité est tombée ou le boîtier a été endommagé.
 - ◆ Les performances de l'unité sont visiblement altérées, ce qui indique la nécessité d'une réparation.
 - ◆ L'unité ne fonctionne pas normalement bien que les instructions d'utilisation soient respectées.
- ◆ N'utilisez que les commandes qui sont abordées dans le mode d'emploi. Le réglage incorrect d'autres commandes peut être à l'origine de dommages qui nécessiteront beaucoup de travail pour qu'un technicien qualifié puisse réparer l'unité.
- ◆ Tenez le câble de catégorie 5e/6 le plus éloigné possible des sources potentielles d'interférences électromagnétiques, telles que les câbles électriques, transformateurs et appareils d'éclairage. Ne nouez pas les câbles à des conduits électriques et ne les faites pas passer sur des installations électriques.

Montage sur bâti

- ◆ Avant de travailler sur le bâti, assurez-vous que les stabilisateurs sont bien fixés sur le bâti, qu'ils sont étendus au sol et que tout le poids du bâti repose sur le sol. Installez les stabilisateurs avant et latéraux sur un même bâti ou bien les stabilisateurs avant si plusieurs bâtis sont réunis, avant de travailler sur le bâti.
- ◆ Chargez toujours le bâti de bas en haut et chargez l'élément le plus lourd en premier.
- ◆ Assurez-vous que le bâti est à niveau et qu'il est stable avant de sortir une unité du bâti.
- ◆ Agissez avec précaution lorsque vous appuyez sur les loquets de libération du rail d'unité et lorsque vous faites coulisser une unité dans et hors d'un bâti ; vous pourriez vous pincer les doigts dans les rails.
- ◆ Une fois qu'une unité a été insérée dans le bâti, étendez avec précaution le rail dans une position de verrouillage puis faites glisser l'unité dans le bâti.
- ◆ Ne surchargez pas le circuit de l'alimentation CA qui alimente le bâti. La charge totale du bâti ne doit pas dépasser 80 % de la capacité du circuit.
- ◆ Assurez-vous que tous les équipements utilisés sur le bâti, y-compris les multiprises et autres connecteurs électriques, sont correctement mis à la terre.
- ◆ Assurez-vous que les unités présentes dans le bâti bénéficie d'une circulation d'air suffisante.
- ◆ Assurez-vous que la température ambiante de fonctionnement de l'environnement du bâti ne dépasse pas la température ambiante maximale spécifiée pour l'équipement par le fabricant.
- ◆ Ne marchez sur aucun appareil lors de la maintenance d'autres appareils d'un bâti.

Technical Support

International

- ◆ For online technical support – including troubleshooting, documentation, and software updates: <http://eservice.aten.com>
- ◆ For telephone support, see *Telephone Support*, page iii.

North America

Email Support		support@aten-usa.com
Online Technical Support	Troubleshooting Documentation Software Updates	http://eservice.aten.com
Telephone Support		1-888-999-ATEN ext 4988 1-949-428-1111

When you contact us, please have the following information ready beforehand:

- ◆ Product model number, serial number, and date of purchase.
- ◆ Your computer configuration, including operating system, revision level, expansion cards, and software.
- ◆ Any error messages displayed at the time the error occurred.
- ◆ The sequence of operations that led up to the error.
- ◆ Any other information you feel may be of help.

Troubleshoot

Faults	Possible Causes	Suggested Solutions
System LED is Off	The switch is not receiving power.	<ol style="list-style-type: none"> 1. Check if correct power cord is connected firmly to the switch and to the AC outlet socket. 2. Perform power cycling the switch by unplugging and plugging the power cord back into the switch. 3. If the LED is still off, try to plug power cord into different AC outlet socket to make sure correct AC source is supplied.
System LED is Red	An abnormal state has been detected by the switch.	Check the system log within the switch from WEB UI to understand the abnormal state (e.g. exceeding operating temperature range) and take corresponding actions to resolve.
Port Status LED is Off in Link/Act/Speed Mode	The port is not connected or the connection is not working.	<ol style="list-style-type: none"> 1. Check if the cable connector plug is firmly inserted and locked into the port at both the switch and the connected device. 2. Make sure the connected device is up and running correctly. 3. If the symptom still exists, try different cable or different port, in order to identify if it is related to the cable or specific port. 4. Check if the port is disabled in the configuration settings via WEB user interface.
Port Status LED is Off in PoE Mode	The port is not supplying power.	<ol style="list-style-type: none"> 1. Check if the cable connector plug is firmly inserted and locked into the port at both the switch and the connected device. 2. Make sure the correct Ethernet cables are used. 3. If the symptom still exists, try different cable or different port, in order to identify if it is related to the cable or specific port. 4. Check if the port is disabled in the configuration settings via WEB user interface.

Specifications

Function	ES0152	ES0152P
Connectors		
RJ-45 10/100/1000 Ports	48	
SFP+ Uplink Ports	4	
Console Ports	1 x RJ-45	
Performance		
Switching Capacity	176 Gbps	
Forwarding Rate	130.95 Mpps	
Jumbo Frames	10240 Bytes	
Maximum Input Power Rating	100 – 240 V AC, 50 – 60 Hz, 1 A	100 – 240 V AC, 50 – 60 Hz, 10 A
Power Consumption	AC 100 V / 45.98 W AC 220 V / 46.55 W	AC 100 V / 885.36 W AC 220 V / 858.09 W (PoE on)
Environmental		
Operating Temperature	0 – 50 °C	
Storage Temperature	–20 – 60 °C	
Humidity	10 – 90% RH, Non-condensing	
Physical Properties		
Rack Space	19"	
Housing	Metal	
Weight	4.20 kg	5.60 kg
Dimensions (L x W x H)	44.20 x 30.00 x 4.40 cm	44.20 x 37.50 x 4.40 cm
PoE		
Standard Compliance	N/A	802.3af PoE / 802.3at PoE+
Number of Ports That Support PoE/PoE +	N/A	48
Max. PoE Power Budget per Port	N/A	PoE: 15.4 W / PoE+: 30.0 W
Total PoE Power Budget	N/A	740 W

Limited Warranty

ATEN warrants its hardware in the country of purchase against flaws in materials and workmanship for a Warranty Period of two [2] years (warranty period may vary in certain regions/countries) commencing on the date of original purchase. This warranty period includes the [LCD panel of ATEN LCD KVM switches](#). Select products are warranted for an additional year (see [A+ Warranty](#) for further details). Cables and accessories are not covered by the Standard Warranty.

What is covered by the Limited Hardware Warranty

ATEN will provide a repair service, without charge, during the Warranty Period. If a product is defective, ATEN will, at its discretion, have the option to (1) repair said product with new or repaired components, or (2) replace the entire product with an identical product or with a similar product which fulfills the same function as the defective product. Replaced products assume the warranty of the original product for the remaining period or a period of 90 days, whichever is longer. When the products or components are replaced, the replacing articles shall become customer property and the replaced articles shall become the property of ATEN.

To learn more about our warranty policies, please visit our website:

<http://www.aten.com/global/en/legal/policies/warranty-policy/>

© Copyright 2022 ATEN® International Co., Ltd.
Released: 2022-03-25

ATEN and the ATEN logo are registered trademarks of ATEN International Co., Ltd. All rights reserved. All other brand names and trademarks are the registered property of their respective owners.