



Simply Better Connections

VP3520

5 x 2 True 4K Seamless Presentation
Matrix Switch with Control
User Manual

Compliance Statements

FEDERAL COMMUNICATIONS COMMISSION INTERFERENCE STATEMENT

This equipment has been tested and found to comply with the limits for a Class A digital device, pursuant to Part 15 of the FCC Rules. These limits are designed to provide reasonable protection against harmful interference when the equipment is operated in a commercial environment. This equipment generates, uses, and can radiate radio frequency energy and, if not installed and used in accordance with the instruction manual, may cause harmful interference to radio communications. Operation of this equipment in a residential area is likely to cause harmful interference in which case the user will be required to correct the interference at his own expense.

The device complies with Part 15 of the FCC Rules. Operation is subject to the following two conditions: (1) this device may not cause harmful interference, and (2) this device must accept any interference received, including interference that may cause undesired operation.

FCC Caution

Any changes or modifications not expressly approved by the party responsible for compliance could void the user's authority to operate this equipment.

Warning

Operation of this equipment in a residential environment could cause radio interference.

Achtung

Der Gebrauch dieses Geräts in Wohnumgebung kann Funkstörungen verursachen.

Suggestion

Shielded twisted pair (STP) cables must be used with the unit to ensure compliance with FCC & CE standards.



KCC Statement

유선 제품용 / A 급 기기 (업무용 방송 통신 기기)
이 기기는 업무용 (A 급) 전자파적합기기로서 판매자 또는 사용자는 이
점을 주의하시기 바라며, 가정 외의 지역에서 사용하는 것을 목적으로
합니다.

Industry Canada Statement

This Class A digital apparatus complies with Canadian ICES-003.

CAN ICES-003 (A) / NMB-003 (A)

HDMI Trademark Statement

The terms HDMI, HDMI High-Definition Multimedia Interface, and the HDMI Logo are trademarks or registered trademarks of HDMI Licensing Administrator, Inc.



PSE

This product is PSE compliant.



RoHS

This product is RoHS compliant.

User Information

Online Registration

Be sure to register your product at our online support center:

International	http://eservice.aten.com
---------------	---

Telephone Support

For telephone support, call this number:

International	886-2-8692-6959
China	86-400-810-0-810
Japan	81-3-5615-5811
Korea	82-2-467-6789
North America	1-888-999-ATEN ext 4988 1-949-428-1111

User Notice

All information, documentation, and specifications contained in this manual are subject to change without prior notification by the manufacturer. The manufacturer makes no representations or warranties, either expressed or implied, with respect to the contents hereof and specifically disclaims any warranties as to merchantability or fitness for any particular purpose. Any of the manufacturer's software described in this manual is sold or licensed *as is*. Should the programs prove defective following their purchase, the buyer (and not the manufacturer, its distributor, or its dealer), assumes the entire cost of all necessary servicing, repair and any incidental or consequential damages resulting from any defect in the software.

The manufacturer of this system is not responsible for any radio and/or TV interference caused by unauthorized modifications to this device. It is the responsibility of the user to correct such interference.

The manufacturer is not responsible for any damage incurred in the operation of this system if the correct operational voltage setting was not selected prior to operation. PLEASE VERIFY THAT THE VOLTAGE SETTING IS CORRECT BEFORE USE.

Product Information

For information about all ATEN products and how they can help you connect without limits, visit ATEN on the Web or contact an ATEN Authorized Reseller. Visit ATEN on the Web for a list of locations and telephone numbers:

International	http://www.aten.com
North America	http://www.aten-usa.com

Package Contents

Check to make sure that all the components are in working order. If you encounter any problem, please contact your dealer.

- ◆ 1 VP3520 5 x 2 True 4K Seamless Presentation Matrix Switch with Control
- ◆ 1 IR receiver
- ◆ 1 IR remote control
- ◆ 1 power cord
- ◆ 3 2-pole terminal blocks
- ◆ 3 3-pole terminal blocks
- ◆ 1 4-pole terminal block
- ◆ 1 rack mount kit
- ◆ 1 foot pad set (4 pcs)
- ◆ 1 user instructions

Table of Contents

Compliance Statements	ii
User Information	iv
Online Registration	iv
Telephone Support	iv
User Notice	iv
Product Information	v
Package Contents	vi
Table of Contents	vii
About this Manual	x
Conventions	xi
Terminology	xi

1. Introduction

Overview	1
Features	2
Planning the Installation	4
Required Equipment	4
Optional Equipment	4

2. Hardware Setup

Hardware Overview	5
Front View	5
Rear View	6
IR Remote Control	8
Mounting	9
Rack Mount	9
Installation	10
Relay Connection	12
Setting Up Controls to a Projector Screen	13
RS-232 Serial Connection	15
IR Serial Connection	16

3. Local Operation

Overview	17
Operation Considerations	17
Switching Sources	17
Display Mode	18
Audio Settings.	18
Enabling / Disabling the Panel Lock	19
Power LED Indication	20
Customizing Remote Control to Function Keys	22

4. Remote Operation

Overview	25
Default Network and Login Settings	25
Supported Web Browsers	26
Logging In the Web Console	27
The Main Screen	28
Function Key	29
General Settings	30
Audio & Video Settings	32
Video Control Settings	32
Audio Control Settings	36
Audio Output	37
Audio Input	37
Display Control Settings	39
HDCP Settings	43
Function Key Settings	44
System Settings	49
Maintenance Settings	49
Upgrading the System Firmware	49
Backing Up System Settings	50
Restoring System Settings	50
Resetting the Default Settings	50
Network Settings	51
IP Settings	51
Browser	51
IP Installer	52
Configuration Settings	53
Configuring Display A and Display B	53
Configuring RS-232 Serial and RS-232 HDBT Out	54
Configuring IR Serial and IR HDBT Out	55
Configuring PJ-Link	56
Configuring Relay 1 and Relay 2	56

5. CLI Commands

Overview	57
Connecting to the VP3520 via Telnet	57
Connecting to the VP3520 via RS-232	58
Command Syntax	59
Command List	60
Port Numbers	60
Setting the Display Mode	61
Enabling or Disabling the Echo Function	61
Setting the EDID Mode	62
Configuring the Mute Function	62
Configuring the Read Status	63
Resetting the Unit	64
Configuring the Scaling	64

Enabling or Disabling the Standby Mode	65
Switching Sources.	65
Configuring the Switching Mode	66
Configuring the Volume.	66
Setting the Fan Speed	67
Rebooting the Unit	67
Configuring the Audio Mapping	68

6. Video Presentation Control App

Overview.	69
Installing and Configuring the App	69
iOS Version.	70
Main Page	70
Info	71
Joining a Meeting	72
Joining a Meeting Automatically	72
Joining a Meeting via Manually Connect	74
Joining a Meeting via QR Code	76
Control Panel Smartphone	77
Function Key	77
Enabling Standby Mode	78
Disabling Standby Mode	79
Checking the System Version	80
Video Panel	81
Switching a Source for a Display	81
Display Features and Settings	82
Audio Panel	84
Audio Output Settings	84
Audio Input Settings	86

Appendix

Safety Instructions	89
General	89
Rack Mounting	91
Technical Support	92
International	92
North America	92
Specifications	93
Limited Warranty	97

About this Manual

This user manual is provided to help you get the most from the 5 x 2 True 4K Seamless Presentation Matrix Switch with Control and Remote Pad. It covers all aspects of installation, configuration, and operation for the VP3520.

Chapter 1, *Introduction* introduces you to the VP3520. Its purpose, features, benefits, and installation considerations are described.

Chapter 2, *Hardware Setup* introduces the panel components of the 5 x 2 True 4K Seamless Presentation Matrix Switch with Control and the IR Remote Control, and details the steps to quickly and safely install the VP3520.

Chapter 3, *Local Operation* provides information on how to locally operate and access the system settings via the panel pushbuttons and IR remote control.

Chapter 4, *Remote Operation* provides details on remote management and control tasks via the system web interface.

Chapter 5, *CLI Commands* provides details on the functions and RS-232 commands that you can use to control the VP3520 using a serial controller.

Chapter 6, *Video Presentation Control App* provides details on remotely configuring system settings via the ATEN Video Presentation Control App.

Appendix provides a list of safety instructions and precautions, contact information for ATEN technical support, product specifications, and other technical information.

Note:

- ◆ Read this manual thoroughly and follow the installation and operation procedures carefully to prevent any damage to the unit or any connected devices.
 - ◆ The product may be updated, with features and functions added, improved, or removed since the release of this manual. For an up-to-date user manual, visit <http://www.aten.com/global/en/>
-

Conventions

This manual uses the following conventions:

- Monospaced Indicates text that you should key in.
- [] Indicates keys you should press. For example, [Enter] means to press the **Enter** key. If keys need to be chorded, they appear together in the same bracket with a plus sign between them: [Ctrl+Alt].
1. Numbered lists represent procedures with sequential steps.
- ◆ Bullet lists provide information, but do not involve sequential steps.
- > Indicates selecting the option (on a menu or dialog box, for example), that comes next. For example, Start > Run means to open the *Start* menu, and then select *Run*.
-  Indicates critical information.

Terminology

Terminology	Description
Phantom Power	The phantom is deigned to power the condenser microphones without using bulky external power supply cables.
IR Learning	The IR leaning can be used for learning and restoring control code to reduce clutter and provide a specialized remote control solution.
Dynamic Microphone	A dynamic microphone is often used in a live setting where volume levels might be higher.
Condenser Microphone	A condenser microphone is usually used in a studio environment to pick up detailed up subtle, nuanced sounds instead of loud and abrasive sounds.
Seamless Switch™	Features close-to-zero second switching for continuous video streams, real-time switching, and stable signal transmissions.

This Page Intentionally Left Blank

Chapter 1

Introduction

Overview

The ATEN VP3520 is a multi-in-one presentation matrix switch that integrates a video matrix switch, 4K scaler, HDBaseT extender, and audio DSP functions into one compact device that easily mounts under a table or in a rack. The VP3520 seamless presentation matrix switch with control features the true 4K video resolutions of 4096 x 2160 / 3840 x 2160 @ 60 Hz (4:4:4) and HDR technology, guaranteeing crystal-clear images across two displays. The VP3520 supporting 4K @ 60 Hz, HDMI, and HDCP 2.2 features Seamless Switch™ that employs an FPGA matrix architecture that ensures continuous video streams, real-time control, and stable signal transmissions. With a built-in high-performance 4K scaler, the VP3520 easily converts various input resolutions into various output display resolutions, giving viewers the best video and picture quality across the two displays.

With flexible audio de-embedding, the VP3520 is designed with the audio routing flexibility to meet different application requirements. In a simple setup, HDMI audio can be connected and switched directly to display audio. For a more complex setup, the HDMI audio can be de-embedded to Audio Line Out in order to connect to your preferred in-room audio equipment. Equipped with 5 digital inputs to one HDBaseT and one HDMI True 4K separate outputs, the VP3520 enables users to control 2 displays at the same time and is designed to boost the efficiency and impact of professional presentations. The VP3520 provides users with the flexibility of using both active and passive speakers with its stereo line out port, coaxial port, and 2 x 10 W power amplifiers.

As for the control functions, the VP3520 offers users multiple control options through the front-panel pushbuttons, IR remote control, RS-232 commands, web-based GUI, and ATEN Video Presentation Control App. Moreover, the VP3520 enables the control of AV devices such as TV displays, projectors, and monitors. It is ideal for all meeting space and education environments, including huddle rooms, classrooms, training rooms, or any other presentation setting such as in exhibition galleries or hotels.

Features

Display Control

- ◆ Auto display on / off control — supports display control through CEC, IR, RS-232, PLink and to control projector screen through relay port
- ◆ Flexible control methods — triggered by source detection or 4 function keys on front panel.

Digital AV Matrix Switching

- ◆ Supports multi-format 5 Inputs — 3 HDMI, 2 HDBaseT
- ◆ 1 HDMI and 1 HDBaseT output
- ◆ Audio embedding — stereo audio can be embedded into display output or separated to stereo line out and coaxial audio output
- ◆ Audio de-embedding — HDMI / HDBaseT audio can be extracted to stereo line out
- ◆ Built-in Audio DSP — supports microphone input with selectable 48 V Phantom Power and allows microphone input to be mixed with program audio and embedded into display output
- ◆ Automatically reduces program audio when a microphone signal is detected
- ◆ Auto switching — automatically detects and switches to a new source as soon as it is connected
- ◆ Audio amplifier — 2 x 10 W built-in power amplifier with speaker outputs on terminal block connectors

High-definition Video with Optimum Output

- ◆ Superior video quality — True 4K resolutions up to 4096 x 2160 @ 60 Hz (4:4:4) (HDMI) / 4096 x 2160 @ 60 Hz (4:2:0) (HDBaseT)
- ◆ Supports 4K HDR
- ◆ 4K Scaler — features a 4K video scaler to convert input resolutions to the optimum display resolutions
- ◆ Seamless Switch™ — features close-to-zero second switching for continuous video streams, real-time switching, and stable signal transmissions
- ◆ EDID Expert™ — automatically selects the optimum EDID settings for smooth power-up, high-quality display, and the best video resolution across connected devices
- ◆ HDMI; HDCP 2.2 compliant

Versatile, Streamlined Operation

- ◆ Multiple control options — flexible control via front-panel pushbuttons, IR remote control, RS-232, and web-based GUI through Ethernet
- ◆ View the device status and control it via ATEN Video Presentation Control App in a swift and agile way
- ◆ RS-232 and IR channel — allows AV device control over HDBaseT connection without additional cabling
- ◆ Supports stand-by mode for power saving and fast waking up
- ◆ Consumer Electronics Control (CEC) support

Note: For more information on the ATEN Video Presentation Control App, see *ATEN Video Presentation Control App User Manual*.

Extended Transmission over One Cable

- ◆ Power over HDBaseT (PoH) — remote powering over existing communication cable with selectable powering device
- ◆ Long-distance transmission — transmits digital AV signal, RS-232 commands, and IR control signals up to 70 m* via Cat 6 / 6a or ATEN 2L-2910 Cat 6 cables through HDBaseT Out port

Note: This is achieved using both the HDBaseT In and the HDBaseT Out ports on the VP3520 with each extending the transmission up to 70 m.

Planning the Installation

Required Equipment

Prepare the following equipment before installing the VP3520.

- ◆ Up to 3 input devices equipped with HDMI ports and 2 input devices equipped with an HDBaseT port
- ◆ Up to 2 display devices, one equipped with an HDMI port and the other equipped with an HDBaseT port

Optional Equipment

Prepare the following equipment as required.

- ◆ 1 microphone
- ◆ 1 media player
- ◆ 1 active speaker
- ◆ 1 video transmitter and 1 receiver equipped with HDBaseT ports for signal extension
- ◆ 1 Ethernet cable to connect the VP3520 to a network switch for remote management via the web console
- ◆ 1 host computer, ATEN Controller, or third-party control system that supports RS-232 or Telnet
- ◆ Mounting kits:
 - ◆ Rack mount kit

Chapter 2

Hardware Setup



1. Please review the safety information regarding the placement of this device in *Safety Instructions*, page 89.
2. Do not power on the VP3520 until all the necessary hardware is connected.

Hardware Overview

Front View

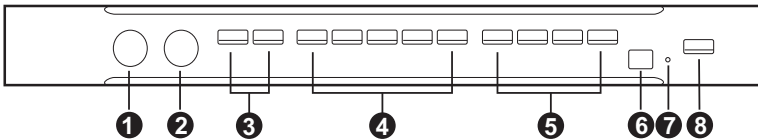

No.	Component	Description
1	mic volume control	Use the knob to adjust the microphone volume.
2	overall volume control	Use the knob to adjust the volume of all audio outputs.
3	display selection pushbuttons	Press a pushbutton to focus a display. The pushbutton for the focused display lights orange.
4	source selection pushbuttons	Press a pushbutton to select a source for the focused display. The pushbutton for the selected source lights green.
5	function selection pushbuttons	Press a pushbutton to activate a preset IR remote control sequence for the connected display device. See <i>Customizing Remote Control to Function Keys</i> , page 22.
6	IR learn panel	Aim the IR remote control from the connected display device to the IR learn panel to learn its code to customize your remote control solution for the function selection pushbuttons. See <i>Customizing Remote Control to Function Keys</i> , page 22.
7	IR learn LED	The IR learn LED blinks to indicate its status. See <i>Customizing Remote Control to Function Keys</i> , page 22.
8	power pushbutton	Used to power on / off the VP3520, or enable/disable the standby mode. For details, see <i>Power LED Indication</i> , page 20.

Rear View

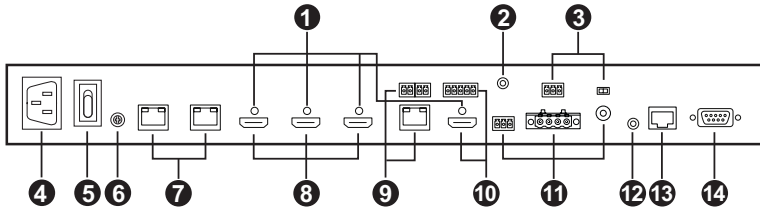

No.	Component	Description
1	cable lock screw for ATEN LockPro™	Universal HDMI cable lock that provides the easiest way to secure an HDMI cable to most HDMI devices.
2	audio input port	Receives a line-in audio source.
3	mic input ports	Connects to a microphone. To use the phantom power for dynamic microphone, set PHANTOM switch to ON .
4	power socket	Receives a power cord to supply power to the VP3520.
5	power switch	Enables or disables the power supply to the VP3520.
6	grounding terminal	Grounds the VP3520 to prevent damages from power surge or static electricity.
7	source 1, 2	Connect to a source device at a distance via a Tx device equipped with an HDBaseT port. Note: These HDBaseT input ports support PoH (Power over HDBT)
8	source 3, 4, and 5	Connect to HDMI source devices via HDMI cables.
9	output / Display A	Connects to an Rx device which in turn connected to a display device at a distance. Note: These HDBaseT output ports support PoH (Power over HDBT)
	HDBaseT output port	
10	relay port 1 & 2	Connect to the project's screen to bring the screen up and down.
	output / Display B	Connects to an HDMI-enabled display device.
	HDMI output port	
	RS-232 port	Connects to the display for control via RS-232 serial commands using a RS-232 terminal block.
	IR port	Connects to the display for control via IR remote control using a RS-232 terminal block.

No.	Component	Description
11	stereo line output ports	Connects to a set of active speakers.
	Lo-Z output ports	Connects to a set of passive speakers.
	coaxial output port	Connects to a coaxial input device.
12	IR receiver port	Connects to an IR receiver to receive IR signals from the IR remote control.
13	Ethernet port	Connects to a network switch via an Ethernet cable to allow remote operation via the web console.
14	RS-232 serial port	Connects to a hardware or software controller to transmit serial data.

IR Remote Control

To operate the VP3520, insert the supplied IR receiver to the IR receiver port on the back panel of the VP3520.

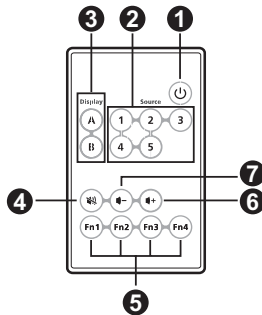

No.	Buttons	Description
1	on / off	Used to power on the VP3520 and enable / disable the standby mode. For details, see <i>Power LED Indication</i> , page 20.
2	source	Press a source button to switch the focused display to the source.
3	display	Press a display button to focus the display.
4	mute	Press the button to mute all displays and speakers.
5	functions	Press the function pushbuttons to select a pre-configured IR remote commands to control the connected display.
6	volume up	Press the set the volume up.
7	volume down	Press to set the volume down.

Mounting

Rack Mount

The VP3520 can be mounted on a 19" (1U) system rack. To conveniently access the front panel for local configuration and operation, mount the unit in a rack with the front panel facing outward.

To rack mount the VP3520, follow the steps below.

1. Use the M3 Phillips hex head screws supplied with the mounting kit to secure the rack mount brackets onto the unit.

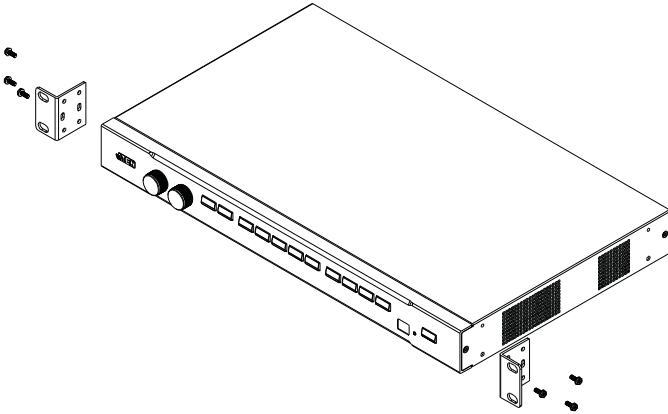

2. Position the unit in the front of the rack and align the holes in the mounting brackets with the holes in the rack.
3. Secure the mounting brackets to the rack using self-prepared screws.

Installation

Follow the steps below the safely install sources, displays, and other equipment to the VP3520.

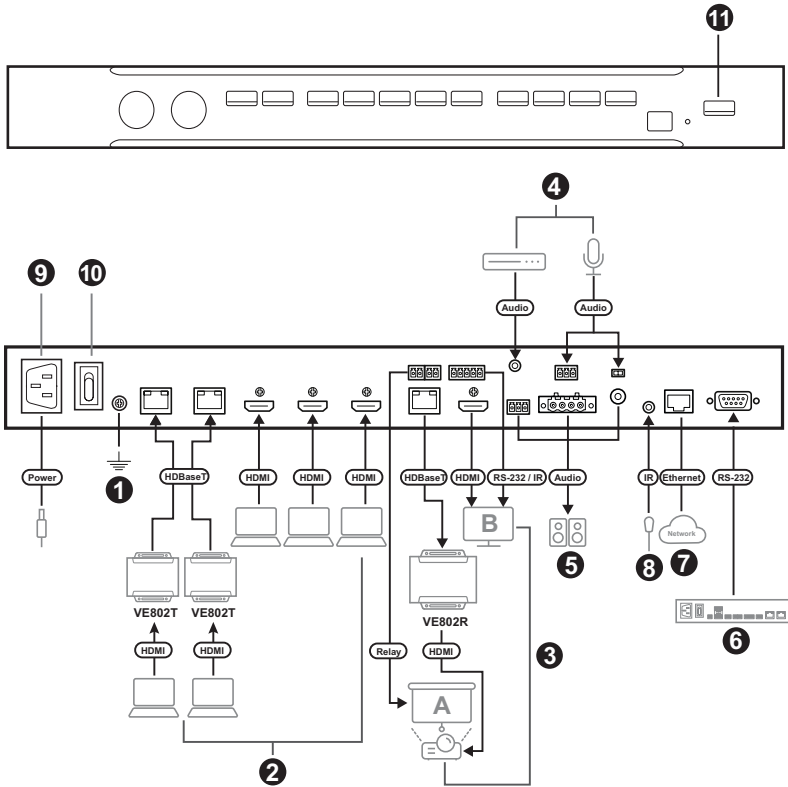

1. Use a grounding wire to ground the unit by connecting one end to the grounding terminal, and the other end of a suitable ground object.

Note: Do not omit this step. Proper grounding helps prevent damage to the unit from power surges or static electricity.

2. Connect up to 5 video sources to the unit.
 - ◆ To connect a video source device via a video extender, connect the video extender (e.g., VE802T) to the VP3520 using an Ethernet cable.
 - ◆ To connect an HDMI source device, connect the source device to the VP3520 using an HDMI cable. You can connect up to 3 HDMI source devices.
3. Connect up to 2 displays to the unit.
 - ◆ To set up a display at a distance, connect a suitable Rx device (e.g., VE802R) to the VP3520 using an Ethernet cable, to which the display (e.g., projector) is connected. To remotely control the connected projector's screen up and down, connect the screen to the relay ports. For wiring information, see *Relay Connection*, page 12.
 - ◆ Connect the unit to an HDMI display using an HDMI cable. To remotely control the connected display, connect the RS-232 and IR ports to the display. For wiring information, see *RS-232 Serial Connection*, page 15 and *IR Serial Connection*, page 16.
4. (Optional) To supply independent audio, connect an audio source device (e.g., media player) or a microphone to the VP3520.
5. (Optional) Connect the VP3520 to a speaker via an appropriate output port.
6. (Optional) To configure the unit's settings via RS-232 commands, connect a hardware controller (e.g., ATEN Control Box) to the VP3520.
7. (Optional) To allow access to the web interface, connect a network switch to the VP3520 using an Ethernet cable.
8. (Optional) To control the VP3520 using an IR remote control, connect the IR receiver to the VP3520.
9. Plug the power cord to the power socket.
10. Put the power switch to **ON**.
11. Press the **power pushbutton** to power on the VP3520.
12. Power on all the connected devices.

Relay Connection

These 2 relay channels provide connections to control the project's screen. Each relay is normally open by default.

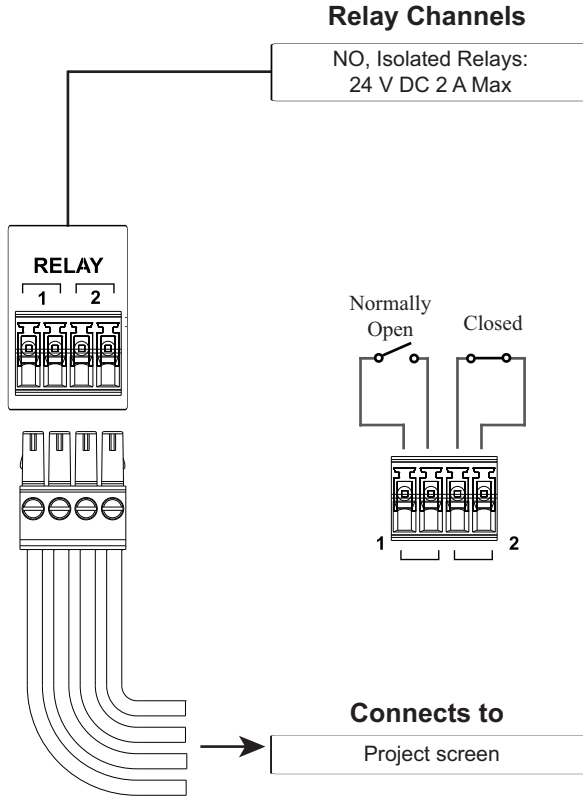

Setting Up Controls to a Projector Screen

To automatically bring the projector's screen up and down by detection of source device, follow the steps below.

- 1. Connect a suitable Rx device (e.g., VE802R) to the VP3520 using an Ethernet cable, to which the display (e.g., projector) is connected.
- 2. To automatically bring the screen down when an input source device is detected by the VP3520, follow the steps below.
 - a) Connect the screen to the unit's relay port 1.

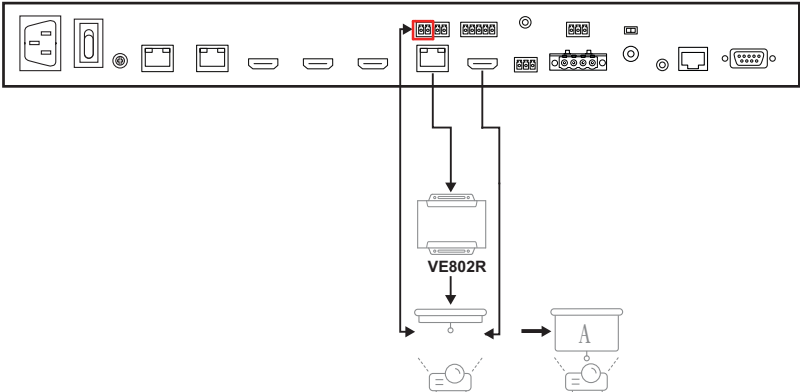

- b) Log in the web console, go to **Audio & Video > Display Control**, and then check **Enable Screen Up(Relay 1)**.

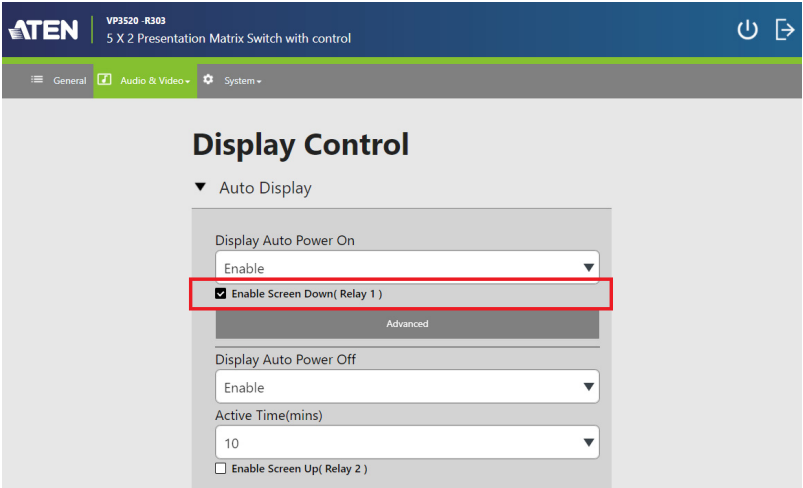

- To automatically bring the screen up when an input source device is removed and undetected by the VP3520 for a specified active time, follow the steps below.

a) Connect the screen to the unit's relay port 2.

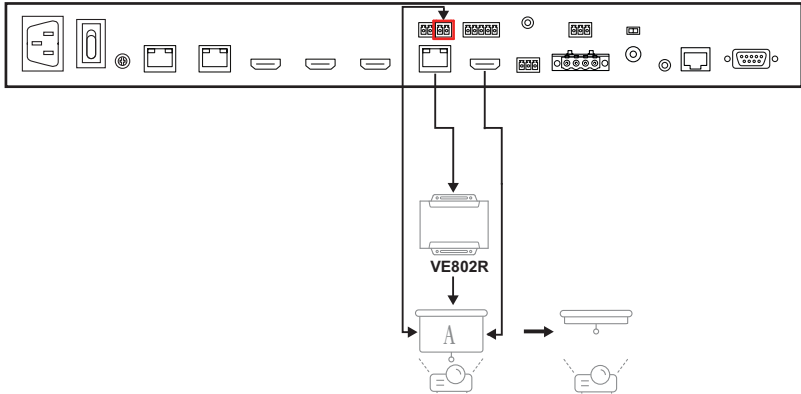

b) Log in the web console, go to **Audio & Video > Display Control**, and then check **Enable Screen Up(Relay 2)**.

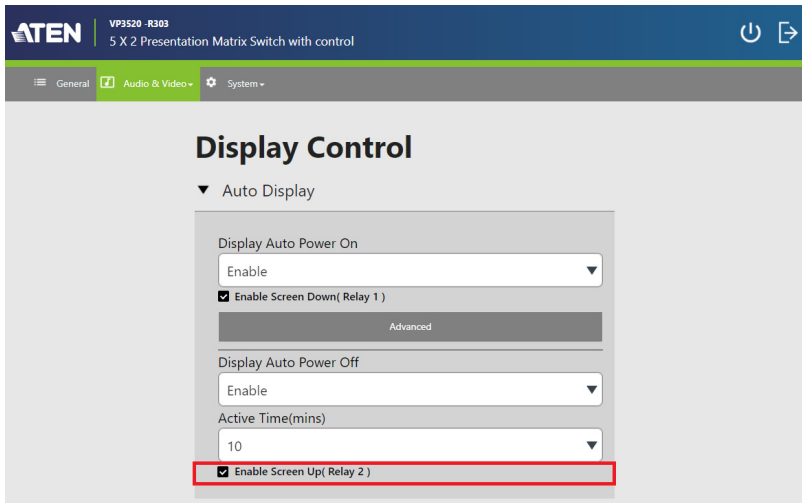

RS-232 Serial Connection

The bidirectional RS-232 ports on the VP3520 provide serial control of the connected HDMI display. For bidirectional RS-232 control, the transmit, receive, and ground pins must be wired on both the VP3520 and the HDMI display. Please consult the HDMI display's manual for wiring details.

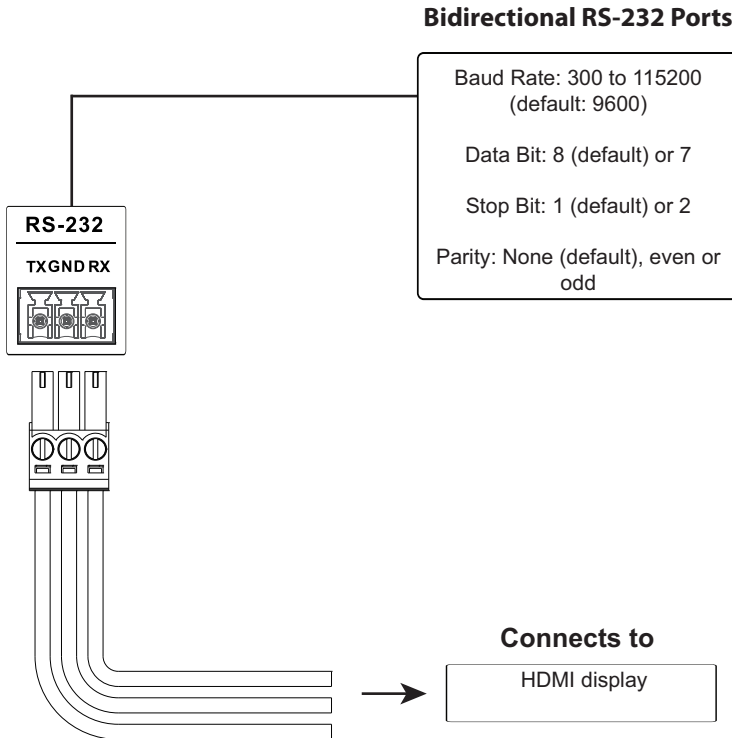

IR Serial Connection

The IR ports on the VP3520 provide IR remote control of the connected HDMI display.

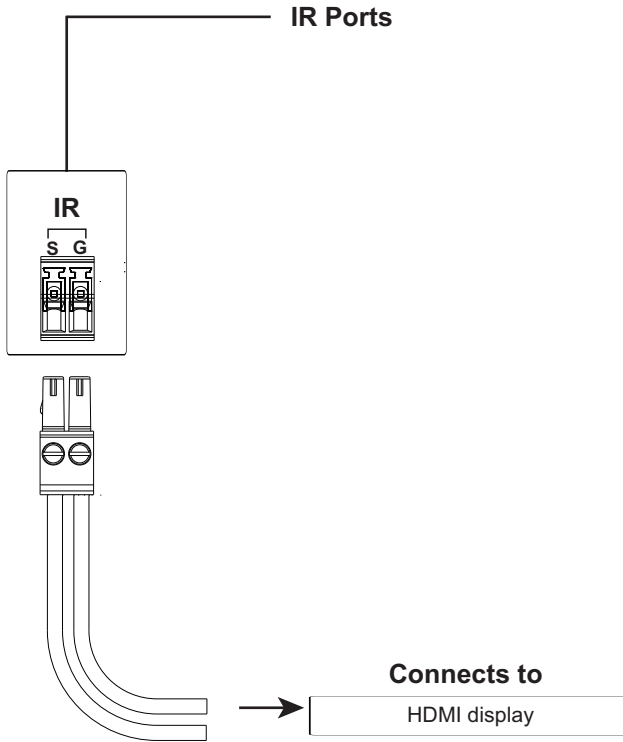

Chapter 3

Local Operation

Overview

This chapter provides information on operating the VP3520 using the front panel and IR remote control.

Note: The instructions use *pushbutton* to refer to the front panel and *button* to refer to the IR remote control.

Operation Considerations

- ♦ To use the IR remote control, make sure to insert the IR receiver (supplied in the package) to the VP3520.
- ♦ To ensure smooth operation using the IR remote control, use the IR remote control within the effective range (6 m) and keep a clear line-of-sight between the remote control and the IR receiver connected to the VP3520.

Switching Sources

To switch the video source on a display:

1. Press a **display selection** pushbutton (VP3520 front panel) / button (IR remote control) to select a display. The pushbutton (VP3520 front panel) for the selected display lights orange.
2. Press a **source selection** pushbutton (VP3520 front panel) / button (IR remote control) to assign the source. The pushbutton (VP3520 front panel) for the selected source lights orange.

Note:  appears on the top left corner of the OSD for 5 seconds when the source is switched. This is the resolution from the original source without scaling.

Display Mode

The VP3520 supports the following display modes:

- ◆ **Matrix mode** (

Audio Settings

- ◆ To adjust the volume for all audio outputs on the VP3520, use the **volume** knob on the front panel or the **volume up** or **volume down** buttons on the IR remote control.
- ◆ To adjust the volume of a microphone or an independent audio source on the VP3520, use the **mic** knob on the front panel.
- ◆ To mute all audio outputs (displays and speaker), press the **volume** knob on the front panel or press the **mute** button on the IR remote control.

Enabling / Disabling the Panel Lock

To prevent accidental tampering of system settings via the front panel, you can lock the panel by pressing the **function selection pushbutton 4 (Fn4)** for set up an idle time for an auto lock via the web console (**General > Basic > Panel Auto Lock**). Refer to the table below for how to enable / disable the panel lock and the corresponding LED indication.

Task	Lock LED  (Mode Pushbutton)
To lock the front panel, press and hold the function selection pushbutton 4 (Fn4) for about 3 seconds.	Lights red
To unlock the front panel, press and hold the function selection pushbutton 4 (Fn4) pushbutton for about 3 seconds.	Dims
If any front panel pushbutton / knob is adjusted when the panel is locked.	Flashes 3 times

Note: If you have locked the panel using the **function selection pushbutton 4 (Fn4)**, make sure to unlock only by pressing the **function selection pushbutton 4 (Fn4)**. Disabling panel lock from the web console will not be effective in this case.

Power LED Indication

The power pushbutton is equipped with an LED that indicates the power status of the VP3520. Refer to the table below for the status and supported tasks for each LED indication.

LED Indication (Power Pushbutton)	VP3520 Status	Tasks
Dim	The VP3520 is powered off.	To power on the VP3520, press the power pushbutton (VP3520 front panel) / power button (IR remote control) once.
Flashes orange	The VP3520 is loading system information.	Wait for the unit to finish loading information.
Orange	The VP3520 is in standby mode.	<p>The standby mode is a power-saving mode that shuts parts of the system down to allow the user to quickly resume operation when needed.</p> <p>To awake the VP3520, press the power pushbutton (VP3520 front panel) / power button (IR remote control) once.</p> <p>Note: To power off the VP3520 when it is in standby mode, awake the unit first, and then follow the steps in the next entry to power off the unit.</p>
Flashes green	The VP3520 is busy running remote control processes.	Wait for the unit to finish running remote control processes.

LED Indication (Power Pushbutton)	VP3520 Status	Tasks
Green	The VP3520 is awoken.	<ul style="list-style-type: none">◆ To enable the standby mode to conserve power, press the power pushbutton (VP3520 front panel) / power button (IR remote control) once.◆ To power off the unit: (1) Press and hold the power pushbutton for 3 seconds. A confirmation message appears in the OSD. (2) Press the power pushbutton once. The VP3520 powers off. Note: The remote control can not be used to power off the VP3520.

Customizing Remote Control to Function Keys

To control a connected display device using the function selection pushbuttons, follow the steps below to set up the function keys.

1. Log in the web console, go to **Audio & Video > Function Key**.
2. Use the drop-down menu to select **Enable**, and click **Create New**.

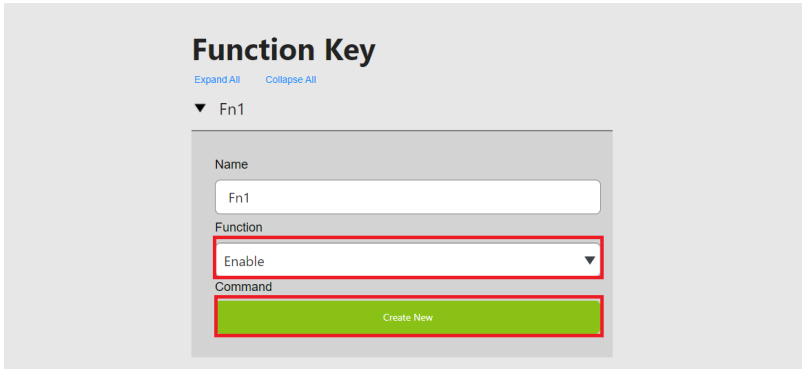

3. In the pop-up dialog box, use to drop-down menu to select IR Serial or IR HDBT Out, enter a command name, and click **Learn** to enter the IR learning mode.

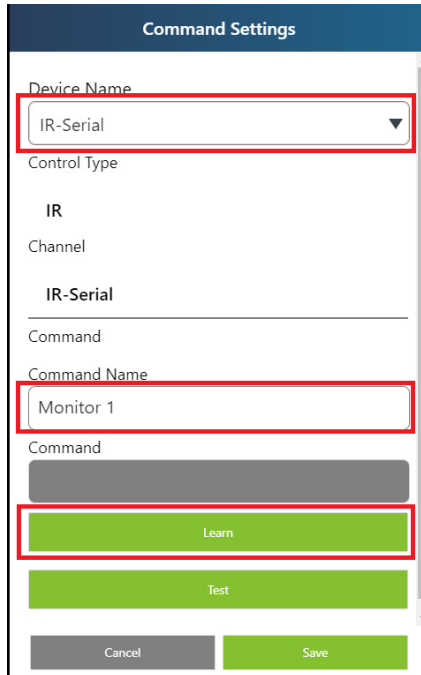

4. The IR learn LED on the unit's front panel flashes for 10 seconds. Aim your display's IR remote control to the IR learn LED on the unit. Press the button you would like to learn from your display's IR remote until the countdown finishes. You can create up to 10 commands for each function key.
5. Click **Test** to test the recorded commands, and click **Save**.

This page is intentionally left blank.

Chapter 4

Remote Operation

Overview

This chapter provides information on how to remotely operate and configure the VP3520 via the web console.

Default Network and Login Settings

The VP3520 uses the following network settings and login credentials as its default settings.

- ♦ Default network settings

Network Parameter	Default Setting
IP Address	192.168.0.60
Subnet Mask	255.255.255.0
Gateway	192.168.0.1
HTTP Port	80

Note: If the VP3520 is connected to a router that supports DHCP, a dynamic IP address will be assigned to the VP3520 as soon as it connects to the network. Look up the IP address by sending a read command via an RS-232 serial controller. For more details, see *Chapter 5, CLI Commands*.

- ♦ Default login credentials

Login Credential	Default Setting	Limitations
Username	administrator	5 to 30 characters in length without special characters, not case-sensitive
Password	password	

Supported Web Browsers

The VP3520 supports access to its web UI through the following web browsers and operating systems:

Operating System	Web Browser	Supported Version
Windows 10 x64	Edge	85.0.564.67 x64
Windows 10 x64	Firefox	88.0 x64
Windows 10 x 64	Chrome	90.0.4430.93 x64
Ubuntu 20.04 x64	Chrome	90.0.4430.93 x64
Solaris 11.4 x64	Firefox	52.9.0_x32
Windows 10 x64_1703_Enterprise	QQ	10.8
Windows 10 x64_1703_Enterprise	360	13.1.1302.0

Logging In the Web Console

1. In a web browser, type the IP address of the VP3520. This screen appears.

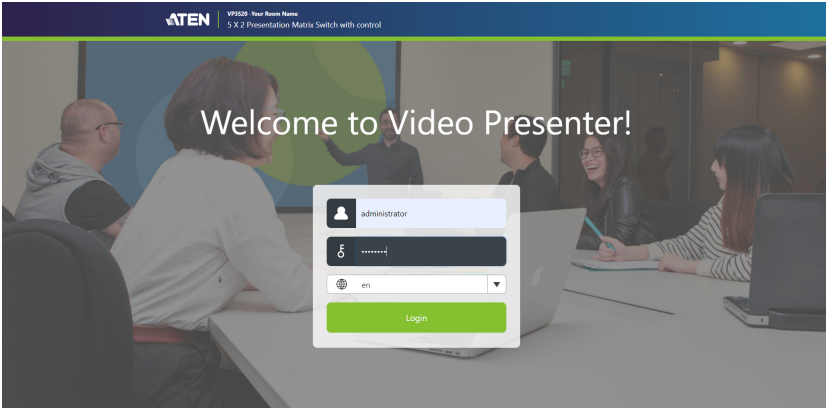



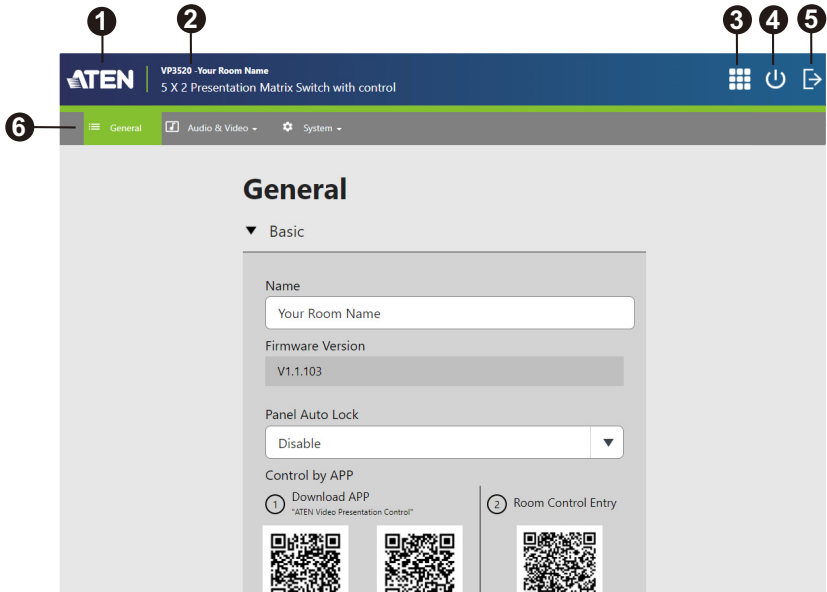

2. Type the username **administrator** and the password.
3. Click **Log In**. The main screen appears.

The Main Screen

The VP3520 defaults to the main screen after logging in. Refer to the illustration and table below for an overview of the web console.



No.	Element	Description
1		Click the ATEN logo to visit ATEN's official website.
2	Device Information	Indicates the device model and name.
3		Click to bring out the function keys table for easy control. See <i>Function Key</i> , page 29.
4		Click this icon enable the standby mode, a power-saving mode that shuts parts of the system down to allow the user to quickly resume operation when needed.
5		Click the icon to log out of the web console.
6	Settings Tab	Click on the tabs to switch between different sets of settings.

Function Key

To bring out the function keys table for easy control, simply click the  from the main screen, and the function keys table below appears,

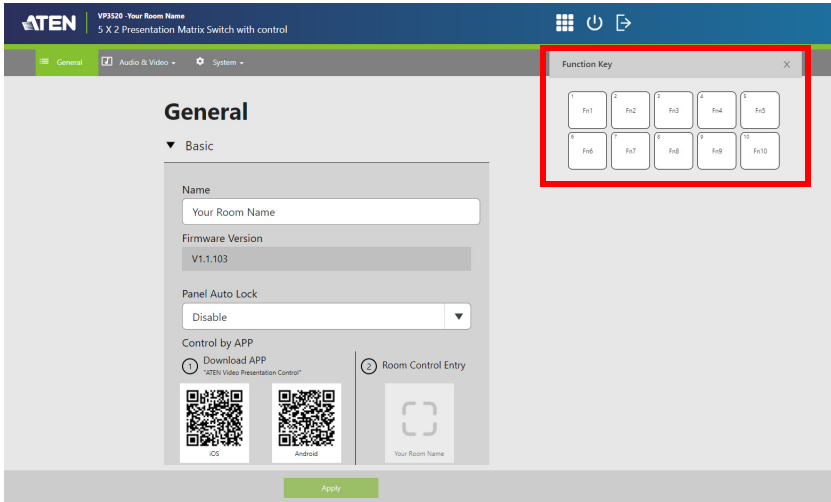

To hide the function keys table, click .

General Settings

The General page includes settings such as device name, panel lock, EDID, and login password. To access the general settings, log in the web console and the screen defaults to the page.

ATEN VP9520 Your Room Name
5 X 2 Presentation Matrix Switch with control

General Audio & Video System

General

▼ Basic

Name
Your Room Name

Firmware Version
V1.1.103

Panel Auto Lock
Disable

Control by APP

1 Download APP
"ATEN Video Presentation Control"

2 Room Control Entry

Download Image Download Image Download Image

EDID
Display A

▼ Change Password

Administrator

Username
administrator

Password
•••••

Confirm Password
•••••

Basic User

Username
123456

Password
•••••

Confirm Password
•••••

Apply

◆ Basic

- ◆ **Name:** Type a name for the VP3520. A valid name should be within 30 characters in length and contains no special characters. This name appears on the web console immediately after the model name:

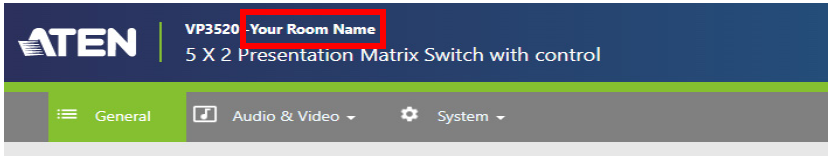

- ◆ **Firmware:** Indicates the firmware version for the VP3520.
- ◆ **Panel Auto Lock:** Sets the idle time for the front panel to be locked.
- ◆ **Controlled by APP:** Allows you to download the ATEN Video Presentation Control App QR codes for both iOS and Android versions, and Room Control Entry QR code for participants.
- ◆ **EDID**
 - ◆ **Display A:** This mode sends the EDID of Display A to the connected sources.
 - ◆ **Display B:** This mode sends the EDID of Display B to the connected sources.
 - ◆ **ATEN Default:** This mode sends ATEN-predefined EDID to the connected sources.
 - ◆ **Remix:** Sends the optimum EDID of the connected displays to the connected sources.
- ◆ **Change Password**
 - ◆ **Administrator:** The administrator account has access to all settings in the web console. The default password is **administrator**.
 - ◆ **Basic User:** A basic user account has access to the audio and video controls on the web console. To create a basic user account, specify the username and password fields here.

Note: A valid password (for the administrator or basic user account) is not case-sensitive and should be 5 to 16 characters in length, without space or special characters.

Audio & Video Settings

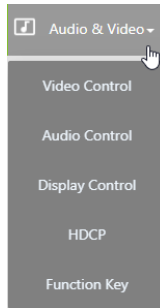

Click  **Audio & Video** for a list of available options under audio and video settings.

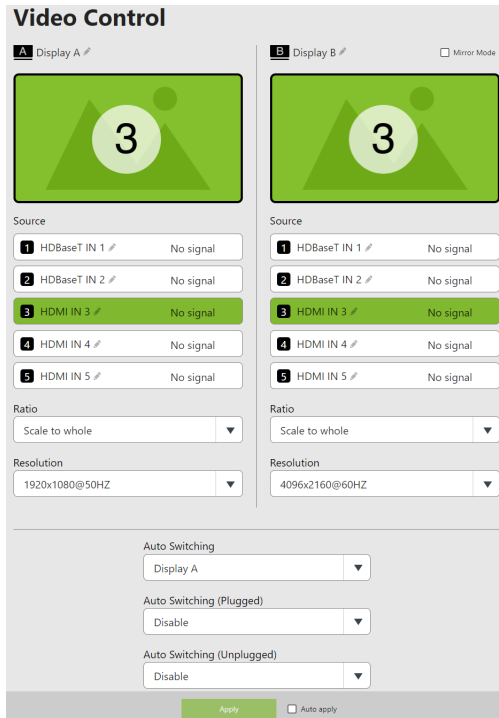

Video Control Settings

Use the video control page to assign video sources and configure video settings. To access the video control page, log in the web console, and then go to **Audio & Video > Video Control**.



- ◆ **Display A / Display B:** Shows a preview of the currently selected source and indicates the source number at the center of the preview. Click  to rename the source.
- ◆ **Mirror mode:** Select this option for display B to show identical video content as display A.
- ◆ **Source:** Lists the connection status of all source ports and the currently assigned source (indicated in green).
 - ◆ To switch the source for the display, click on one of the listed sources. The assigned source is highlighted green.
 - ◆ To rename the source, click .
- ◆ **Ratio:**
 - ◆ **Scale to whole:** Fully extends the video to the four sides of the display.
 - ◆ **Auto fit:** Proportionally scales the video to fit the display without cutting any content off. This may leave some blank on either the top and bottom or the left and right of the screen.
 - ◆ **Auto cut:** Proportionally scales the video to fully fill the display. The content that goes out of the display range will be cut off.
- ◆ **Resolution:** Click the drop-down list to select a resolution and refresh rate setting for the display device. This field is only available when the display is connected to the VP3520. Make sure to select the correct display resolution for the connected display, otherwise the display will not display any content.

560x360@60HZ
720x576@50HZ
768x480@60HZ
800x600@60HZ
1024x768@60HZ
1280x720@50HZ
1280x720@60HZ
1280x800@60HZ
1280x1024@60HZ
1366x768@60Hz
1400x1050@60HZ
1600x900@60HZ
1600x1200@60HZ
1920x1080@30HZ
1920x1080@50HZ
1920x1080@60HZ
1920x1200@60HZ
2560x1080@60HZ
3440x1440@50HZ
3840x2160@24HZ
3840x2160@25HZ
3840x2160@30HZ
3840x2160@50HZ 4:2:0
3840x2160@60HZ 4:2:0
4096x2160@24HZ
4096x2160@25HZ
4096x2160@30HZ
4096x2160@50HZ 4:2:0
4096x2160@60HZ 4:2:0
3840x2160@24HZ 4:2:2 12bit
3840x2160@25HZ 4:2:2 12bit
3840x2160@30HZ 4:2:2 12bit
4096x2160@24HZ 4:2:2 12bit
4096x2160@25HZ 4:2:2 12bit
4096x2160@30HZ 4:2:2 12bit
1280x768@60HZ
1920x1120@60HZ

- ◆ **Auto switching:** Enables the auto switching of audio-video source on Display A or Display B.
- ◆ **Video Switching (Plugged):** Defines the automatic switching of audio-video source on the selected display from the auto switching above when a new source is plugged in.
 - ◆ **Disable:** Disable automatic switching.
 - ◆ **Next:** Automatically switches to the next available source when the current video source is plugged in.
- ◆ **Video Switching (Unplugged):** Defines the automatic switching of audio-video source on the selected display from the auto switching above when a previously used source goes detected.
 - ◆ **Disable:** Disable automatic switching.
 - ◆ **Next:** Automatically switches to the next available source when the current video source is plugged out.
 - ◆ **Last:** Automatically switch the display to the previous available source based on the order of source connection. For example, if sources are connected to the VP3520 in the order of port 2, port 3, port 4 and then port 1, and that selected display from the auto switching above is switched to port 3, when the source (port 3) is unplugged, the selected display from the auto switching above will automatically switch to port 1.

Apply vs. Auto Apply

To automatically apply the changes you make on the Video Control page, select **Auto apply** at the bottom of the page.

Audio Control Settings

To access the audio control page, log in the web console, and then go to **Audio & Video > Audio Control**.

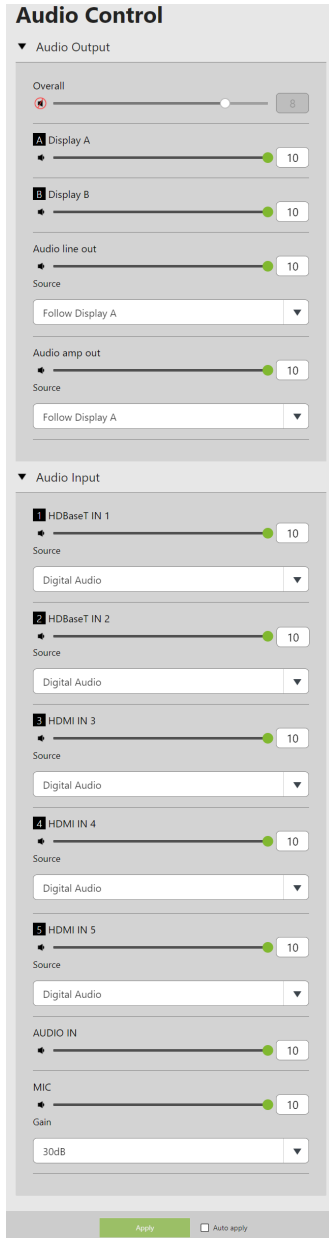

Audio Output

- ◆ **Overall volume:**
 - ◆ Mute, unmute, and set the volume of the connected speaker.
- ◆ **Display A**
 - ◆ Mute, unmute, and set the volume of display A.
- ◆ **Display B**
 - ◆ Mute, unmute, and set the volume of display B.
- ◆ **Audio line out**
 - ◆ Mute, unmute, and set the volume of the audio out and coaxial outputs.
 - ◆ **Source:** Sets the audio source for the independent speaker connected to the audio out and coaxial output ports of the VP3520.
 - ◆ To use the same audio source for display A, select **Follow Display A**.
 - ◆ To use the same audio source for display B, select **Follow Display B**.
 - ◆ To use the independent audio source (connected to the audio input ports), select **Audio In**.
- ◆ **Audio amp out**
 - ◆ Mute, unmute, and set the volume of the LoZ output.
 - ◆ **Source:** Sets the audio source for the amplifier connected to the LoZ output port of the VP3520.
 - ◆ To use the same audio source for display A, select **Follow Display A**.
 - ◆ To use the same audio source for display B, select **Follow Display B**.
 - ◆ To use the independent audio source (connected to the audio input ports), select **Audio In**.

Audio Input

- ◆ **HDBaseT In 1 / HDBaseT In 2:** Mute, unmute, and set the volume of the HDBaseT in 1 / HDBaseT in 2 source.
 - ◆ **Source:** Sets the audio source for the HDBaseT in 1 / HDBaseT in 2 source. To use the audio source that comes along with the video, select **Digital Audio**. To use the audio source from the independent audio

source (connected to the audio input ports), select **Embedded Audio In**.

- ◆ **HDMI In 3 / HDMI In 4 / HDMI In5:** Mute, unmute, and set the volume of the HDMI in 3 / HDMI in 4 / HDMI in 5 source.
 - ◆ **Source:** Sets the audio source for the HDMI / 3 HDMI 4 / HDMI 5 source. To use the audio source that comes along with the video, select **Digital Audio**. To use the audio source from the independent audio source (connected to the audio input ports), select **Embedded Audio In**.
- ◆ **Audio in:** Sets the volume of the independent audio source connected to the audio input ports.
- ◆ **Mic volume:** Sets the volume of the microphone connected to the mic input ports.
 - ◆ **Gain:** Sets the volume of the microphone connected to the mic input ports.

Apply vs. Auto Apply

To automatically apply the changes you make on the Audio Control page, select **Auto apply** at the bottom of the page.

Display Control Settings

Use the display control page to control the connected display and their settings. To access the display control page, log in the web console, and then go to **Audio & Video > Display Control**. It is recommended to configure the VP3520's control methods and its settings before configuring the auto display control settings. See *Configuration Settings*, page 53.

Display Control

▼ Auto Display

Display Auto Power On

Enable

Enable Screen Down(Relay 1)

Advanced

Display Auto Power Off

Enable

Active Time(mins)

10

Enable Screen Up(Relay 2)

▼ Display A control Settings

Device Name

Display A

Control Type

CEC

Channel

HDBT Out

Command

Display ON

Display OFF

▼ Display B control Settings

Device Name

Display B

Control Type

CEC

Channel

HDMI Out

Command

Display ON

Display OFF

Apply

- ◆ **Auto Display:** Sets the display auto power on and off function for the connected HDMI and HDBaseT displays.
 - ◆ **Display auto power on:** Enables or disables the display auto power on function. The connected display will automatically power on when the VP3520 detects an input source.
 - ◆ **Enable screen down (Relay 1):** Check to enable the auto screen down function. The connected projector's screen will automatically power on and scroll down when the VP3520 detects an input source.
 - ◆ **Advanced:** Click to select one or more input source for auto power on detection.
 - ◆ **Display auto power off:** Enables or disables the display auto power off function. The connected display will automatically power off when the connected input source on the VP3520 is removed and undetected for a specified active time.
 - ◆ **Active time (mins):** Sets the active time in minutes for the VP3520 to power off the connected display when an input source is removed and undetected for a specified active time.
 - ◆ **Enable screen up (Relay 2):** Check to enable the auto screen up function. The connected projector's display will automatically power off and scroll up when the connected input source on the VP3520 is removed and undetected for a specified active time.
- ◆ **Display A control settings:** Sets the control method for the Display A.
 - ◆ Use the drop-down menu to select a control method for the Display A. Options are Display A / RS-232 Serial / RS-232 HDBT Out / PJ-Link 1 / PJ-Link 2.
 - ◆ Use the control commands to test the display on and off function.
 - ◆ If the Display A control method is selected, the control type (CEC) and Channel (HDBT Out) will be fixed. Click **Display ON** and **Display OFF** to test the commands.

Note: It is not guaranteed that CEC protocol will work on all connected display devices. If the Display ON and/or Display OFF commands do not work on your display, other control methods such as RS-232 serial, RS-232 HDBT out, and PJ-Link can be considered.

- ◆ If the RS-232 Serial or RS-232 HDBT Out control method is selected, select a command type between HEX and ASCII before testing the control commands.

- ◆ If the PJ-Link 1 or PJ-Link 2 control method is selected, set the IP address, port, and password before testing the control commands. To set the IP address, port, and password for the PJ-Link 1 and 2, click **Please set the IP address & password first.**  and the screen below appears. Click **Save** when you have entered the correct IP address, port number, and password. Use the drop-down menu to select a command, and click **Test** to test the selected command.

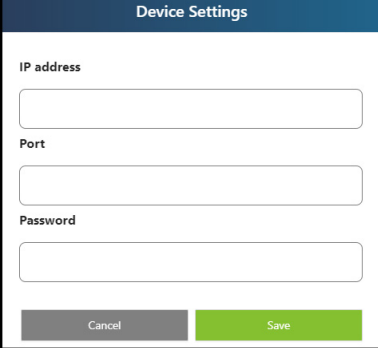

- ◆ **Display B control settings:** Sets the control method for the Display B.
 - ◆ Use the drop-down menu to select a control method for the Display B. Options are Display A / RS-232 Serial / RS-232 HDBT Out / PJ-Link 1 / PJ-Link 2.
 - ◆ Use the control commands to test the display on and off function.
 - ◆ If the Display B control method is selected, the control type (CEC) and Channel (HDMI Out) will be fixed. Click **Display ON** and **Display OFF** to test the commands.

Note: It is not guaranteed that CEC protocol will work on all connected display devices. If the Display ON and/or Display OFF commands do not work on your display, other control methods such as RS-232 serial, RS-232 HDBT out, and PJ-Link can be considered.

- ◆ If the RS-232 Serial or RS-232 HDBT Out control method is selected, select a command type between HEX and ASCII before testing the control commands.
- ◆ If the PJ-Link 1 or PJ-Link 2 control method is selected, set the IP address, port, and password before testing the control commands. To set the IP address, port, and password for the PJ-Link 1 and 2,

click **Please set the IP address & password first.** **Go** and the screen below appears. Click **Save** when you have entered the correct IP address, port number, and password. Click **Save** when you have entered the correct IP address, port number, and password. Use the drop-down menu to select a command, and click **Test** to test the selected command.

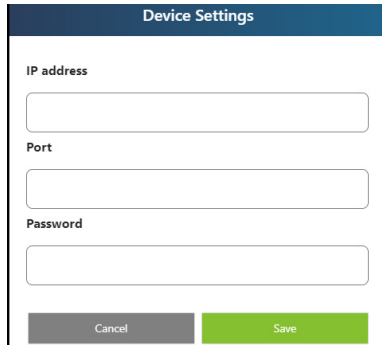

The image shows a 'Device Settings' form. It has a blue header with the text 'Device Settings'. Below the header, there are three input fields: 'IP address', 'Port', and 'Password'. At the bottom of the form, there are two buttons: 'Cancel' (grey) and 'Save' (green).

HDPC Settings

Use the HDPC page to view and set HDPC key setting between input and output ports for digital copy protection and to ensure Seamless Switch™ functionality between different devices. To access the HDPC page, log in the web console, and then go to **Audio & Video > HDPC**.

Input

Here users can select whether port capability is HDCP 2.2, HDCP 1.4 or non-HDCP enabled, either individually or by applying one setting to all ports.

Connection

Here users can find a visual display of connection paths between inputs and outputs. When selecting an input, its path is displayed in green.

Output

Here users can define whether or not HDPC settings are fixed by individual port. By prearranging and fixing keys, this setting ensures that Seamless Switch™ is possible even when switching between HDPC and non-HDCP enabled devices.

HDPC Check

The HDPC Check button (upper-right corner) allows you to check the HDPC capability of the connected displays at one time. They analyses are indicated in the brackets after the Fix HDPC check box for each port.

Apply vs. Auto Apply

To automatically apply the changes you make on the Video Control page, select Auto apply at the bottom of the page.

Function Key Settings

Use the function key page to enable, disable, and configure the function key. You can create up to 4 functions key with 10 commands for each function key. To access the function key page, log in the web console, and then go to **Audio & Video > Function Key**. It is recommended to configure the VP3520's control methods and its settings before using the function keys. See *Configuration Settings*, page 53.

Function Key

[Expand All](#) [Collapse All](#)

▼ Fn1

Name

Function

Command

▼ Fn2

Name

Function

Command

Name

Function

Command

 Auto apply

- ◆ **Expand All:** Fully expands all the function keys with name, function, and command information.

- ◆ **Collapse All:** Hides all the function keys with name, function, and command information. Click on a specific function key to bring up individual name, function, and command information.
- ◆ **FN1 / FN2 / FN3 / FN4 / FN5 / FN 6 / FN7 / FN8 / FN9 / FN10:** Configures the function key name, and enables or disables the function keys.
- ◆ Click **Create New** to create command for different control methods.

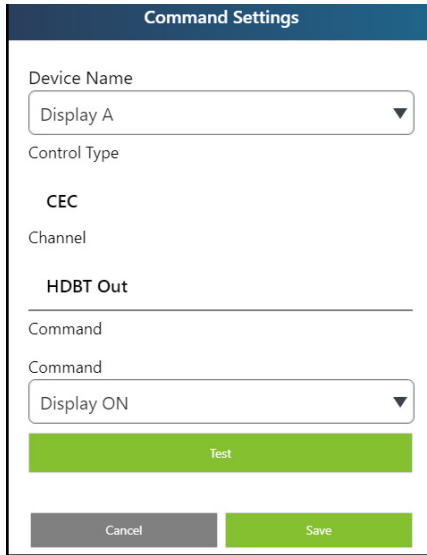

The screenshot shows a 'Command Settings' dialog box. It features a blue header with the title 'Command Settings'. The main content area is white and contains several fields: a 'Device Name' dropdown menu with 'Display A' selected; a 'Control Type' section with 'CEC' selected; a 'Channel' section with 'HDBT Out' selected; and a 'Command' section with a dropdown menu showing 'Display ON'. At the bottom of the dialog, there are three buttons: a green 'Test' button, a grey 'Cancel' button, and a green 'Save' button.

- ◆ Use the drop-down menu to select a control method. Options are Display A (CEC) / Display B (CEC) / RS-232 Serial / RS-232 HDBT Out / IR Serial / IR HDBT Out / PJ-Link 1 / PJ-Link 2 / Relay 1 / Relay 2.
 - ◆ If the Display A or Display B control method is selected, use the drop-down menu to select a command between Display ON or Display Off, and click **Test** to test the selected command.

The screenshot shows a 'Command Settings' dialog box with the following fields and options:

- Device Name:** A dropdown menu with 'Display A' selected.
- Control Type:** A dropdown menu with 'CEC' selected.
- Channel:** A dropdown menu with 'HDBT Out' selected.
- Command:** A dropdown menu with 'Display ON' selected.
- Buttons:** A green 'Test' button, a grey 'Cancel' button, and a green 'Save' button.

- ◆ If the RS-232 Serial or RS-232 HDBT Out control method is selected, enter a command name, select a command type between HEX and ASCII, and key-in the command. Click **Test** to test the command you just created.

The screenshot shows a 'Command Settings' dialog box for RS232 with the following fields and options:

- Device Name:** A dropdown menu with 'RS232-Serial' selected.
- Control Type:** A dropdown menu with 'RS232' selected.
- Channel:** A dropdown menu with 'RS232-Serial' selected.
- Command Name:** An empty text input field.
- Type:** A dropdown menu with 'HEX' selected.
- Command:** An empty text input field.
- Buttons:** A green 'Test' button, a grey 'Cancel' button, and a green 'Save' button.

- ◆ If the IR Serial or IR HDBT Out control method is selected, enter a command name, and click **Learn**. Follow the procedures explained in *Setting Up Controls to a Projector Screen*, page 13 to create up to 10 commands for the assigned function key. Click **Test** to test the command you just created.

Command Settings

Device Name
IR-Serial

Control Type

IR

Channel
IR-Serial

Command

Command Name

Command

Learn

Test

Cancel Save

- ◆ If the PJ-Link 1 or PJ-Link 2 control method is selected, set the IP address, port, and password by clicking

Please set the IP address & password first. **Go** and the screen below

appears. Click **Save** when you have entered the correct IP address, port number, and password. Use the drop-down menu to select a command, and click **Test** to test the selected command.

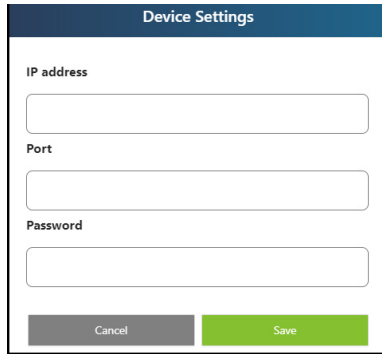

The 'Device Settings' form has a blue header with the title 'Device Settings'. Below the header, there are three input fields: 'IP address', 'Port', and 'Password'. At the bottom of the form, there are two buttons: a grey 'Cancel' button and a green 'Save' button.

- ◆ If the Relay 1 or Relay 2 control method is selected, simply click **Test** to test the command.

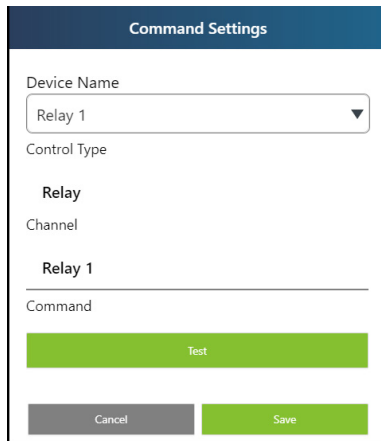

The 'Command Settings' form has a blue header with the title 'Command Settings'. Below the header, there is a 'Device Name' dropdown menu with 'Relay 1' selected. Underneath, there is a 'Control Type' section with 'Relay' selected. Below that, there is a 'Channel' section with 'Relay 1' selected. At the bottom of the form, there are three buttons: a grey 'Cancel' button, a green 'Test' button, and a green 'Save' button.

Apply vs. Auto Apply

To automatically apply the changes you make on the Video Control page, select Auto apply at the bottom of the page.

System Settings

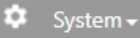
Click  for a list of available options under system settings.

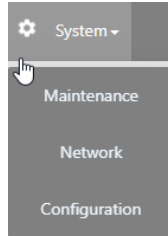

Maintenance Settings

Use the maintenance page to upgrade system firmware, back up or restore system configurations, and restore default settings. To access the maintenance page, log in the web console, and then go to **System > Maintenance**.

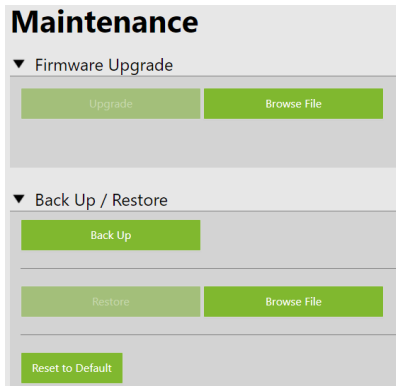

Upgrading the System Firmware

1. Prepare the firmware file you wish to apply.
 - a) Visit the product web page from <http://www.aten.com/global/en/>
 - b) In the **Support and Download** tab, download a firmware file.
2. Log in the VP3520's web console, and then go to **System > Maintenance**.
3. In the Firmware Upgrade section, click **Browse File** to select the firmware file that you downloaded, and then click **Upgrade**. The upgrade starts immediately.
4. When the upgrade is complete, a confirmation message appears and the unit reboots.

Backing Up System Settings

You can back up and export the VP3520's configurations. This backup will not include the username and password settings.

1. Log in the VP3520's web console, and then go to **System > Maintenance**.
2. Click **Back Up**.

Restoring System Settings

1. Log in the VP3520's web console, and then go to **System > Maintenance**.
2. To restore the VP3520's settings, click **Browse File** to locate a previously backed up file (.aes), and then click **Restore**.

Resetting the Default Settings

1. Log in the VP3520's web console, and then go to **System > Maintenance**.
2. Click **Reset to Default**. This will reset all the settings, including network settings to default.

Network Settings

To configure the VP3520's network connection settings, log in the web console, and then go to **System > Network**.

Network

▼ IP setting

Mode

DHCP Manual

IP address

192.168.1.32

Mask

255.255.255.0

Gateway

192.168.1.1

▼ Browser

Timeout

30mins ▼

▼ IP installer

Mode

Enable ▼

Apply

IP Settings

- ◆ **Mode:** Configure the method to which the VP3520 obtains an IP address and connects to the network.
 - ◆ **DHCP:** Select this option for the connected network switch to dynamically assign an IP address, subnet mask, gateway, and DNS to the VP3520.
 - ◆ **Manual:** Select this option for the VP3520 to use a fixed IP address. Specify the IP address, subnet mask, and default gateway.

Browser

- ◆ **Timeout:** Sets the duration of time that a web browser waits to obtain connection to the VP3520 before terminating the request.

IP Installer

- ◆ **Mode:** Sets the VP3520 to be viewed and configured (IP address) by the IP Installer Utility.
 - ◆ **Enable:** Sets the VP3520 to be viewed and configured (IP address) by the IP Installer Utility.
 - ◆ **View Only:** Sets the VP3520 to be viewed only by the IP Installer Utility.
 - ◆ **Disable:** Sets the VP3520 to be not recognizable by the IP Installer Utility.

Configuration Settings

To configure the VP3520’s control method and its settings, log in the web console, and then go to **System > Configuration**. It is recommended to configure the control method on the VP3520 before using the function keys and auto display controls.

Control Configuration			
Device Name	Control Type	Channel	
Display A	CEC	HDBT Out	↗
Display B	CEC	HDMI Out	↗
RS232-Serial	RS232	RS232-Serial	↗
RS232-HDBT Out	RS232	RS232-HDBT Out	↗
IR-Serial	IR	IR-Serial	↗
IR-HDBT Out	IR	IR-HDBT Out	↗
PJ-Link 1	Ethernet	PJ-Link	↗
PJ-Link 2	Ethernet	PJ-Link	↗
Relay 1	Relay	Relay 1	↗
Relay 2	Relay	Relay 2	↗

Configuring Display A and Display B

You can rename the device name, and use the drop-down menu to select a delay interval for the HDMI and HDBT output transmission in seconds.

Device Settings

Device Name

Control Type
CEC

Channel
HDBT Out

Delay Interval(Seconds)
 ▼

Cancel
Save

Configuring RS-232 Serial and RS-232 HDBT Out

You can rename the device name, and use the drop-down menus to configure the baud rate, data bit, stop bit, and parity settings.

Device Settings

Device Name
RS232-Serial

Control Type
RS232

Channel
RS232-Serial

Connection Settings

Baud Rate
9600

Data Bit
8

Stop Bit
1

Parity
None

Advanced

Cancel Save

Click **Advanced** to bring out more settings.

Delay Interval(Seconds)
0

Keep Connection Alive

Type
ASCII

Command

Interval(1.0~60.0 Seconds)
5

Basic

Configuring IR Serial and IR HDBT Out

You can rename the device name, and use the drop-down menus to configure the repeat times settings.

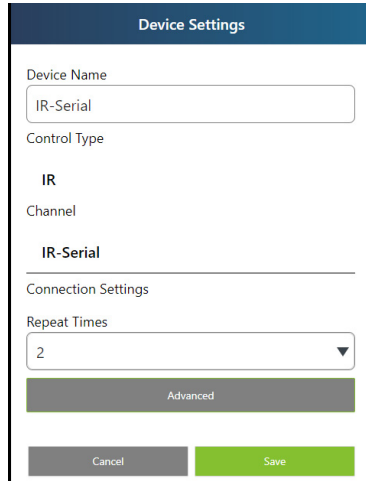

Device Settings

Device Name
IR-Serial

Control Type
IR

Channel
IR-Serial

Connection Settings

Repeat Times
2

Advanced

Cancel Save

Click **Advanced** to bring out more settings.

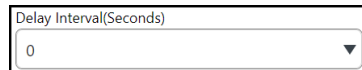

Delay Interval(Seconds)
0

Configuring PJ-Link

You can rename the device name, and use the drop-down menus to select a delay interval for the PJ-Link transmission in seconds. Remember to entered the correct IP address, port number, and password.

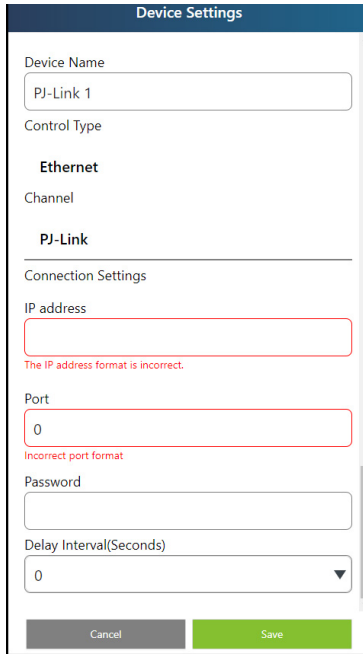

The screenshot shows the 'Device Settings' dialog box. The 'Device Name' field contains 'PJ-Link 1'. The 'Control Type' is set to 'Ethernet'. Under the 'Ethernet' section, the 'Channel' is set to 'PJ-Link'. The 'Connection Settings' section includes an 'IP address' field with a red border and a red error message below it: 'The IP address format is incorrect.' The 'Port' field also has a red border and a red error message: 'Incorrect port format'. The 'Password' field is empty. The 'Delay Interval(Seconds)' is set to '0' in a dropdown menu. At the bottom, there are 'Cancel' and 'Save' buttons.

Configuring Relay 1 and Relay 2

You can rename the device name, set a pulse time in seconds, and test the configuration.

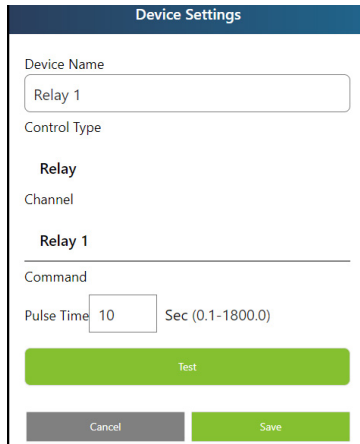

The screenshot shows the 'Device Settings' dialog box. The 'Device Name' field contains 'Relay 1'. The 'Control Type' is set to 'Relay'. Under the 'Relay' section, the 'Channel' is set to 'Relay 1'. The 'Command' section includes a 'Pulse Time' field with the value '10' and the unit 'Sec (0.1-1800.0)'. Below this is a green 'Test' button. At the bottom, there are 'Cancel' and 'Save' buttons.

Chapter 5

CLI Commands

Overview

The VP3520 can be configured and controlled via RS-232 or Telnet commands when connected to a host computer or other device, such as a control system. This chapter provides information on how to connect to the VP3520 via RS-232 / Telnet and command syntax.

Connecting to the VP3520 via Telnet

To establish a Telnet session with the VP3520, do the following:

1. Connect a host computer or control system to a shared network with the VP3520.
2. Open a command-line interpreter program from your computer.
3. In the command-line interpreter, type the VP3520's IP address in the following way:

```
telnet [IP address]:23
```

4. Press **Enter**. The login screen appears.
5. At the login prompt, type the login username and password for the VP3520.
6. When a session is established with the VP3520, you can control and configure the VP3520 via RS-232 commands. For more information on commands, see:
 - ♦ *Command Syntax*, page 59
 - ♦ *Command List*, page 60

Note: If a user logs in using a username that is already in session, the newest login takes effect and the previous session will be replaced.

Connecting to the VP3520 via RS-232

1. Connect a host computer or control system to the RS-232 serial port on the VP3520 unit.
2. Download and install controller software that supports RS-232 serial control and the operation system of your controller PC.
3. Execute the software and configure the connection settings to the following:
 - ◆ Serial line to connect to: **COM1**
 - ◆ Speed (baud): **19200**
 - ◆ Data bits: **8**
 - ◆ Stop bits: **1**
 - ◆ Parity: **None**
 - ◆ Flow control: **None**
4. When a session is established with the VP3520, you can control and configure the VP3520 via RS-232 commands. For more information on commands, see:
 - ◆ *Command Syntax*, page 59
 - ◆ *Command List*, page 60

Command Syntax

- ♦ The general form of a command is:

command parameter<argument> {one|two|three}

Notation	Description
command	The name of the command is shown in bold.
parameter	Indicates the name of the parameter.
<argument>	Indicates the name of the value or the information that the user must provide. Only type the information in the angle brackets, not the brackets themselves.
[]	Indicates optional items. Only type the information in the brackets, not the brackets themselves.
{ }	Indicates a set of choices from which the user must choose one.
	Indicates two or more mutually exclusive choices in a command line. Only type one of the choices in the command line, not the symbol.

- ♦ If you have two or more parameters, the order of these parameters among themselves does not affect the result of the operation. For example, both of the following commands execute the same task:

command name + parameter 1 + parameter 2

command name + parameter 2 + parameter 1

Command List

Use the following commands to control and configure the VP3520 via Telnet or RS-232. For details on establishing a Telnet or RS-232 session to the VP3520, see *Connecting to the VP3520 via Telnet*, page 57 and *Connecting to the VP3520 via RS-232*, page 58.

Port Numbers

Use the table below to find out the argument value for each input/output port on the VP3520. For example, the <input_port> value for video port 1 is i01, and the <input_port> value for audio input is i05.

Source		Source No.	Interface	Port Numbers
Video Input		1	HDBaseT	i01
		2	HDBaseT	i02
		3	HDMI	i03
		4	HDMI	i04
		5	HDMI	i05
Video Output		1	HDBaseT	o01
		2	HDMI	o02
Audio Input	AUDIO IN	N/A	Analog	i06
	MIC	N/A	Analog	i07
Audio Output	AUDIO OUT	N/A	Analog	o03
	LoZ OUT	N/A	Analog	o04
	COAXIAL	N/A	Digital	o05
HDBaseT Audio		1	HDBaseT	src01
HDMI Audio		2	HDMI	src02

Setting the Display Mode

- ◆ **Function**

Sets the VP3520 to matrix or mirror mode.

- ◆ **Syntax**

```
displaymode {matrix|mirror}
```

- ◆ **Parameters**

- ◆ **matrix**: When enabled, the AV sources can be configured separately, capable of showing different outputs.
- ◆ **mirror**: When enabled, display B uses the AV source assigned for display A and shows identical content.

- ◆ **Example**

```
displaymode matrix
```

Enabling or Disabling the Echo Function

- ◆ **Function**

Enables or disables the echo.

- ◆ **Syntax**

```
echo {on|off}
```

- ◆ **Parameters**

- ◆ **on**: Enables the echo.
- ◆ **off**: Disables the echo (default).

- ◆ **Example**

```
echo on
```

Setting the EDID Mode

◆ **Function**

Sets the VP3520's EDID mode.

◆ **Syntax**

```
edid {port1|remix|default}
```

◆ **Parameters**

- ◆ **port1**: Set the VP3520's EDID mode to follow the display connected to the output port A.
- ◆ **remix**: Set the VP3520's EDID mode to remix with which the system sends the optimum EDID of the connected displays to the sources.
- ◆ **default**: Set the VP3520's EDID mode to ATEN Default which sends ATEN-predefined EDID to the connected sources (default).

◆ **Example**

```
edid default
```

Configuring the Mute Function

◆ **Functions and Syntax**

Syntax	Function
mute	Indicates the mute setting for each input and output port.
mute {i<input_port> i sys i*}	Indicates the mute setting for the specified input or output port.
mute {o<output_port> o sys o*}	
mute {i<input_port> i*} {on off}	Mutes / unmutes the audio of a specified audio input or output.
mute {o<output_port> o*} {on off}	

◆ **Parameters**

- ◆ **i<input_port>**: Specifies an input port in two digits.
- ◆ **i sys**: Refers to all audio inputs (source devices, line-in, and mic).
- ◆ **i***: Refers to all input ports.
- ◆ **o<output_port>**: Specifies an output port in two digits.
- ◆ **o sys**: Refers to all audio outputs (display devices and speakers).
- ◆ **o***: Indicates all output ports.
- ◆ **on**: Mute the specified input / output ports.

- ◆ `off`: Unmute the specified input / output ports.
- ◆ **Example**

```
mute o01 off
```

Configuring the Read Status

◆ **Functions and Syntax**

Syntax	Function
<code>read</code>	Displays the video and audio input assigned to each output port, EDID mode, device information, and network settings.
<code>read version</code>	Displays the system firmware version.
<code>read o<output_port> connection</code>	Displays the video and audio input assignment to the specified output port.
<code>read o<output_port> connection video</code>	Displays the video input assignment to the specified output ports.
<code>read o<output_port> connection audio</code>	Displays the audio assignment to the specified output port.

◆ **Parameters**

- ◆ `version`: Indicates the system firmware version.
- ◆ `o<output_port>`: Specifies an output port in two digits.
- ◆ `connection`: Indicates both the video and audio input assignment.
- ◆ `video`: Indicates only the video input assignment.
- ◆ `audio`: Indicates only the audio input assignment.
- ◆ **Example**

```
read o01 connection video
```

Resetting the Unit

- ◆ **Function**
Resets the VP3520 to its default settings.
- ◆ **Syntax**
`reset`

Configuring the Scaling

◆ **Functions and Syntax**

Syntax	Function
<code>scaling</code>	Reads the scaler settings on output A and B.
<code>scaling o<output_port o*></code>	Configures the scaling setting for the specified output port.
<code>hor</code>	Configures the horizontal resolution for the specified output port.
<code>ver</code>	Configures the vertical resolution for the specified output port.
<code>freq</code>	Configures the frequency resolution for the specified output port.
<code>cs <rgb yuv420 yuv422></code>	Configures the color space for the specified output port.
<code>native</code>	Maps the display's resolution to the specified output port.

- ◆ **Parameters**
 - ◆ `o<output_port>`: Specifies an output port in two digits.
 - ◆ `o*`: Indicates all output ports.
 - ◆ `hor`: Sets the horizontal resolution.
 - ◆ `ver`: Sets the vertical resolution.
 - ◆ `freq`: Sets the frequency.
 - ◆ `cs`: Sets the color space.
 - ◆ `native`: Maps the display's native resolution (default).
- ◆ **Example**
`scaling o02 hor 1920 ver 1080 freq 60`

Enabling or Disabling the Standby Mode

◆ **Functions and Syntax**

Syntax	Function
<code>standby</code>	Displays the current standby mode setting. Standby mode is a power-saving mode that shuts parts of the system down to allow the user to quickly resume operation when needed.
<code>standby on off</code>	Enables or disables the standby mode.

◆ **Parameters**

- ◆ On: Enables the standby mode.
- ◆ Off: Disables the standby mode (default).

◆ **Example**

```
standby off
```

Switching Sources

◆ **Function**

Switches the specified source on the specified display.

◆ **Syntax**

```
sw {o<output_port>|o*} {i<input_port>|i+|i-}
```

◆ **Parameters**

- ◆ `i<input_port>`: Specifies an input port in two digits.
- ◆ `+`: Indicates the next input port.
- ◆ `-`: Indicates the previous input port.
- ◆ `o<output_port>`: Specifies an output port in two digits.
- ◆ `o*`: Indicates all output ports.

◆ **Examples**

```
sw o01 i02
```

```
sw o01 +
```

```
sw o* i02
```

Configuring the Switching Mode

◆ Function

Enables or disables auto switching.

◆ Syntax

```
swmode {auto|off}
```

◆ Parameters

- ◆ `auto`: Enables the auto switch (default).
- ◆ `off`: Disables the auto switch.

◆ Example

```
swmode auto
```

Configuring the Volume

◆ Functions and Syntax

Syntax	Function
<code>volume</code>	Indicates the total volume and the volume for each input and output port.
<code>volume {i<input_port> i*}</code> <code>v<volume_number></code>	Configures the volume of a specified input / output port.
<code>volume {o<output_port> o<sys> o*}</code> <code>v<volume_number></code>	

◆ Parameters

- ◆ `i<input_port>`: Specifies an input port in two digits.
- ◆ `i*`: Indicates all input ports.
- ◆ `o<output_port>`: Specifies an output port in two digits.
 - ◆ Output 1 (HDBaseT): `o01`
 - ◆ Output 2 (HDMI): `o02`
- ◆ `o*`: Indicates all output ports.
- ◆ `v<volume_number>`: Specifies the volume you wish to set to the specified audio port in two digits (01 - 10).

◆ Examples

```
volume i01 v10
```

```
volume o03 v05
```

Setting the Fan Speed

- ◆ **Function**

Sets the internal fan speed that cools the VP3520.

- ◆ **Syntax**

```
fan {low|mid|high}
```

- ◆ **Parameters**

- ◆ low: Sets the internal fan to low speed (default).
- ◆ mid: Sets the internal fan to normal speed.
- ◆ high: Sets the internal fan to high speed.

- ◆ **Examples**

```
fan low
```

Rebooting the Unit

- ◆ **Function**

Reboots the VP3520.

- ◆ **Syntax**

```
reboot
```

Configuring the Audio Mapping

◆ **Functions and Syntax**

Syntax	Function
<code>o {output_port}</code>	Specifies the output port.
<code>src {port}</code>	Specifies an audio source from display A or display B.
<code>type {sd}</code>	Sets the audio of the specified output port (analog) to follow a specified audio source (digital) between display A or display B.

◆ **Parameters**

- ◆ `o<output_port>`: Specifies an output port in two digits.
- ◆ `src<port>`: Specifies an audio source in two digits.
 - ◆ `src01`: Indicates display A.
 - ◆ `src02`: Indicates display B.
- ◆ `sd`: Sets the audio of the specified output port (analog) to follow a specified audio source (digital) between display A or display B.

◆ **Examples**

```
audiomap o03 src01 sd
```

Chapter 6

Video Presentation Control App

Overview

The ATEN Video Presentation Control App is designed to help you conveniently joining a meeting, share contents, switch sources and displays, and configure system settings to your VP3520 device.



Supported Systems

The ATEN Video Presentation Control App supports the following mobile operating systems:

Mobile Operating System	Supported Versions
Android	version 8.0 or later
iOS	version 12 or later

Installing and Configuring the App

1. Install the ATEN Video Presentation Control App on a mobile device.

- a) From the mobile device, tap the **App Store**  or **Google Play**  icon.
- b) In the search box, type “ATEN Video Presentation Control App”.
- c) Tap **ATEN Video Presentation Control App** and install the app.
Or,
- d) Scan the QR Code below to install the app.



2. From the mobile device, tap the **ATEN Video Presentation Control App** icon  .

Note: Make sure to connect the mobile device to the network where the VP3520 is installed.

iOS Version

Main Page

When logged in, the ATEN Video Presentation Control App defaults to the scanning page. Refer to the table below for an overview of the functions on each tab.

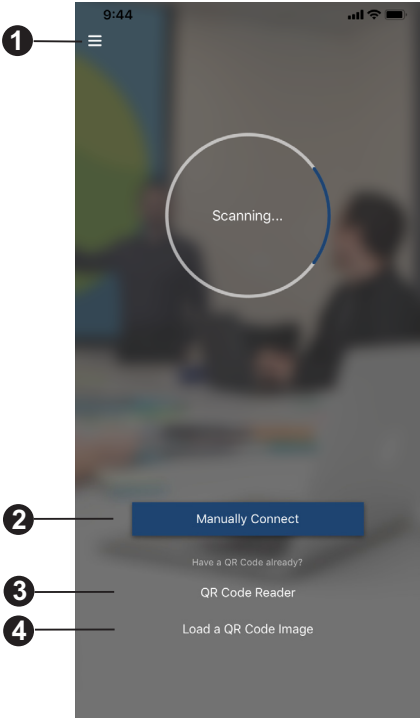

No.	Component	Description
1	Info 	Tap the info icon to show information such as version, privacy policy, and contact us.
2	Manually Connect	Tap this icon to manually connect to join a meeting by entering its IP address or a 4-digit room code.
3	QR Code Reader	Tap this icon to scan a QR code to join a meeting.
4	Load a QR Code Image	Tap this icon to upload a QR code image to join a meeting.

Info

Below screen is what the info page looks like. It shows the version, privacy policy and contact us. Tap on the **Contact Us** and it takes you straight to our ATEN's official website.



Note: Unless otherwise specified, all the screens shown in this manual are for smartphone only. The layout of the actual screens for tablet may vary slightly from these examples.

Joining a Meeting

There are three ways to join a meeting through our ATEN Video Presentation Control App on VP3520. When the App is opened, it automatically scans for the device and available rooms to access. Or you can manually type in the IP address and room code, or use a QR code to join a meeting. Each methods are described below.

Joining a Meeting Automatically

To automatically scan and join a meeting, follow the steps below.

1. Open the ATEN Video Presentation Control App and wait for the scanning process to finish.

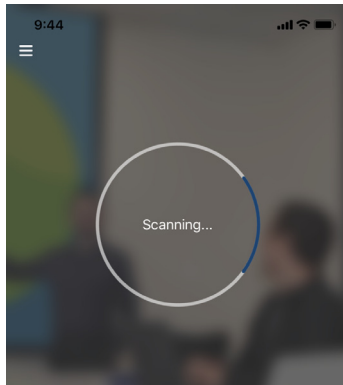

2. When the scanning finishes, the Room List appears. Tap on a room to join the meeting.

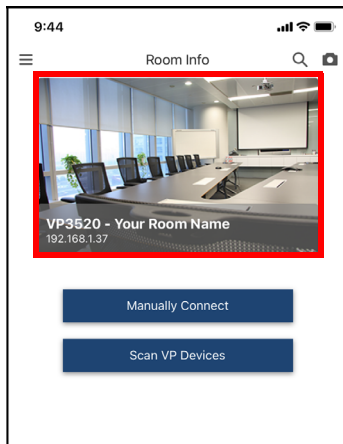

3. Enter the username and password, and then tap **Login**.

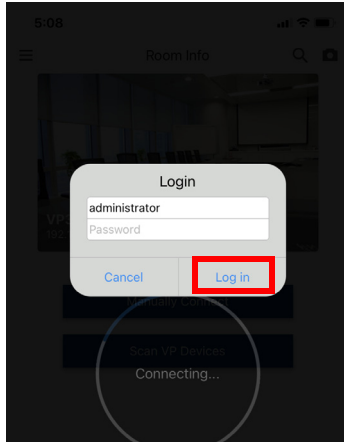

4. Now you have successfully joined the meeting.

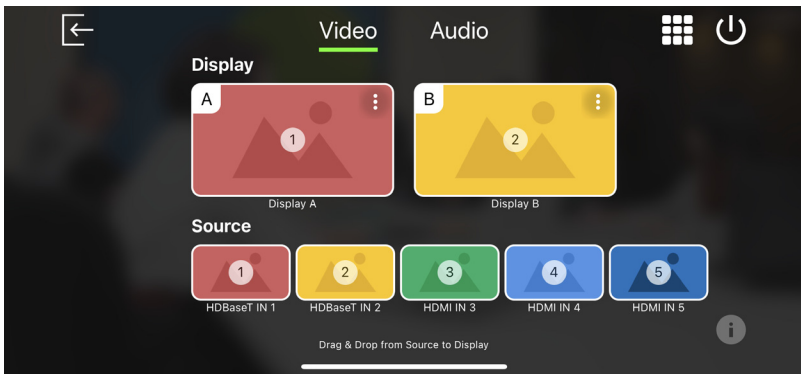

Joining a Meeting via Manually Connect

To manually connect and join a meeting, follow the steps below.

1. Open the ATEN Video Presentation Control App and tap **Manually Connect**.

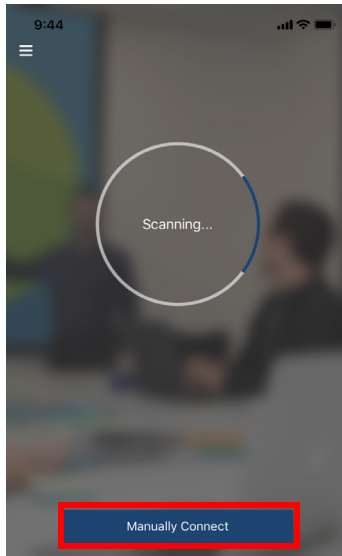

2. Type in the IP address of the VP3520, and then tap **Connect**.

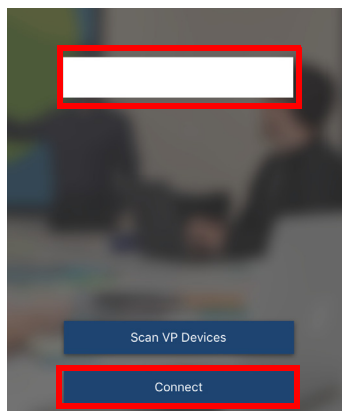

3. Enter the username and password, and then tap **Login**.

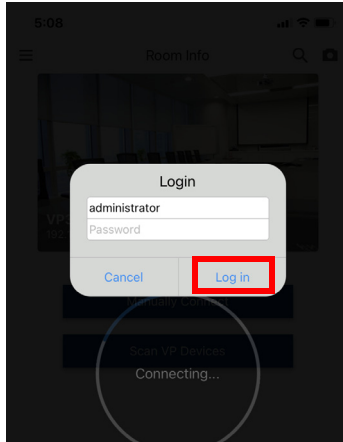

4. Now you have successfully joined the meeting.

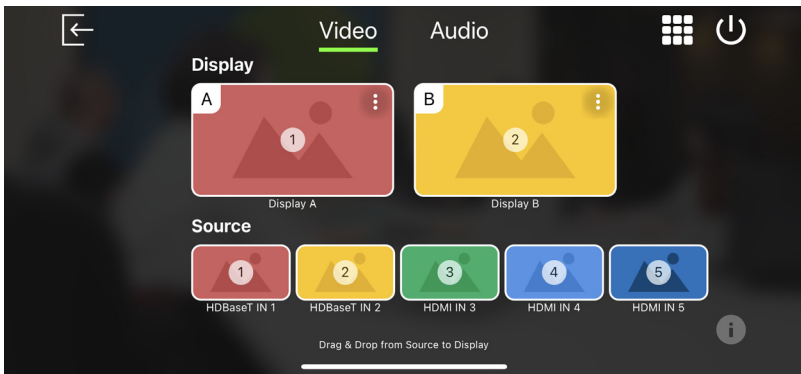

Joining a Meeting via QR Code

To join a meeting via QR code, follow the steps below.

1. Open the ATEN Video Presentation Control App and tap on the **QR Code Reader** or **Load a QR Code Image**.

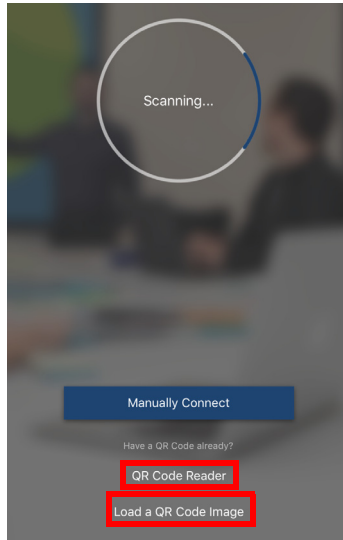

2. Tap on the **QR Code Reader** to scan a pre-generated QR code.
3. Tap on the **Load a QR Code Image** to upload a pre-generated QR code.
4. Now you have successfully joined the meeting.

Control Panel Smartphone

You can perform the following tasks with the control panel.

- ◆ Switch display sources
- ◆ Change the display mode, resolution, or aspect ratio settings
- ◆ Configure the VP3520's main system settings

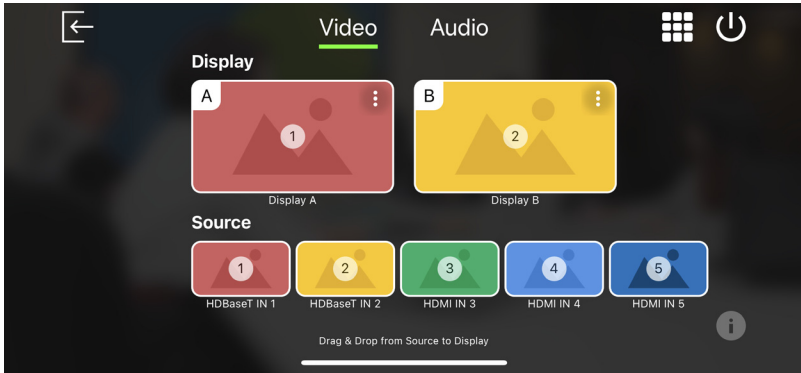

Function Key

To bring out the function keys table for easy control, simply tap the  from the main screen, and the function keys table below appears,

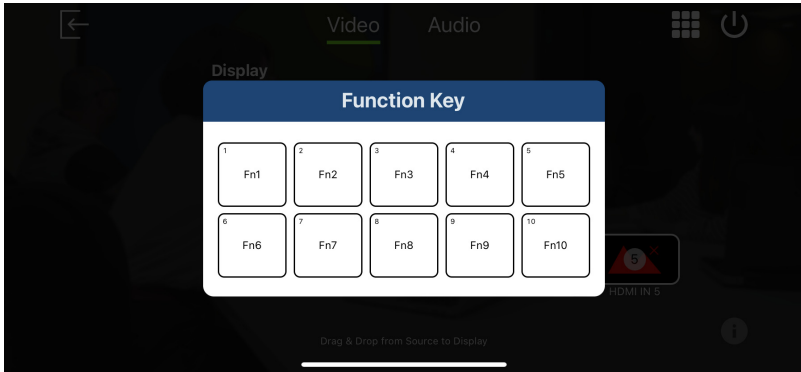

Enabling Standby Mode

To enable the standby mode, follow the steps below.

1. Press the  from your main screen.

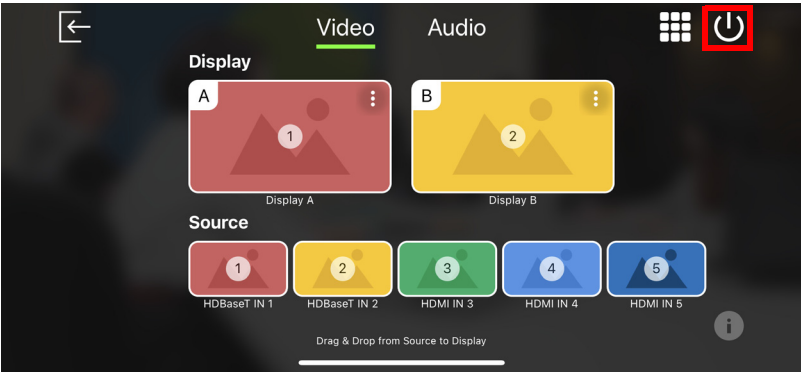

2. A warning screen appears. then tap **OK**.

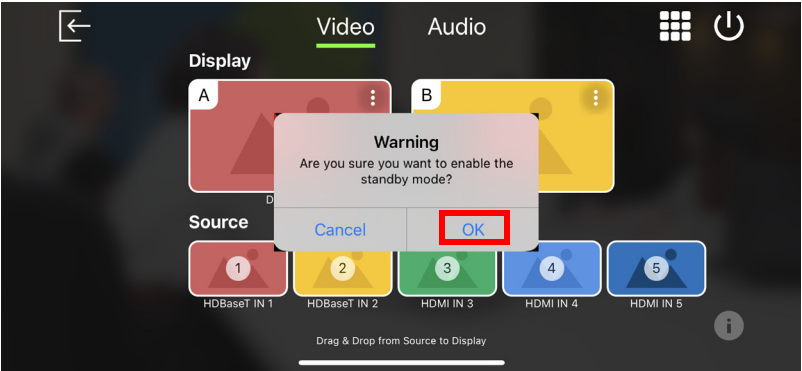

Disabling Standby Mode

To disable the standby mode, tap the  from the from your screen.

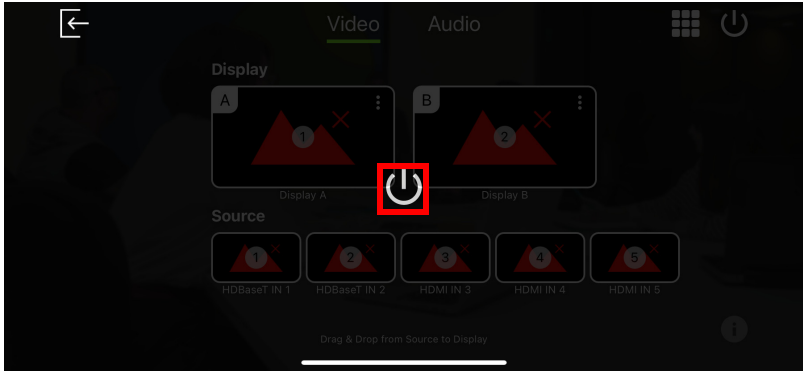

Checking the System Version

To check the system information, follow the steps below.

1. Press the  from your main screen.

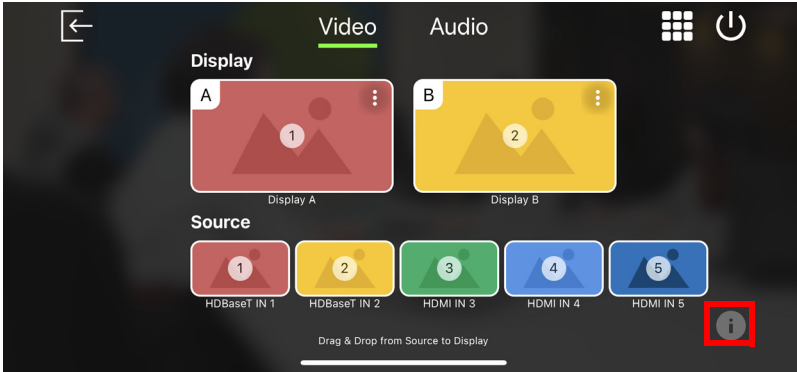

2. Below screen appears.

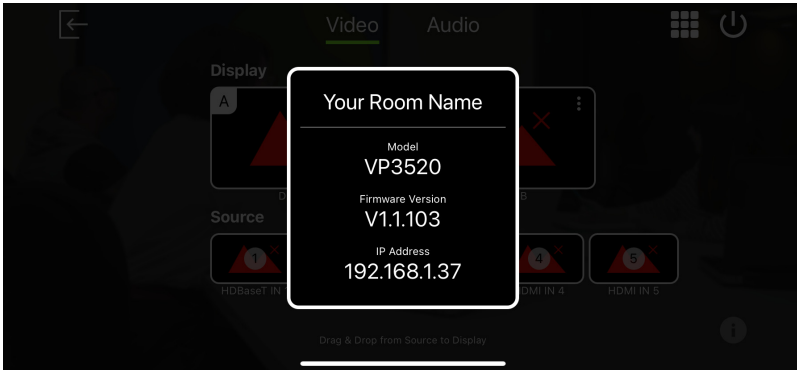

Video Panel

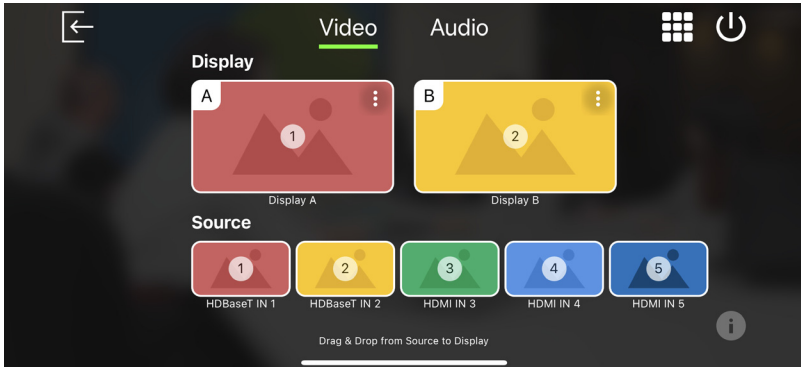

Switching a Source for a Display

To switch a source for a display, follow the steps below.

1. To switch HDBaseT in source to Display A. From the video panel, drag the source to Display A.

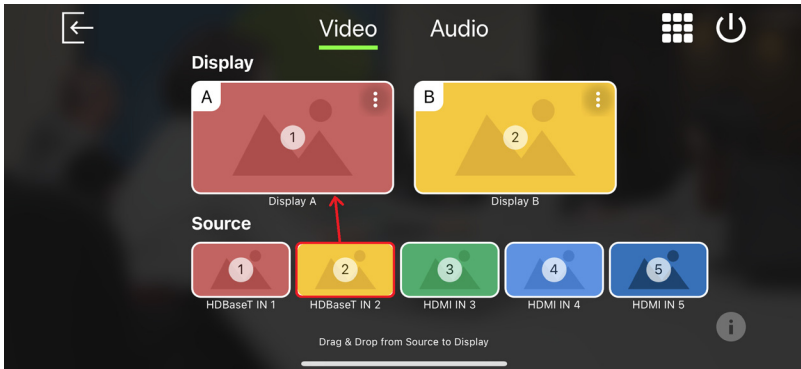

2. The Display A is now displaying content from HDBaseT In.

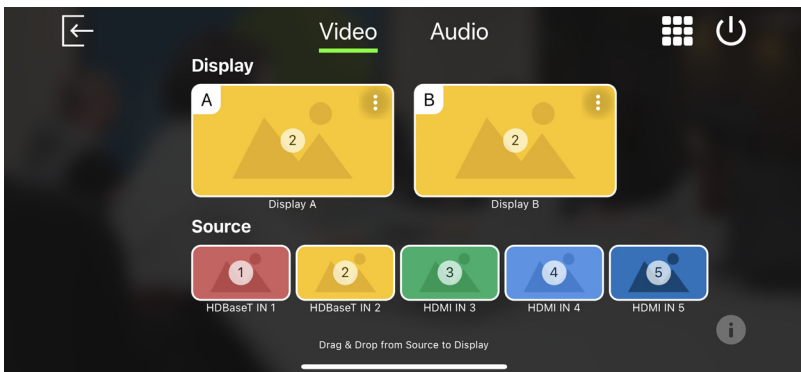

Display Features and Settings

To go live, enable multi-view layout, or configure display settings for the selected display, follow the steps below.

1. Tap  from the top right corner of the selected display.

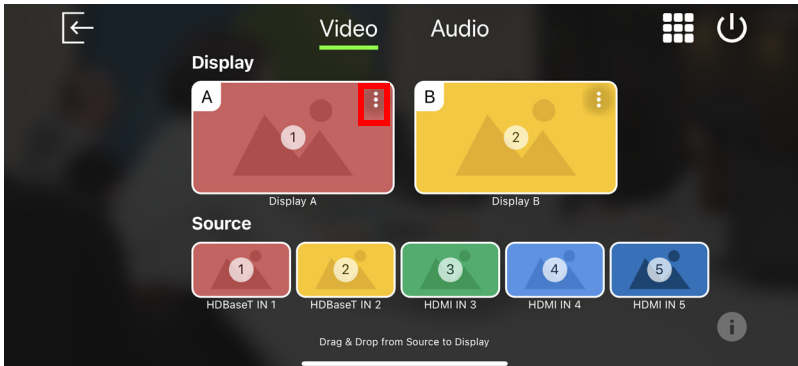

2. The below screen appears.

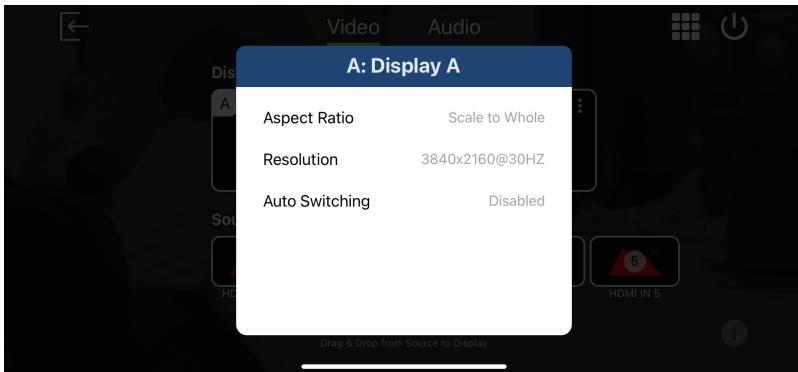



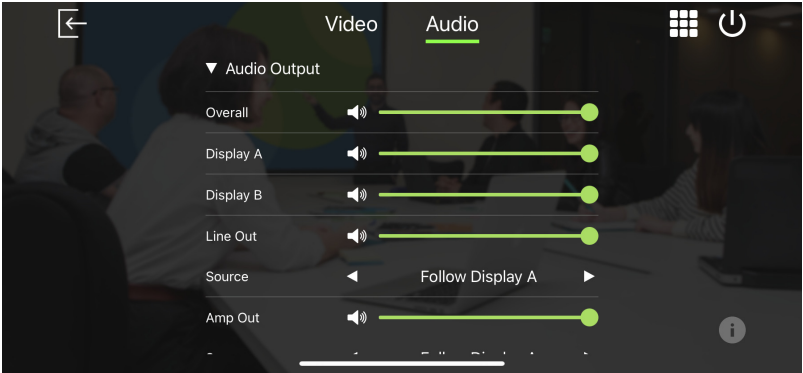

System Settings	Description
Note: Default settings are indicated in bold.	
Resolution	Selects a resolution and refresh rate setting for the display device. This field is only available when the display is connected to the VP3520.
Aspect Ratio	<ul style="list-style-type: none"> ◆ Scale: Fully extends the video to the four sides of the display. ◆ Auto fit: Proportionally scales the video to fit the display without cutting any content off. This may leave some blank on either the top and bottom or the left and right of the screen. ◆ Auto cut: Proportionally scales the video to fully fill the display. The content that goes out of the display range will be cut off.
Auto Switching	Disables / enables the auto switching for the display device.
Mirror Mode	Toggles the mirror mode on of off for display B. Each connected display mirrors each other and does not take different settings. Click the checkbox to enable, configuration on display A is automatically applied to the display B. Note: This setting is only available on display B.

Audio Panel





Audio Output Settings





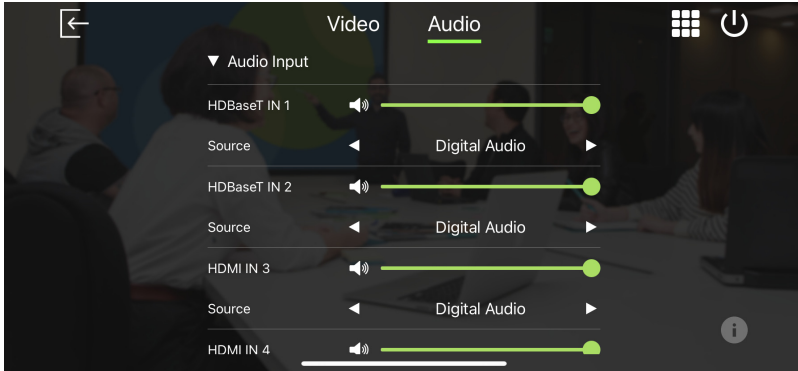

System Settings			Description
Note: Default settings are indicated in bold.			
Audio Output	Overall	<ul style="list-style-type: none"> ◆ Increase (+) ◆ Decrease (-) ◆ Mute 	Sets the volume of the speaker connected to VP3520 and tap  to mute or unmute.
	Display A	<ul style="list-style-type: none"> ◆ Increase (+) ◆ Decrease (-) ◆ Mute 	Sets the volume of the display A connected to the VP3520 and tap  to mute or unmute.
	Display B	<ul style="list-style-type: none"> ◆ Increase (+) ◆ Decrease (-) ◆ Mute 	Sets the volume of the display B connected to the VP3520 and tap  to mute or unmute.
	Line Out	<ul style="list-style-type: none"> ◆ Increase (+) ◆ Decrease (-) ◆ Mute 	Sets the volume of the independent speaker connected to the audio output ports on the VP3520 and tap  to mute or unmute.
	Source	<ul style="list-style-type: none"> ◆ Follow Display A ◆ Follow Display B ◆ Audio In 	Sets the audio source for the independent speaker connected to the audio output ports of the VP3520.
	Amp Out	<ul style="list-style-type: none"> ◆ Increase (+) ◆ Decrease (-) ◆ Mute 	Sets the volume of the independent speaker connected to the audio output ports on the VP3520 and tap  to mute or unmute.
	Source	<ul style="list-style-type: none"> ◆ Follow Display A ◆ Follow Display B ◆ Audio In 	Sets the audio source for the independent speaker connected to the audio output ports of the VP3520.

Audio Input Settings



System Settings			Description
Note: Default settings are indicated in bold.			
Audio Input	HDBaseT IN 1	<ul style="list-style-type: none"> ◆ Increase (+) ◆ Decrease (-) ◆ Mute 	Sets the volume of the HDBaseT source connected to the VP3520 and tap  to mute or unmute.
	Source	<ul style="list-style-type: none"> ◆ Digital Audio ◆ Embedded Audio In 	<p>Sets the audio source for the HDBaseT source connected to the VP3520.</p> <p>To use the audio source that comes along with the video, select Digital Audio. To use the audio source from the independent audio source (connected to the Audio In port), select Embedded Audio In.</p>
	HDBaseT IN 2	<ul style="list-style-type: none"> ◆ Increase (+) ◆ Decrease (-) ◆ Mute 	Sets the volume of the HDBaseT source connected to the VP3520 and tap  to mute or unmute.

System Settings		Description
Note: Default settings are indicated in bold.		
Source	<ul style="list-style-type: none"> ◆ Digital Audio ◆ Embedded Audio In 	<p>Sets the audio source for the HDBaseT source connected to the VP3520.</p> <p>To use the audio source that comes along with the video, select Digital Audio. To use the audio source from the independent audio source (connected to the Audio In port), select Embedded Audio In.</p>
HDMI IN 3	<ul style="list-style-type: none"> ◆ Increase (+) ◆ Decrease (-) ◆ Mute 	<p>Sets the volume of the HDMI 3 source connected to the VP3520 and tap  to mute or unmute.</p>
Source	<ul style="list-style-type: none"> ◆ Digital Audio ◆ Embedded Audio In 	<p>Sets the audio source for the HDMI 3 source connected to the VP3520.</p> <p>To use the audio source that comes along with the video, select Digital Audio. To use the audio source from the independent audio source (connected to the Audio In port), select Embedded Audio In.</p>
HDMI IN 4	<ul style="list-style-type: none"> ◆ Increase (+) ◆ Decrease (-) ◆ Mute 	<p>Sets the volume of the HDMI 4 source connected to the VP3520 and tap  to mute or unmute.</p>
Source	<ul style="list-style-type: none"> ◆ Digital Audio ◆ Embedded Audio In 	<p>Sets the audio source for the HDMI 4 source connected to the VP3520.</p> <p>To use the audio source that comes along with the video, select Digital Audio. To use the audio source from the independent audio source (connected to the Audio In port), select Embedded Audio In.</p>

System Settings		Description
Note: Default settings are indicated in bold.		
HDMI IN 5	<ul style="list-style-type: none"> ◆ Increase (+) ◆ Decrease (-) ◆ Mute 	Sets the volume of the HDMI 5 source connected to the VP3520 and tap  to mute or unmute.
Source	<ul style="list-style-type: none"> ◆ Digital Audio ◆ Embedded Audio In 	<p>Sets the audio source for the HDMI 5 source connected to the VP3520.</p> <p>To use the audio source that comes along with the video, select Digital Audio. To use the audio source from the independent audio source (connected to the Audio In port), select Embedded Audio In.</p>
AUDIO In	<ul style="list-style-type: none"> ◆ Increase (+) ◆ Decrease (-) ◆ Mute 	Sets the volume of the independent audio source connected to the audio input port on the VP3520 and tap  to mute or unmute.
MIC	<ul style="list-style-type: none"> ◆ Increase (+) ◆ Decrease (-) ◆ Mute 	Sets the volume of the microphone connected to the MIC input ports on VP3520 and tap  to mute or unmute.
Gain	<ul style="list-style-type: none"> ◆ +20dB ◆ +30dB ◆ +40dB ◆ +50dB 	Sets the MIC gain of the microphone connected to the VP3520.

Safety Instructions

General

- ◆ This product is for indoor use only.
- ◆ Read all of these instructions. Save them for future reference.
- ◆ Follow all warnings and instructions marked on the device.
- ◆ Do not place the device on any unstable surface (cart, stand, table, etc.). If the device falls, serious damage will result.
- ◆ Do not use the device near water.
- ◆ Do not place the device near, or over, radiators or heat registers.
- ◆ The device cabinet is provided with slots and openings to allow for adequate ventilation. To ensure reliable operation, and to protect against overheating, these openings must never be blocked or covered.
- ◆ The device should never be placed on a soft surface (bed, sofa, rug, etc.) as this will block its ventilation openings. Likewise, the device should not be placed in a built in enclosure unless adequate ventilation has been provided.
- ◆ Never spill liquid of any kind on the device.
- ◆ Unplug the device from the wall outlet before cleaning. Do not use liquid or aerosol cleaners. Use a damp cloth for cleaning.
- ◆ The device should be operated from the type of power source indicated on the marking label. If you are not sure of the type of power available, consult your dealer or local power company.
- ◆ To prevent damage to your installation it is important that all devices are properly grounded.
- ◆ Do not allow anything to rest on the power cord or cables. Route the power cord and cables so that they cannot be stepped on or tripped over.
- ◆ Position system cables and power cables carefully; Be sure that nothing rests on any cables.
- ◆ Never push objects of any kind into or through cabinet slots. They may touch dangerous voltage points or short out parts resulting in a risk of fire or electrical shock.

- ◆ Do not attempt to service the device yourself. Refer all servicing to qualified service personnel.
- ◆ If the following conditions occur, unplug the device from the wall outlet and bring it to qualified service personnel for repair.
 - ◆ The power cord or plug has become damaged or frayed.
 - ◆ Liquid has been spilled into the device.
 - ◆ The device has been exposed to rain or water.
 - ◆ The device has been dropped, or the cabinet has been damaged.
 - ◆ The device exhibits a distinct change in performance, indicating a need for service.
 - ◆ The device does not operate normally when the operating instructions are followed.
- ◆ Only adjust those controls that are covered in the operating instructions. Improper adjustment of other controls may result in damage that will require extensive work by a qualified technician to repair.

Rack Mounting

- ◆ Before working on the rack, make sure that the stabilizers are secured to the rack, extended to the floor, and that the full weight of the rack rests on the floor. Install front and side stabilizers on a single rack or front stabilizers for joined multiple racks before working on the rack.
- ◆ Always load the rack from the bottom up, and load the heaviest item in the rack first.
- ◆ Make sure that the rack is level and stable before extending a device from the rack.
- ◆ Use caution when pressing the device rail release latches and sliding a device into or out of a rack; the slide rails can pinch your fingers.
- ◆ Do not overload the AC supply branch circuit that provides power to the rack. The total rack load should not exceed 80 percent of the branch circuit rating.
- ◆ Make sure that all equipment used on the rack – including power strips and other electrical connectors – is properly grounded.
- ◆ Ensure that proper airflow is provided to devices in the rack.
- ◆ Ensure that the operating ambient temperature of the rack environment does not exceed the maximum ambient temperature specified for the equipment by the manufacturer.
- ◆ Do not step on or stand on any device when servicing other devices in a rack.

Technical Support

International

- ◆ For online technical support – including troubleshooting, documentation, and software updates: <http://support.aten.com>
- ◆ For telephone support, call this number:

International	886-2-8692-6959
China	86-400-810-0-810
Japan	81-3-5615-5811
Korea	82-2-467-6789
North America	1-888-999-ATEN ext 4988 1-949-428-1111

North America

Email Support		support@aten-usa.com
Online Technical Support	Troubleshooting Documentation Software Updates	http://www.aten-usa.com/support
Telephone Support		1-888-999-ATEN ext 4988

When you contact us, please have the following information ready beforehand:

- ◆ Product model number, serial number, and date of purchase
- ◆ Your computer configuration, including operating system, revision level, expansion cards, and software
- ◆ Any error messages displayed at the time the error occurred
- ◆ The sequence of operations that led up to the error
- ◆ Any other information you feel may be of help

Specifications

Video Input	
Interfaces	3 x HDMI Type-A female (Black) 2 x HDBaseT (RJ-45) female (Silver) with PoH
Max. Distance	<p>HDMI:</p> <ul style="list-style-type: none"> ◆ 4K@60Hz (4:4:4) up to 5 m ◆ 4K@30Hz up to 10 m ◆ 1080p@60Hz up to 15 m <p>HDBaseT:</p> <ul style="list-style-type: none"> ◆ 4K@30Hz (4:4:4) up to 35 m (Cat 5e / 6) ◆ 4K@30Hz (4:4:4) up to 40 m (Cat 6a or ATEN 2L-2910 Cat 6) ◆ 1080p @60Hz up to 60 m (Cat 5e / 6) ◆ 1080p @60Hz up to 70 m (Cat 6a or ATEN 2L-2910 Cat 6)
Video Output	
Interfaces	1 x HDMI Type-A female (Black) 1 x HDBaseT (RJ-45) female (Silver) with PoH
Max. Distance	<p>HDMI:</p> <ul style="list-style-type: none"> ◆ 4K@60Hz (4:4:4) up to 5 m ◆ 4K@30Hz up to 10 m ◆ 1080p@60Hz up to 15 m <p>HDBaseT:</p> <ul style="list-style-type: none"> ◆ 4K@30Hz up to 35 m (Cat 5e / 6) ◆ 4K@30Hz up to 40 m (Cat 6a or ATEN 2L-2910 Cat 6) ◆ 1080p @60Hz up to 60 m (Cat 5e / 6) ◆ 1080p @60Hz up to 70 m (Cat 6a or ATEN 2L-2910 Cat 6)
Video	
Max. Resolution	<p>HDMI: Up to 4096 x 2160 / 3840 x 2160 @ 60Hz (4:4:4)</p> <p>HDBaseT:</p> <ul style="list-style-type: none"> ◆ Up to 4096 x 2160 / 3840 x 2160 @60Hz (4:2:0) ◆ Up to 4096 x 2160 / 3840 x 2160 @30Hz (4:4:4)
Compliance	HDMI; 4K HDR HDCP 2.2 compatible; Consumer Electronics Control (CEC)
Audio	

Output	Line out (Unbalanced): 1 x captive screw connector, 3-pole Digital Audio: 1 x coaxial Amplifier Out: 1 x captive screw connector, 4-pole, stereo out 10 watts per channel, 4 ohms, 1 kHz, 0.1% THD
Input	Stereo Audio (HDMI / HDBT): 1 X mini stereo jack female (Green) Microphone: 1 x captive screw connector, 3-pole (with selectable phantom power)
Control	
RS-232	1 x DB-9 female (Black); controlling and configuring the VP device 1 x captive screw connector, 3-pole; controlling the connected AC device
IR	1 x mini stereo jack female (Black); controlling the VP device 1 x captive screw connector, 2-pole; controlling the connected AC device
Ethernet	1 x RJ-45 female (Silver); supports PJ-Link protocol
Interfaces	
Relay	2 x captive screw connector, 2-pole
Switches	
Power	1 x pushbutton (LED: Green / Orange) 1 x slide switch (+48 phantom power)
Video Input Port Selection	5 x pushbuttons (LED: Green)
Video Output Port Selection	2 x pushbuttons (LED: Orange)
Selection	Mic: 1 x knob Volume: 1 x knob Mode / Unlock: 1 x pushbutton Function Key: 4 x pushbuttons
EDID Settings	EDID Mode: ATEN Default / Display A / Remix
Connectors	
Power	1 x 3-prong AC socket
Power Consumption	AC110V:46.7W:314BTU Note: If PoH (max. 10W each port) and Amplifier out (max. 20W) are used on the VP3520, the maximum power consumption for AC110V will be 98.2W. AC220V:45.8W:310BTU Note: If PoH (max. 10W each port) and Amplifier out (max. 20W) are used on the VP3520, the maximum power consumption for AC220V will be 97.5W.

Environmental	
Operating Temperature	0 - 40°C
Storage Temperature	-20 - 60°C
Humidity	0 x 80% RH, Non-Condensing
Physical Properties	
Housing	Metal
Weight	3.80 kg (8.37 lb)
Dimensions (L x W x H)	43.24 x 27.23 x 4.40 cm (17.02 x 10.72 x 1.73 in)
Input Resolutions	
	Video DCC
	640 X 480 @ 60 Hz
	640 X 480 @ 67 Hz
	640 X 480 @ 72 Hz
	640 X 480 @ 75 Hz
	720 X 400 @ 70 Hz
	800 x 600 @ 56 Hz
	800 x 600 @ 60 Hz
	800 x 600 @ 72 Hz
	800 x 600 @ 75 Hz
	1024 x 768 @ 60 Hz
	1024 x 768 @ 70 Hz
	1024 x 768 @ 75 Hz
	1280 x 800 @ 60 Hz
	1280 x 1024 @ 60 Hz
	1280 x 1024 @ 75 Hz
	1400 x 1050 @ 60 Hz
	1440 x 900 @ 60 Hz
	1600 x 1200 @ 60 Hz
	1680 x 1050 @ 60 Hz
	1920 x 1080 @ 60 Hz
	1920 x 1200 @ 60 Hz

1920 x 1200 @ 60 Hz (reduced blanking)
1080p @ 60 Hz
480p @ 60 Hz (4:3)
480p @ 60 Hz (16:9)
720p @ 60 Hz
1080i @ 60 Hz
640 x 480 @ 60 Hz (4:3)
576p @ 50 Hz (4:3)
576p @ 50 Hz (16:9)
720p @ 50 Hz
1080i @ 50 Hz
1080p @ 50 Hz
1080p @ 24 Hz
1080p @ 25 Hz
1080p @ 30 Hz
1080p @ 120 Hz
1080p @ 240 Hz
3840 x 2160p @ 24 Hz
3840 x 2160p @ 25 Hz
3840 x 2160p @ 30 Hz
3840 x 2160p @ 50 Hz
3840 x 2160p @ 60 Hz
4096 x 2160 p @ 24 Hz
4096 x 2160 p @ 25 Hz
4096 x 2160 p @ 30 Hz
4096 x 2160 p @ 50 Hz
4096 x 2160 p @ 60 Hz
3840 x 2160p @ 50 Hz (4:2:0)
3840 x 2160p @ 60 Hz (4:2:0)
4096 x 2160p @ 50 Hz (4:2:0)
4096 x 2160p @ 60 Hz (4:2:0)

Limited Warranty

ATEN warrants its hardware in the country of purchase against flaws in materials and workmanship for a Warranty Period of two [2] years (warranty period may vary in certain regions/countries) commencing on the date of original purchase. This warranty period includes the [LCD panel of ATEN LCD KVM switches](#). Select products are warranted for an additional year (see [A+ Warranty](#) for further details). Cables and accessories are not covered by the Standard Warranty.

What is covered by the Limited Hardware Warranty

ATEN will provide a repair service, without charge, during the Warranty Period. If a product is defective, ATEN will, at its discretion, have the option to (1) repair said product with new or repaired components, or (2) replace the entire product with an identical product or with a similar product which fulfills the same function as the defective product. Replaced products assume the warranty of the original product for the remaining period or a period of 90 days, whichever is longer. When the products or components are replaced, the replacing articles shall become customer property and the replaced articles shall become the property of ATEN.

To learn more about our warranty policies, please visit our website: <http://www.aten.com/global/en/legal/policies/warranty-policy/>

© Copyright 2022 ATEN® International Co., Ltd.
Released: 2022-08-19

ATEN and the ATEN logo are registered trademarks of ATEN International Co., Ltd. All rights reserved. All other brand names and trademarks are the registered property of their respective owners.