



Simply Better Connections

VP2020 / VP2021

4K Wireless Presentation Switch /
4K Wireless Presentation Switch with
Quad View
User Manual

Compliance Statements

FEDERAL COMMUNICATIONS COMMISSION INTERFERENCE STATEMENT

This equipment has been tested and found to comply with the limits for a Class B digital service, pursuant to Part 15 of the FCC rules. These limits are designed to provide reasonable protection against harmful interference in a residential installation. Any changes or modifications made to this equipment may void the user's authority to operate this equipment. This equipment generates, uses, and can radiate radio frequency energy. If not installed and used in accordance with the instructions, may cause harmful interference to radio communications. However, there is no guarantee that interference will not occur in a particular installation. If this equipment does cause harmful interference to radio or television reception, which can be determined by turning the equipment off and on, the user is encouraged to try to correct the interference by one or more of the following measures:

- ◆ Reorient or relocate the receiving antenna.
- ◆ Increase the separation between the equipment and receiver.
- ◆ Connect the equipment into an outlet on a circuit different from that to which the receiver is connected.
- ◆ Consult the dealer or an experienced radio/TV technician for help.

The device complies with Part 15 of the FCC Rules. Operation is subject to the following two conditions: (1) this device may not cause harmful interference, and (2) this device must accept any interference received, including interference that may cause undesired operation.

Frequency band(s) in which the radio equipment operates & maximum radio-frequency power

2412MHz~2472MHz:17.93dBm

5180MHz~5320MHz:15.67dBm

This equipment should be installed and operated with a minimum distance of 20 cm between the radiator and your body.

Dieses Gerät sollte mit einem Mindestabstand von 20 cm zwischen dem Kühler und Ihrem Körper installiert und betrieben werden.

The device is restricted to indoor use only when operating in the 5150 to 5350 MHz frequency range in AT, BE, BG, CY, CZ, DE, DK, EE, EL, ES, FI, FR, HR, HU, IE, IT, LT, LU, LV, MT, NL, PL, PT, RO, SE, SI, SK, UK(NI), CH, IS, LI, NO, TR.

You are cautioned that changes or modifications not expressly approved by the part responsible for compliance could void the user's authority to operate the equipment.

FCC RF Radiation Exposure Statement:

1. This Transmitter must not be co-located or operating in conjunction with any other antenna or transmitter.
2. This equipment complies with FCC RF radiation exposure limits set forth for an uncontrolled environment. This equipment should be installed and operated with a minimum distance of 20 centimeters between the radiator and your body.

FCC Caution

Any changes or modifications not expressly approved by the party responsible for compliance could void the user's authority to operate this equipment.

Suggestion

Shielded twisted pair (STP) cables must be used with the unit to ensure compliance with FCC & CE standards.



KCC Statement

유선 제품용 / B 급 기기 (가정용 방송 통신 기기)
 이 기기는 가정용 (B 급) 전자파적합기기로서 주로 가정에서 사용하는
 것을 목적으로 하며, 모든 지역에서 사용할 수 있습니다.

Industry Canada Statement

This Class B digital apparatus complies with Canadian ICES-003.

CAN ICES-003 (B) / NMB-003 (B)

HDMI Trademark Statement

The terms HDMI, HDMI High-Definition Multimedia Interface, and the HDMI Logo are trademarks or registered trademarks of HDMI Licensing Administrator, Inc.



RoHS

This product is RoHS compliant.

User Information

Online Registration

Be sure to register your product at our online support center:

International	http://eservice.aten.com
---------------	---

Telephone Support

For telephone support, call this number:

International	886-2-8692-6959
China	86-400-810-0-810
Japan	81-3-5615-5811
Korea	82-2-467-6789
North America	1-888-999-ATEN ext 4988 1-949-428-1111

User Notice

All information, documentation, and specifications contained in this manual are subject to change without prior notification by the manufacturer. The manufacturer makes no representations or warranties, either expressed or implied, with respect to the contents hereof and specifically disclaims any warranties as to merchantability or fitness for any particular purpose. Any of the manufacturer's software described in this manual is sold or licensed *as is*. Should the programs prove defective following their purchase, the buyer (and not the manufacturer, its distributor, or its dealer), assumes the entire cost of all necessary servicing, repair and any incidental or consequential damages resulting from any defect in the software.

The manufacturer of this system is not responsible for any radio and/or TV interference caused by unauthorized modifications to this device. It is the responsibility of the user to correct such interference.

The manufacturer is not responsible for any damage incurred in the operation of this system if the correct operational voltage setting was not selected prior to operation. PLEASE VERIFY THAT THE VOLTAGE SETTING IS CORRECT BEFORE USE.

Product Information

For information about all ATEN products and how they can help you connect without limits, visit ATEN on the Web or contact an ATEN Authorized Reseller. Visit ATEN on the Web for a list of locations and telephone numbers:

International	http://www.aten.com
North America	http://www.aten-usa.com

Package Contents

Check to make sure that all the components are in working order. If you encounter any problem, please contact your dealer.

- ◆ 1 VP2020 4K Wireless Presentation Switch / VP2021 4K Wireless Presentation Switch with Quad View
- ◆ 1 power adapter and power cord
- ◆ 2 WiFi antennas
- ◆ 1 user instructions

Table of Contents

Compliance Statements	ii
User Information	iv
Online Registration	iv
Telephone Support	iv
User Notice	iv
Product Information	v
Package Contents	vi
Table of Contents	vii
About this Manual	x
Conventions	xi

1. Introduction

Overview	1
Features	2
Planning the Installation	4
Required Equipment	4
Optional Equipment	4

2. Hardware Setup

Hardware Overview	5
VP2020 / VP2021 Front View	5
VP2020 / VP2021 Rear View	5
Installation	7

3. Local Operation

Overview	9
Power LED Indication	9
Resetting the Unit	10
Displaying the Room Info	11
More Settings	12
Display Settings and Behavior	14
Auto Display Layout	14
The OSD	16
OSD Tool Menu	17
Getting Screen Captures / Crops	18
Screen Capturing	18
Cropping	19
Whiteboard	21
Pencil Options	23
Highlighter Options	23
Eraser Options	23
Save As	24
Whiteboard Layouts	24

Removing a Whiteboard Layer	24
Background Pad	25
Pencil Options	26
Highlighter Options	26
Eraser Options	27
Save As	27

4. Remote Operation

Overview	29
Default Network and Login Settings	29
Supported Web Browsers	30
Operation Consideration	30
Browser Sharing	31
Joining a Meeting as Participant via Web Console	31
Logging In the Web Console	34
The Web Console Main Screen	37
General Settings	38
Basic Settings	38
Resolution Settings	40
Date & Time Settings	41
Network Settings	42
Wi-Fi Settings	42
Ethernet Settings	44
Administration Settings	45
Update Settings	45
Password & Configuration Settings	46
Power Settings	48
Windows & macOS App Sharing	49
Joining a Meeting as Participant via App	49
The App Main Screen	51
Selecting Screen or Tab	53
Remote View	53
More App Settings	54
Joining a Meeting as Participant via Quick Join	56
Joining a Meeting as Participant via Install-Free Version	57
iOS Screen Sharing via AirPlay	59

5. Wireless Presentation App

Overview	61
Operation Consideration	61
Installing and Configuring the App	61
Android Version	64
Main Page	64
Selecting Screen or Tab	66
Remote View	66
More App Settings	67

Appendix

Safety Instructions	69
General	69
Rack Mounting	71
Technical Support	72
International	72
North America	72
Specifications	73
VP2020	73
VP2021	74
ATEN Standard Warranty Policy	76

About this Manual

This user manual is provided to help you get the most from the 4K Wireless Presentation Switch and Remote Pad. It covers all aspects of installation, configuration, and operation for the VP2020 / VP2021.

Chapter 1, *Introduction* introduces you to the VP2020 / VP2021. Its purpose, features, benefits, and installation considerations are described.

Chapter 2, *Hardware Setup* introduces the panel components of the 4K Wireless Presentation Switch and the IR Remote Control, and details the steps to quickly and safely install the VP2020 / VP2021.

Chapter 3, *Local Operation* provides information on how to locally operate and access the system settings via the panel pushbuttons and IR remote control.

Chapter 4, *Remote Operation* provides details on remote management and control tasks via the system web interface.

Chapter 5, *Wireless Presentation App* provides details on remotely configuring system settings via the ATEN Video Presentation Control App.

Appendix provides a list of safety instructions and precautions, contact information for ATEN technical support, product specifications, and other technical information.

Note:

- ◆ Read this manual thoroughly and follow the installation and operation procedures carefully to prevent any damage to the unit or any connected devices.
 - ◆ The product may be updated, with features and functions added, improved, or removed since the release of this manual. For an up-to-date user manual, visit <http://www.aten.com/global/en/>
-

Conventions

This manual uses the following conventions:

- `Monospaced` Indicates text that you should key in.
- [] Indicates keys you should press. For example, [Enter] means to press the **Enter** key. If keys need to be chorded, they appear together in the same bracket with a plus sign between them: [Ctrl+Alt].
 - 1. Numbered lists represent procedures with sequential steps.
 - ◆ Bullet lists provide information, but do not involve sequential steps.
 - > Indicates selecting the option (on a menu or dialog box, for example), that comes next. For example, Start > Run means to open the *Start* menu, and then select *Run*.
 -  Indicates critical information.

This Page Intentionally Left Blank

Chapter 1

Introduction

Overview

As a wireless BYOD solution, the VP2020 / VP2021 is a 4K presentation switch featuring a Wi-Fi module and multiple access approaches for the essential connectivity that a successful meeting requires. It enables users to cast up to 4K content to 1 HDMI-enabled display and 1 VGA-enabled display at the same time via Wi-Fi from their laptops or mobile devices. Such wireless connectivity supports all major operating platforms, including Windows, macOS, and Android, through the dedicated ATEN Wireless Presentation Switch App. Moreover, the VP2020 / VP2021 is compatible with AirPlay¹ and Google Cast¹, and Chrome.

The VP2020 / VP2021 contains various features that make it a perfect collaboration terminal. The VP2020 allows up to 8 attendees to quickly enter a meeting either wirelessly or via Ethernet connection to the local network; the VP2021, on the other hand, while enabling up to 8 attendees to join the meeting remotely, it also enables up to 20 to attend via Ethernet connection. With the capability of displaying multiple sources simultaneously, content can be presented in full screen / side-by-side / quad view (VP2021 only) screen layouts. When auto layout projection is enabled, the layout can be switched automatically whenever a new signal is detected. The USB-C and USB Type-A ports feature touch back functionality, delivering seamless operation of a presentation directly from a connected touchscreen or mouse. Moderation Mode gives the moderator access to manage and control attendees' connection status as well as the AV content being displayed. Moreover, the VP2021 supports collaboration tools, such as annotation, whiteboard on screen, and screen capturing, to take video conferencing and digital learning experiences to the next level.

Additional highlights include the all-metal enclosure that gives the presentation switch a sleek look while guaranteeing durability. VP2020 / VP2021's support for Power over Ethernet (PoE) connectivity makes installation easier without the need for an extra power adapter. Integration with audio amplifiers or mixing systems is made easier thanks to the audio de-embedding functionality. The VP2020 / VP2021 is a perfect fit for achieving seamless teamwork in any wireless meeting.

Features

- ◆ A BYOD presentation switch with wireless presentation capability
- ◆ Up to 4K content can be output to 1 HDMI-enabled display and 1 VGA-enabled display at the same time
- ◆ Allows native content sharing from users' laptop screens through the ATEN Wireless Presentation Switch App available on Windows, macOS, and Android
- ◆ Compatible with popular operating systems, including AirPlay¹, Google Cast¹, and Chrome, for wireless content sharing
- ◆ Multi-view presentation:
 - ◆ VP2020 — up to two sources can be shared wirelessly in full screen / side-by-side layout
 - ◆ VP2021 — up to four sources can be shared wirelessly in full screen / side-by-side / quad view layout
- ◆ Auto layout projection — presentation layout can be switched automatically whenever a new signal is detected
- ◆ Multiple simultaneous connections:
 - ◆ VP2020 allows for up to 8 attendees to join a meeting
 - ◆ VP2021 allows for up to 8 attendees to join a meeting wirelessly and up to 20 through Ethernet connection to the local network
- ◆ Moderation Mode — the moderator can manage and control attendees' connection status and the AV content being displayed
- ◆ Multiple collaboration tools² — annotation, whiteboard on screen, and screen capturing
- ◆ USB touch back — allows for seamless operation of a presentation directly from a connected touchscreen or mouse
- ◆ Web GUI for control and configuration of the presentation switch
- ◆ Supports Power over Ethernet (PoE) connectivity for easier installation, eliminating the need for an additional power adapter
- ◆ HDMI audio de-embedding — enables easy integration with audio amplifiers or mixing systems
- ◆ A perfect collaboration terminal that suits any wireless video conference and digital learning application

Note: 1. The information contained is the property of ATEN International Co. LTD or their respective owners. All rights reserved. AirPlay® is a trademark of Apple Inc., registered in the U.S. and other countries and regions. Google Cast™ is a trademark of Google LLC. Any other

brand names or marks are used for compatibility description only and are trademarks or registered trademarks of their respective owners.

2. These collaboration tools are supported by VP2021 only.
-

Planning the Installation

Required Equipment

Prepare the following equipment before installing the VP2020 / VP2021.

- ◆ Up to 2 display devices, one equipped with an HDMI port and the other equipped with a VGA port

Optional Equipment

Prepare the following equipment as required.

- ◆ 1 active speaker
- ◆ 1 USB mouse
- ◆ 1 Ethernet cable to connect the VP2020 / VP2021 to a PoE-supported network switch for remote management via the web console, Wifi coverage, and power supply
- ◆ Mounting kits:
 - ◆ Rack mount kit

Chapter 2

Hardware Setup



1. Please review the safety information regarding the placement of this device in *Safety Instructions*, page 69.
2. Do not power on the VP2020 / VP2021 until all the necessary hardware is connected.

Hardware Overview

VP2020 / VP2021 Front View

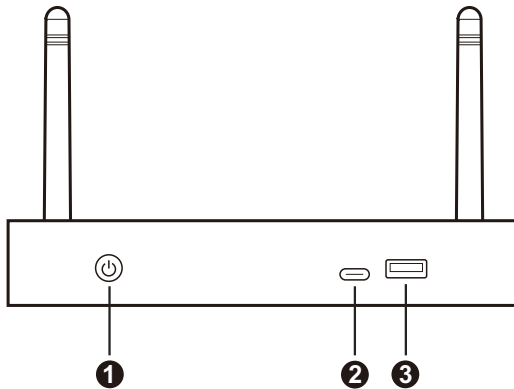

VP2020 / VP2021 Rear View

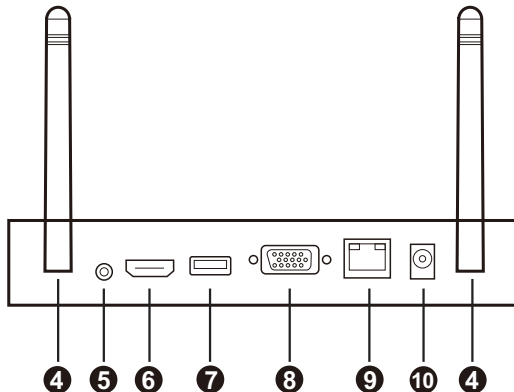

No.	Component	Description
1	power pushbutton / LED	Used to power on / off the VP2020 / VP2021, or enable/disable the standby mode. For details, see <i>Power LED Indication</i> , page 9.
2	USB-C port	Connects to a USB mouse or a USB-enabled touchscreen.
3	USB 3.0 Type-A port	Connects to a USB mouse or a USB-enabled touchscreen.
4	WiFi antenna ports	Connects to the supplied WiFi antennas.
5	audio output port	Connects to a set of active speakers.
6	HDMI output port	Connects to an HDMI-enabled display device.
7	USB 2.0 Type-A port	Connects to a USB mouse or a USB-enabled touchscreen.
8	VGA output port	Connects to a VGA display device.
9	Ethernet port	<ul style="list-style-type: none">◆ Connects to a network switch via an Ethernet cable to allow remote operation via the web console and to provide WiFi coverage.◆ Connects to a PoE-supported network switch via an Ethernet cable to allow remote operation via the web console, provide WiFi coverage, and power supply.
10	power jack	Receives a power adapter to supply power to the VP2020 / VP2021.

Installation

Follow the steps below to safely install sources, displays, and other equipment to the VP2020 / VP2021.

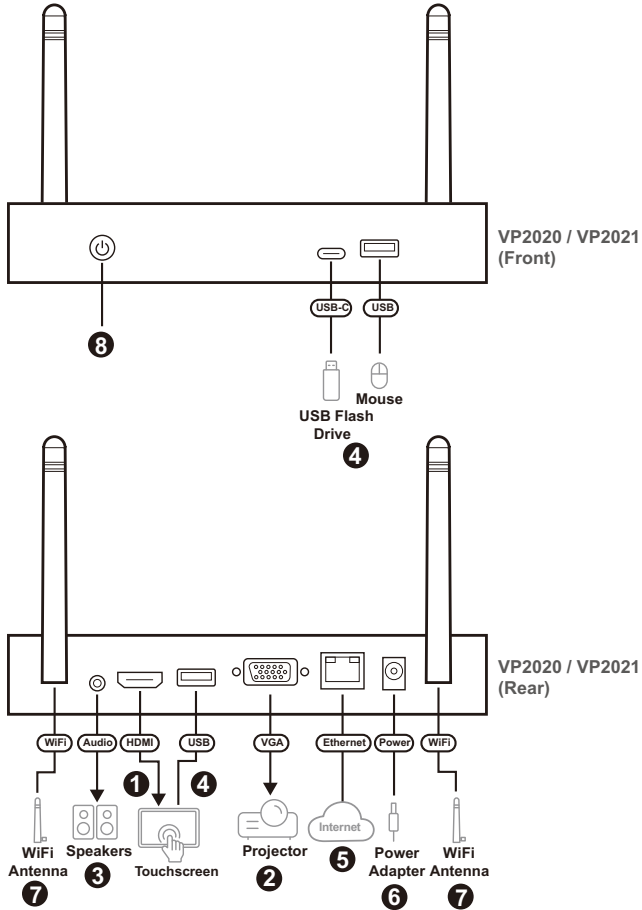

1. Connect an HDMI-enabled display to the unit's HDMI output port.
2. Connect a VGA projector to the unit's VGA output port.
3. (Optional) Connect a set of speakers to the unit's audio output port.

Note: If the VGA output port is used, connect a set of speakers for audio output.

4. (Optional)

- ◆ To operate the unit via OSD (on-screen display), connect a USB mouse to the unit's USB 2.0 Type-A, USB 3.0 Type-A, or USB-C ports.
 - ◆ To use a USB-enabled touchscreen, connect the USB-enabled touchscreen to the unit's USB 2.0 Type-A, USB 3.0 Type-A, or USB-C and HDMI output ports.
 - ◆ To use a USB flash drive for storage purposes, connect the USB flash drive to the unit's USB 2.0 Type-A, USB 3.0 Type-A, or USB-C ports.
5. To allow access to the web interface and to provide WiFi coverage for the meeting members, connect an Ethernet cable to the unit's Ethernet port. Optionally, connect the unit to a PoE-supported network switch for web interface accessibility, WiFi coverage, and power supply.

Note: If this Ethernet port is not connected with an Internet-enabled network switch via an Ethernet cable, then the unit does not provide Internet accessibility wirelessly. For mobile devices that can still use their cellular data while connected to the unit (without Internet accessibility) wirelessly, it is a benefit feature that the mobile operating system company provides. Please refer to its official website and related user manual for more information.

6. (Optional) Connect the power adapter to the unit's power jack.
7. Install the WiFi antennas to the unit's WiFi antenna ports.
8. Power on the unit by pressing the power pushbutton, and the power LED lights blue.
9. Download the ATEN Wireless Presentation App to join a meeting, share contents, switch displays, and configure system settings to the unit.
- a) For Android device, please refer to *Wireless Presentation App*, page 61.
 - b) For Windows and Mac PCs, please refer to *Remote Operation*, page 29.

Chapter 3

Local Operation

Overview

This chapter provides detailed information on the features of the VP2020 / VP2021's OSD (on-screen display), and how the power LED indicates the power status of the VP2020 / VP2021. You can perform the following tasks through the OSD (on-screen display):

- ◆ Make screen captures (VP2021 only)
- ◆ Use whiteboard to communicate with meeting participants in real-time (VP2021 only)
- ◆ Make notes on the video content (VP2021 only)

Power LED Indication

The power pushbutton is equipped with an LED that indicates the power status of the VP2020 / VP2021. Refer to the table below for the status and supported tasks for each LED indication.

LED Indication (Power Pushbutton)	VP2020 / VP2021 Status	Tasks
Flashes red	The VP2020 / VP2021 is loading system information.	Wait for the unit to finish loading information.
Red	The VP2020 / VP2021 is in standby mode.	The standby mode is a power-saving mode that shuts parts of the system down to allow the user to quickly resume operation when needed. To awake the VP2020 / VP2021, press the power pushbutton (VP2020 / VP2021 front panel) once.
Flashes blue	The VP2020 / VP2021 is busy running remote control processes.	Wait for the unit to finish running remote control processes.

LED Indication (Power Pushbutton)	VP2020 / VP2021 Status	Tasks
Blue	The VP2020 / VP2021 is awaken.	<ul style="list-style-type: none">◆ To enable the standby mode to conserve power, press the power pushbutton (VP2020 / VP2021 front panel) once.◆ To power off the unit:<ol style="list-style-type: none">(1) Press and hold the power pushbutton for 3 seconds. A confirmation message appears in the OSD.(2) Press the power pushbutton once. The VP2020 / VP2021 powers off.

Resetting the Unit

To perform a hardware reset on the VP2020 / VP2021, follow the steps below.

1. Power on the VP2020 / VP2021 by connecting the unit to a power supply.
2. Press the power pushbutton for 10 seconds.
3. Wait for the VP2020 / VP2021 to restart, the power LED lights blue to indicate the VP2020 / VP2021 is ready to operate.

Displaying the Room Info

To display meeting information such as login code, IP address for the web console, and QR code for the ATEN Wireless Presentation App to join the meeting, connect a HDMI-enabled and/or a VGA monitor to the VP2020 / VP2021's HDMI and VGA output port(s). The room info is automatically displayed on the OSD.

Note:

For more information on how to connect the VP2020 / VP2021 to your Android device or PC, see the cross references below.

- ◆ For Android device, please refer to *Wireless Presentation App*, page 61.
- ◆ For Windows and Mac PCs, please refer to *Remote Operation*, page 29.

The screenshot displays the ATEN OSD interface. On the left, a dark blue sidebar contains the ATEN logo, device name (VP2021-060a), device IP (192.168.1.206), and login code (1127). The main area is titled "How to join the meeting?" and contains two numbered steps:

- 1 Connect to the Network**: Accompanied by Wi-Fi and network icons.
- 2 Start sharing your screen wirelessly**: This step provides three options:
 - Download the APP "ATEN Wireless Presentation"**: Shows download links for Windows/macOS and Android, with a QR code for the Android app.
 - Use Web Browser to join (For Windows)**: Shows a search box for "Device IP" and lists supported browsers: Google Chrome and Microsoft Edge.
 - Use AirPlay or Google Cast**: Accompanied by AirPlay and Google Cast icons.

At the bottom of the sidebar, there is a "Ver. 1.0.25" label.

More Settings

In the advanced settings you can enable / disable Touch Back, Remote View (VP2021 only), and Moderation Mode. For this settings to become available, connect a USB mouse or a touch screen to the VP2020 / VP2021's USB 2.0 Type-A, USB 3.0 Type-A, or USB-C ports.

1. From the OSD main page, click the More Settings icon.

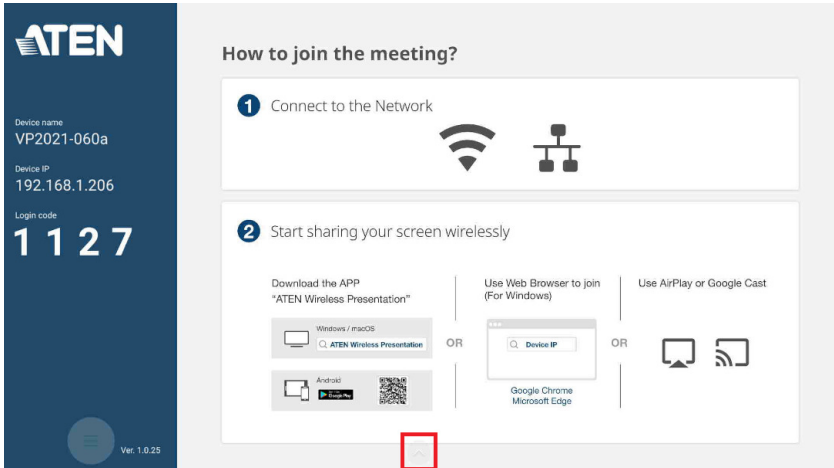

2. The More Settings menu appears.

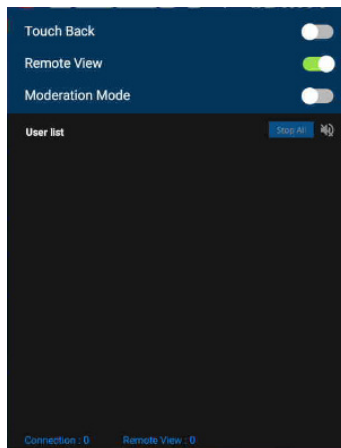

3. Please refer to the table below for the functions and its description.

Tool	Task
Touch Back	<p>Click to enable / disable the remote control on a streamed-in source. For example, if you wish to control a PPT from another person's sharing content, enable the Touch Back function.</p> <p>Note: When the Touch Back function is enabled, users are only allowed to remote control the PC's sharing screen that is shared through app, see <i>Windows & macOS App Sharing</i>, page 49.</p>
Remote View	<p>Click to enable / disable the Remote View. To bring the sharing content onto your mobile and laptop / PC screen for a clear view if you are far away from the main monitor, enable the Remote View function.</p> <p>Note: This function is only supported by VP2021.</p>
Moderation Mode	<p>Click to enable / disable the Moderation Mode. To allow the administrator to manage the participant's video and audio sharing request, enable the Moderation Mode.</p>

Display Settings and Behavior

The VP2020 / VP2021 supports multiple display layout from single, PbP, triple (VP2021 only), and quad (VP2021 only) for the streamed-in sources.

Auto Display Layout

The VP2020 / VP2021 supports auto display layout, the shared sources are displayed in predefined locations based on the order in which the source is shared. As sources are received by the VP2020 / VP2021, they appear on the display from left to right, top to bottom.

Single Display Layout

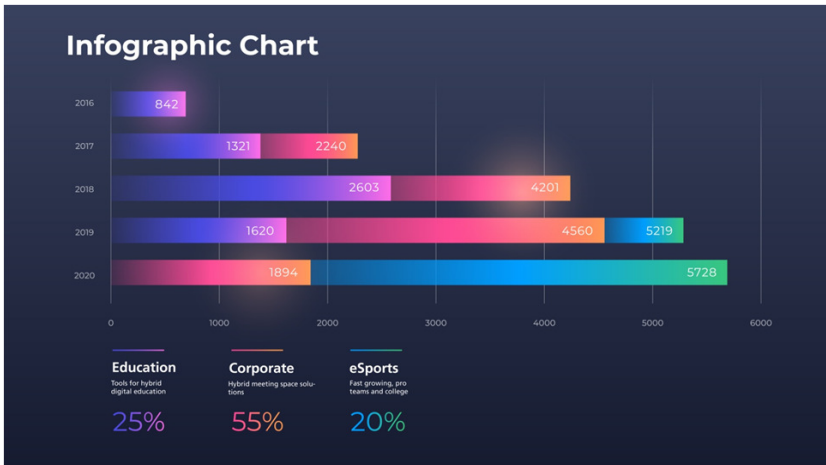

PbP Display Layout

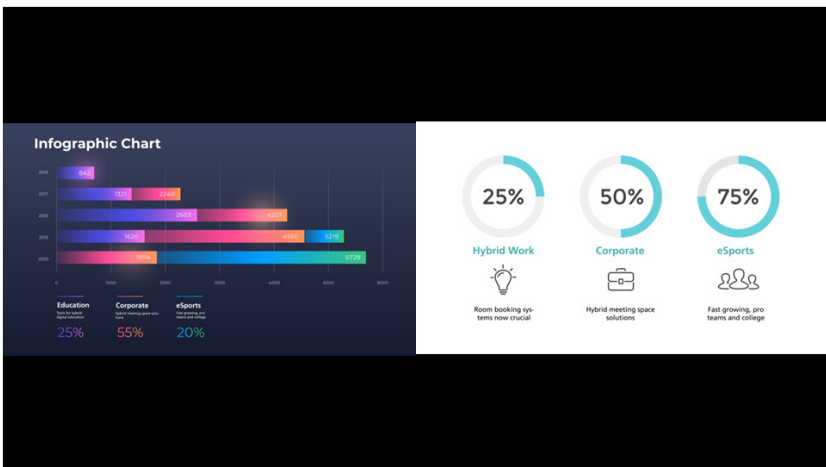

Triple Display Layout (VP2021 only)

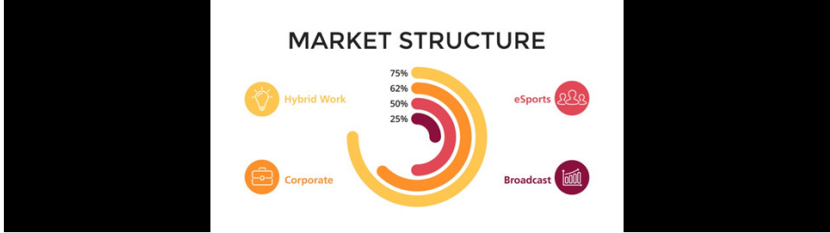
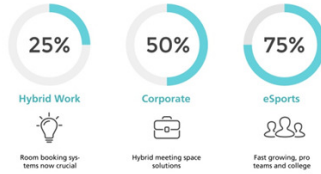
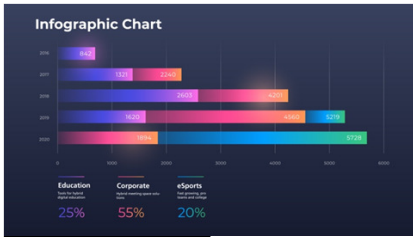

Quad Display Layout (VP2021 only)

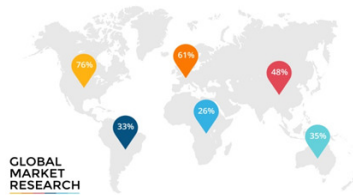
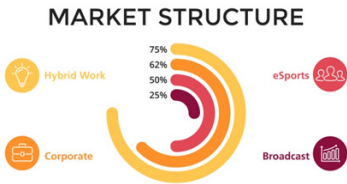
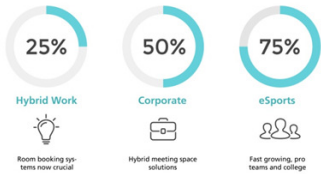

The OSD

To make a screen capture, use whiteboard, or make notes on a video content, connect a USB mouse or a touch screen to the VP2021's USB 2.0 Type-A, USB 3.0 Type-A, or USB-C ports for OSD operation.

Note: These functions are only supported by VP2021.

1. From the OSD main page, click on the Tool icon.

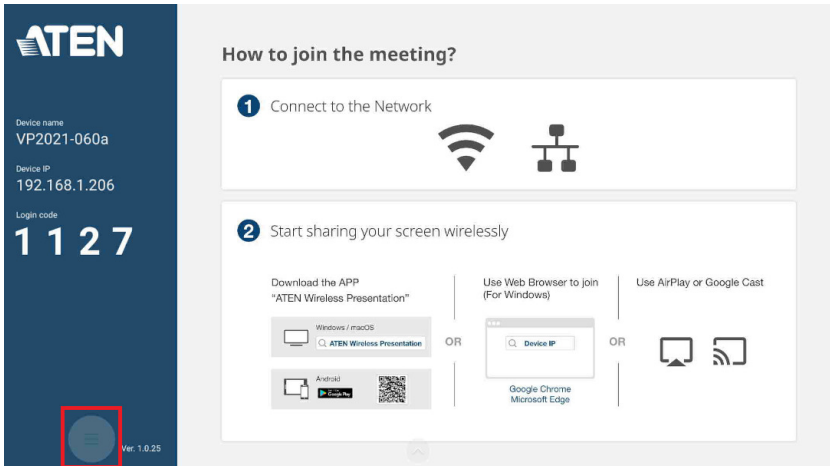

2. The Tool menu appears.

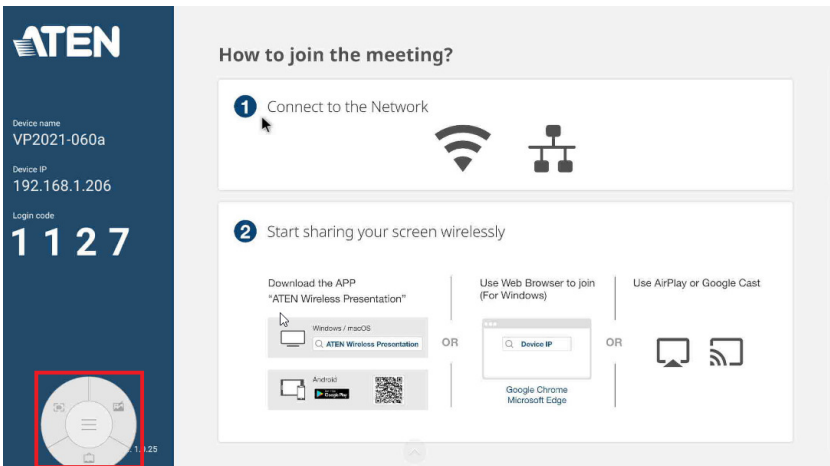

OSD Tool Menu

The following controls are available in the tool menu. For the OSD tool menu to become available, connect a USB mouse or a touch screen to the VP2021's USB 2.0 Type-A, USB 3.0 Type-A, or USB-C ports.

Note: These functions are only supported by VP2021.

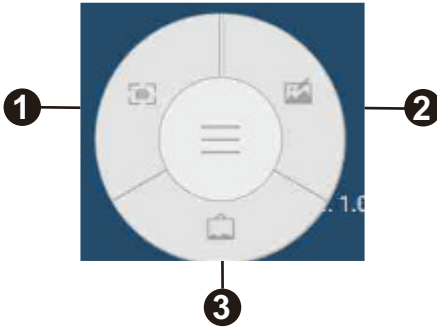

No.	Tool	Task
1	Screen Capture	Click this icon to capture / crop the video content and save it to your device or a USB storage device connected to the VP2021. Make sure you have a storage device inserted to the VP2021 for this function to be available. For more information, see <i>Getting Screen Captures / Crops</i> , page 18.
2	Whiteboard	Click this icon to bring up the whiteboard. For more information, see <i>Whiteboard</i> , page 21.
2	Background Pad	Click this icon to make notes on the video content. For more information, see <i>Background Pad</i> , page 25.

Getting Screen Captures / Crops

You can capture or crop and save important screens during a meeting using the Screen Capture and Crop functions. To make a capture or crop the video content and save it to your device or a USB storage device connected to the VP2021, click  from the OSD tool menu. The screen below appears, please refer to the screen and table below for the supported functions and its description.

Note: This function is only supported by VP2021.

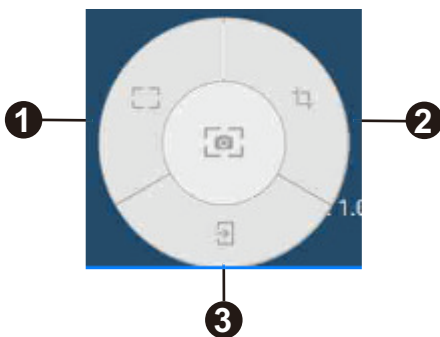

No.	Tool	Task
1	Screen Capture	Click this icon to screen capture the video content.
2	Crop	Click this icon to crop an area of the video content your wish to capture.
2	Go Back	Click this icon to go back to the previous page.

Screen Capturing

To make a screen capture, follow the steps below.

1. From the screen capture and crop page, click .
2. You are asked for a Save Option. You can save the captured content to image or PDF format, USB flash drive or your own device, or you can paste it into whiteboard for discussion.

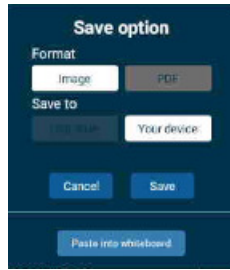

3. If you choose to save the screen capture to **Your device**, the VP2021 will automatically generate a QR code on the bottom right of the screen. Scan the QR code to open the saved file.

Cropping

To make a crop, follow the steps below.

Note: This function is only supported by VP2021.

1. From the screen capture and crop page, click .
2. From the screen, click, hold, and drag the arrow to locate the area of the video content you wish to crop.

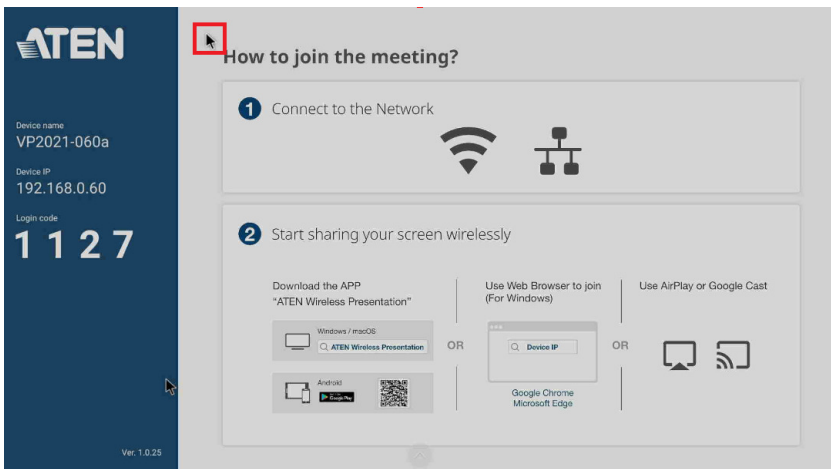

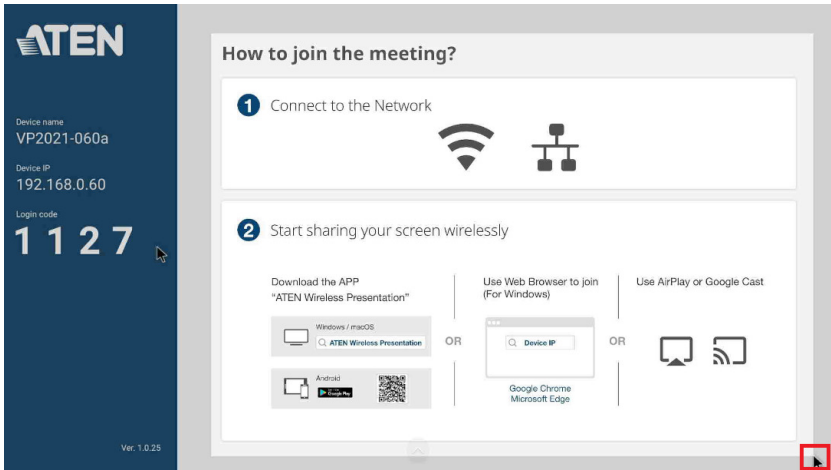

3. You are asked for a Save Option after the cropping is done. You can save the cropped content to image or PDF format, USB flash drive or your own device, or you can paste it into whiteboard for discussion.

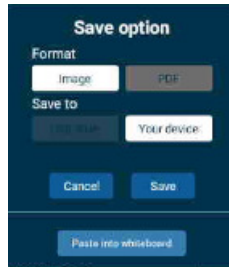

4. If you choose to save the cropped content to **Your device**, the VP2021 will automatically generate a QR code on the bottom right of the screen. Scan the QR code to open the saved file.

Whiteboard

The whiteboard allows you to draw, paste captured or cropped images, and share to all the participants. You can also save the whiteboard locally for future use. To use the whiteboard, click  from the OSD tool menu. The screen below appears, please refer to the screen and table below for the supported functions and its description.

Note: This function is only supported by VP2021.

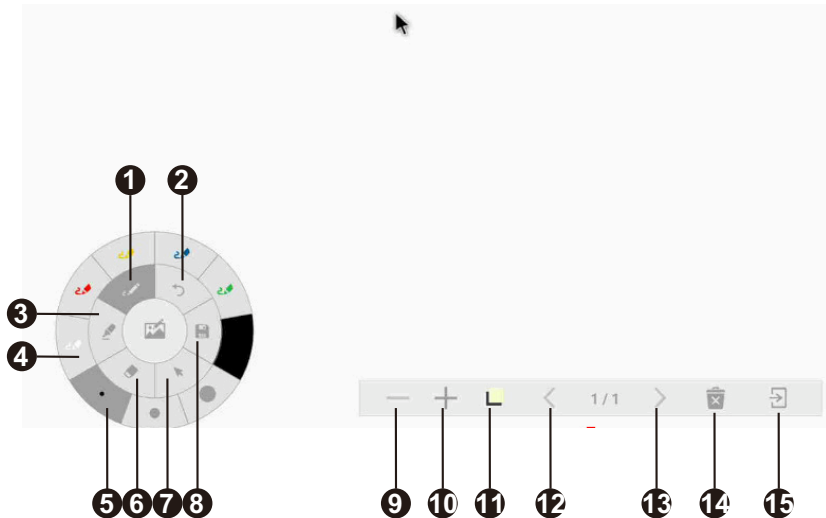

No.	Tool	Task
1	Pencil	Click this icon to select a color and size for the pencil to write or draw on the whiteboard. See <i>Pencil Options</i> , page 23.
2	Undo	Click this icon to undo your current move.
3	Highlighter	Click this icon to select a color and size for the pencil to highlight on the whiteboard. See <i>Highlighter Options</i> , page 23.
4	Color Options	The color options are available when you select pencil or highlighter and the options vary depending on which tool is selected.
5	Size Options	The sizing options are available when you select pencil, highlighter, or eraser and the options vary depending on which tool is selected.

No.	Tool	Task
6	Eraser	Click this icon to select a size for the eraser to remove any pixels on the whiteboard, or select the broom icon to remove all pixels on the whiteboard. See <i>Eraser Options</i> , page 23.
7	Minimize Color and Sizing Option	Click this icon to minimize the color and sizing options.
8	Save	Click this icon to save your current whiteboard to your device or a USB flash drive.
9	Delete a Layer	Click this icon to delete a whiteboard layer.
10	Add a Layer	Click this icon to add a whiteboard layer.
11	Whiteboard Layout Options	Click this icon to select a whiteboard layout. See <i>Whiteboard Layouts</i> , page 24.
12	Previous Layer	Click this icon to go to a previous whiteboard layer.
13	Next Layer	Click this icon to go to a next whiteboard layer.
14	Bin	Click to remove the current whiteboard to the bin. See <i>Removing a Whiteboard Layer</i> , page 24.
15	Go Back	Click this icon to go back to the previous page.

Pencil Options



Highlighter Options



Eraser Options



Save As

To save your current whiteboard to your device or a USB flash drive, click  and the screen below appears. You can save the whiteboard to image or PDF format, USB flash drive or your own device. If you choose to save the whiteboard to **Your device**, the VP2021 will automatically generate a QR code on the bottom right of the screen. Scan the QR code to open the saved file.



Whiteboard Layouts

To select a whiteboard layout, click  and the screen below appears. Click to select a desired whiteboard layout.

Note: This function is only supported by VP2021.



Removing a Whiteboard Layer

To remove the current whiteboard, click  and the screen below appears. Click **OK** to remove the whiteboard without saving.

Note: This function is only supported by VP2021.

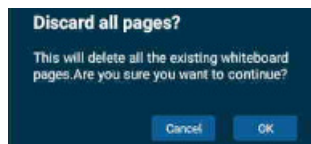

Background Pad

The background pad allows you to draw, make notes, and share to all the participants. You can also save the background pad locally for future use. To use the background pad, click  from the OSD tool menu. The screen below appears, please refer to the screen and table below for the supported functions and its description.

Note: This function is only supported by VP2021.

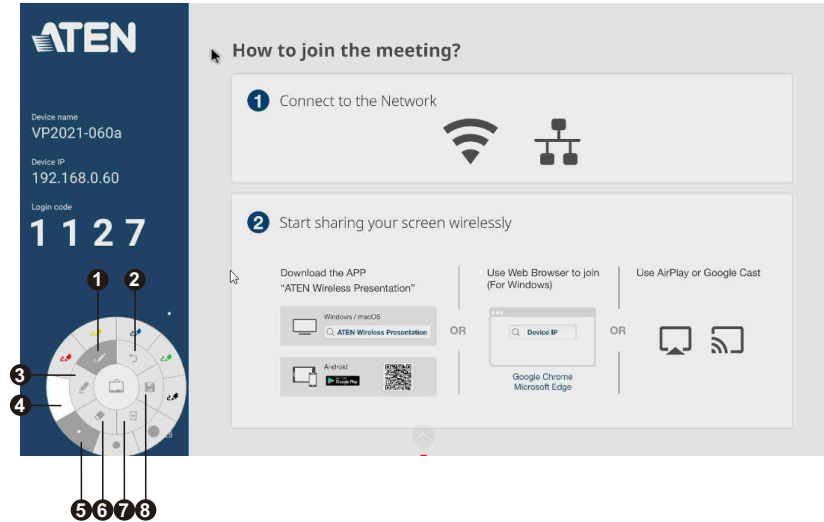

No.	Tool	Task
1	Pencil	Click this icon to select a color and size for the pencil to write or draw on the whiteboard. See <i>Pencil Options</i> , page 23.
2	Undo	Click this icon to undo your current move.
3	Highlighter	Click this icon to select a color and size for the pencil to highlight on the whiteboard. See <i>Highlighter Options</i> , page 23.
4	Color Options	The color options are available when you select pencil or highlighter and the options vary depending on which tool is selected.

No.	Tool	Task
5	Size Options	The sizing options are available when you select pencil, highlighter, or eraser and the options vary depending on which tool is selected.
6	Eraser	Click this icon to select a size for the eraser to remove any pixels on the whiteboard, or select the broom icon to remove all pixels on the whiteboard. See <i>Eraser Options</i> , page 23.
7	Go Back	Click this icon to go back to the previous page.
8	Save	Click this icon to save your current whiteboard to your device or a USB flash drive.

Pencil Options



Highlighter Options



Eraser Options



Save As

To save your current whiteboard to your device or a USB flash drive, click  and the screen below appears. You can save the whiteboard to image or PDF format, USB flash drive or your own device, or you can paste it into whiteboard for discussion. If you choose to save the whiteboard to **Your device**, the VP2021 will automatically generate a QR code on the bottom right of the screen. Scan the QR code to open the saved file.

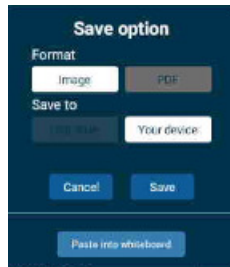

This page is intentionally left blank.

Chapter 4

Remote Operation

Overview

This chapter provides information on how to remotely operate and configure the VP2020 / VP2021 via the web console.

Default Network and Login Settings

The VP2020 / VP2021 uses the following network settings and login credentials as its default settings.

Note: For wired connection users, please configure the IP settings in the *Ethernet Settings*, page 44 via wireless connection. You can either choose DHCP for dynamic IP address or Static to assign an IP address.

- ◆ Default network settings

Network Parameter	Default Setting
IP Address	192.168.0.60
Subnet Mask	255.255.255.0
Gateway	192.168.0.1
HTTP Port	80

Note: If the VP2020 / VP2021 is connected to a router that supports DHCP, a dynamic IP address will be assigned to the VP2020 / VP2021 as soon as it connects to the network. Simply connect an HDMI-enabled or VGA monitor to look up the IP address via the OSD.

- ◆ Default login credentials

Login Credential	Default Setting	Limitations
Username	administrator	5 to 30 characters in length without special characters, not case-sensitive
Password	password	

Supported Web Browsers

The VP2020 / VP2021 supports access to its web console through the following web browsers and operating systems:

Operating System	Web Browser	Supported Version
Windows 10 x64	Edge	85.0.564.67 x64
Windows 10 x64	Firefox	88.0 x64
Windows 10 x 64	Chrome	90.0.4430.93 x64
Ubuntu 20.04 x64	Chrome	90.0.4430.93 x64
Solaris 11.4 x64	Firefox	52.9.0_x32
Windows 10 x64_1703_Enterprise	QQ	10.8
Windows 10 x64_1703_Enterprise	360	13.1.1302.0

Operation Consideration

When using the web console or ATEN Wireless Presentation App, make sure your mobile and laptop / PC is/are connected to the same network environment where the VP2020 / VP2021 is installed.

Browser Sharing

When you log into the VP2020 / VP2021's web console as participant, you are remotely connected to an online meeting where you can share your screen to meeting participants.

Joining a Meeting as Participant via Web Console

When you log into the VP2020 / VP2021's web console as participant, you are allowed to share your laptop / PC, or an application window / Chrome tab from your laptop / PC to the meeting participants.

Note:

- ◆ This feature is only available using Chrome.
- ◆ The VP2020 / VP2021 can receive up to 20 (VP2020: 8; VP2021: 20) concurrent streamed-in channels via LAN and wireless connection and up to 2 concurrent streaming channels via LAN and wireless connection.

-
1. Make sure you have the screen, application window, or the Chrome tab you wish to share opened on your laptop / PC.
 2. In a web browser, type the IP address of the VP2020 / VP2021. This screen appears.

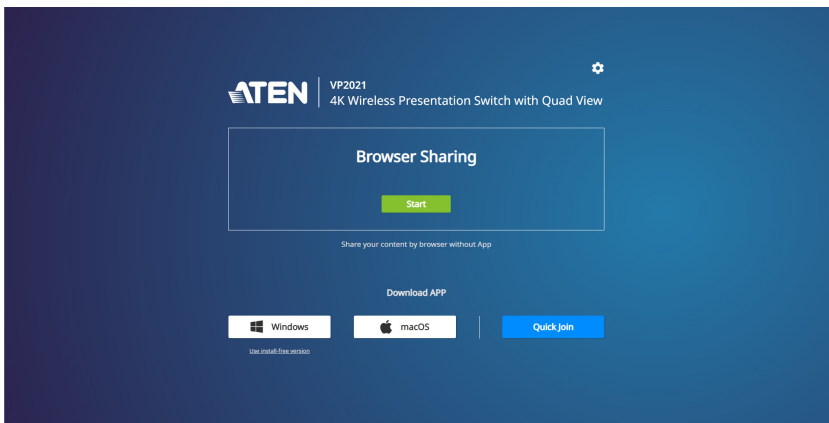

3. Click  to share your screen to the meeting participants and the screen below appears.

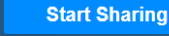
4. Enter a display name and click  .

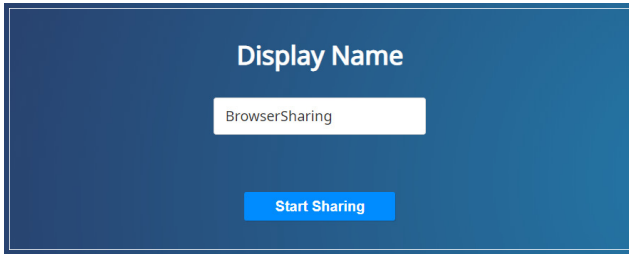

5. The screen below appears. Select a screen to share, to combine and share both the system and your microphone audios, check the **Share system audio** checkbox, and click **Share**.

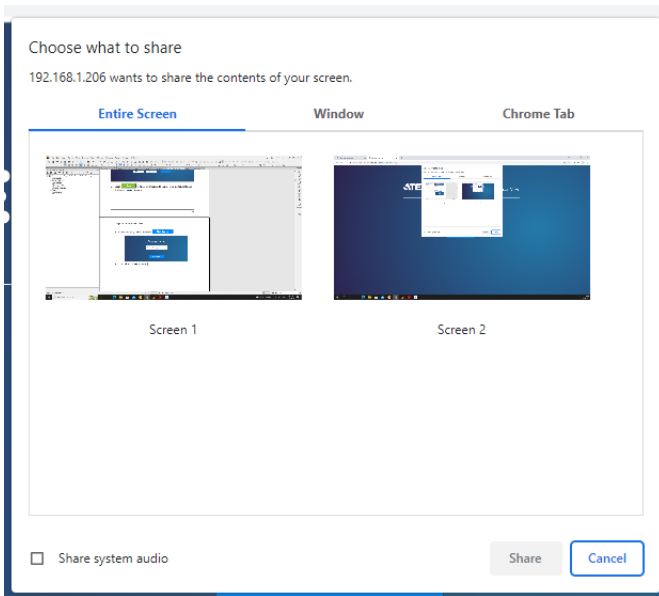

6. The screen below appears when you have successfully shared your screen.

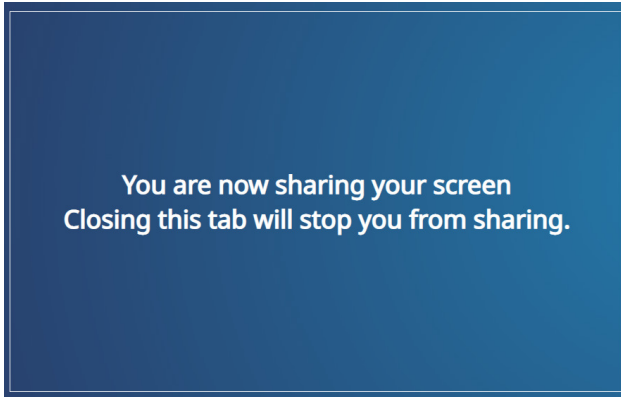

7. To stop the screen sharing, simply close the tab.

Note:

If your Chrome does not have an appropriate extension installed for this feature, a prompt appears for installing an extension when you try to enable the function. In this case, follow the steps below to download and install the extension.

- a. Click **download** in the pop-up prompt.
 - b. Open a new tab in your Chrome and type **chrome://extensions** in the address bar to open the extensions page.
 - c. Enable **Developer mode** at the top-right corner and reload the page.
 - d. Drag-and-drop the downloaded extension file to this page to install the file.
 - e. Close and reopen the tab to refresh your browser.
-

Logging In the Web Console

When you log into the VP2020 / VP2021's web console as administrator, you are allowed to access and make configuration to the VP2020 / VP2021's settings.

1. In a web browser, type the IP address of the VP2020 / VP2021. This screen appears.

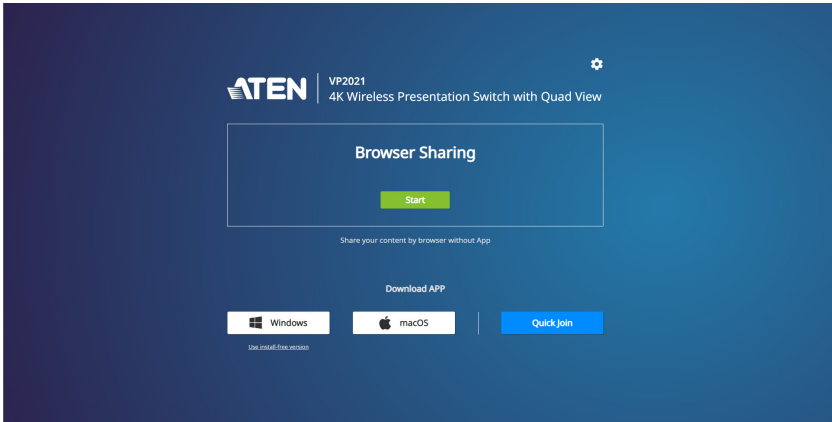

2. Click  to log in as an administrator for system configuration and the screen below appears.

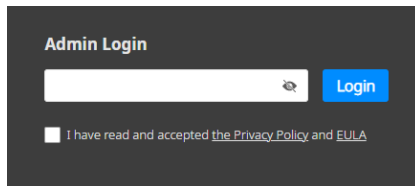

3. Type the password and check the *I have read and accepted the Privacy Policy and EULA* checkbox, then click **Login**.

- If this is the first time you log in as an administrator, you will be asked to change the password for security purpose.

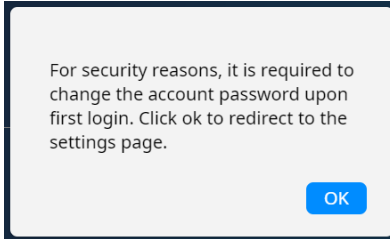

- Click **OK** to change for a new password and the screen below appears.

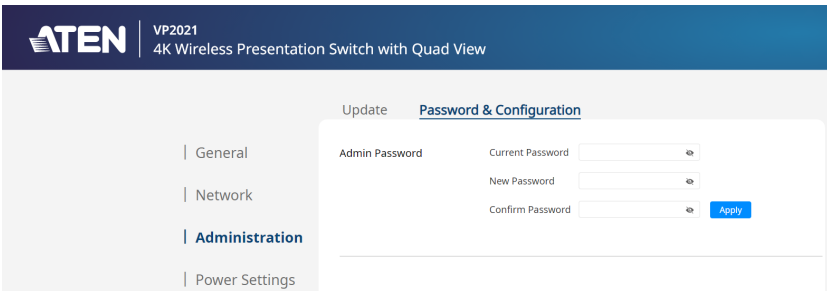

- Fill in the required fields and click **Apply**. The screen below appears and you have successfully changed your password.

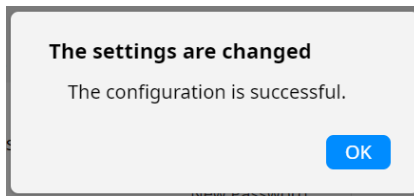

7. You will be brought back to the login page, Click  and enter your new password. Check the *I have read and accepted the Privacy Policy and EULA* checkbox, then click **Login**. The main screen appears.

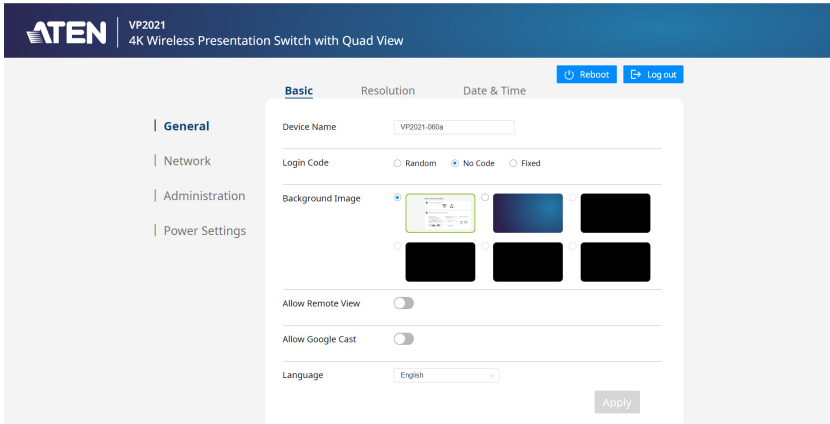

The Web Console Main Screen

The VP2020 / VP2021 defaults to the main screen after logging in. Refer to the illustration and table below for an overview of the web console.

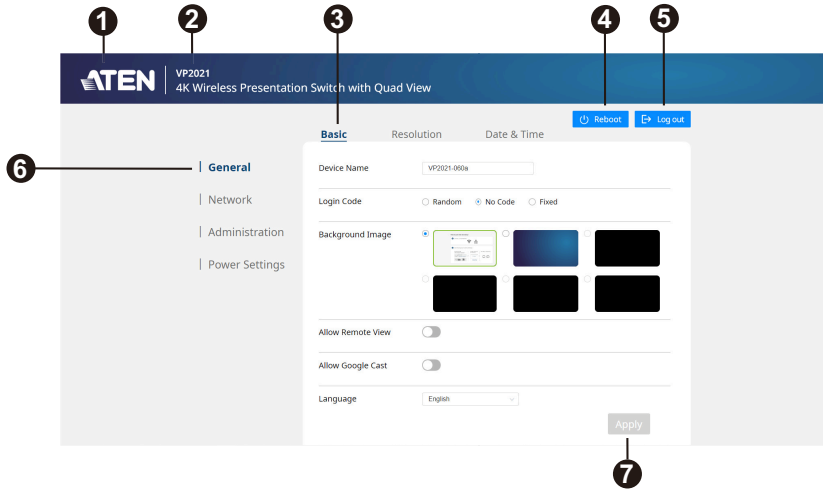

No.	Element	Description
1		Displays the ATEN logo.
2	Device Information	Indicates the device model and name.
3	Sub Settings Tab	Click on the tabs to switch between different sets of settings.
4		Click this icon to reboot the VP2020 / VP2021. Rebooting the device will disconnect all connected participants.
5		Click the icon to log out of the web console.
6	Main Settings Tab	Click on the tabs to switch between different sets of settings.
7		<ul style="list-style-type: none"> ◆ The Apply icon greys out if no configuration is made to the VP2020 / VP2021. ◆ Click the icon to apply all the configuration made to the VP2020 / VP2021.

General Settings

The General page includes settings such as device name, login code, background image, language, resolution settings, and date & time settings. To access the general settings, log in the web console and the screen defaults to the page.

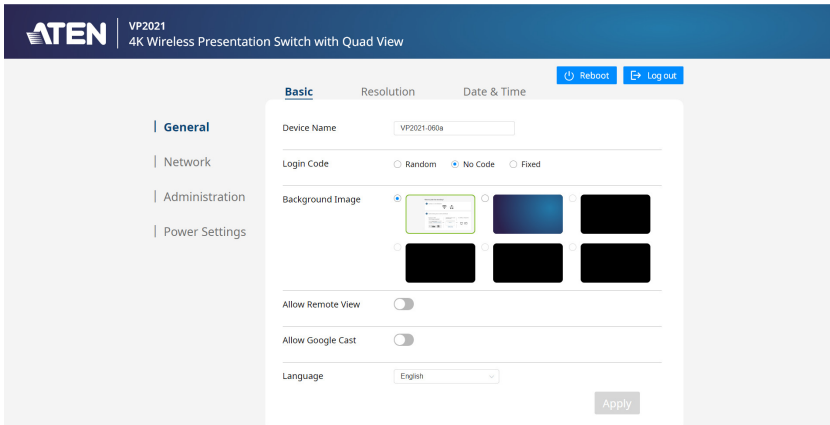

Basic Settings

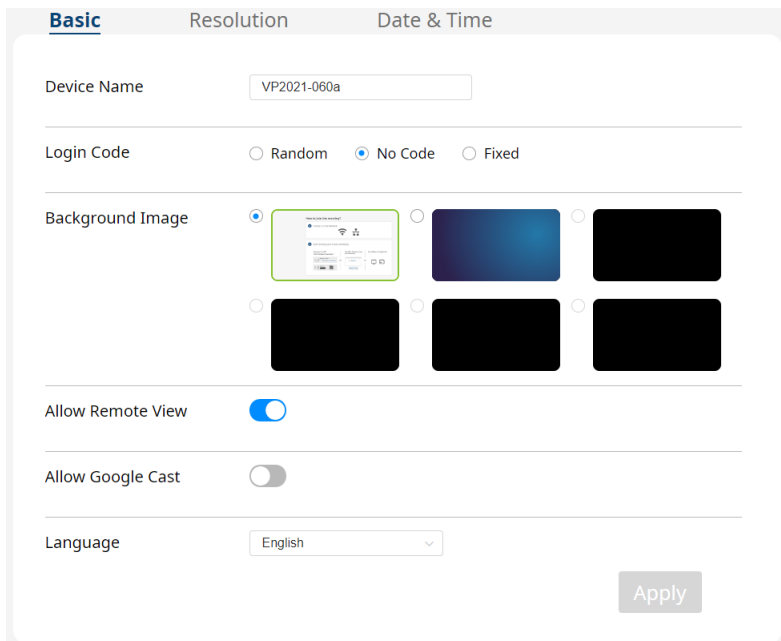

- ◆ **Device Name:** Type a name for the VP2020 / VP2021 WiFi SSID. A valid name should be within 16 characters in length and contains no special characters. This name appears on the Wifi network list on the mobile device and laptop / PC. Changing the device name will disconnect all connected participants.
- ◆ **Login Code:** A login code is a 4-digit combination that is required for participants to join an online meeting.
 - ◆ **Random:** The system generates random login code and displays on the OSD (on-screen display).
 - ◆ **No Code:** No login code is required for the participants to join an online meeting. This is the default setting.
 - ◆ **Fixed:** You can type your combination and the login code is displayed on the OSD (on-screen display)
- ◆ **Background Image:** Selects a background image for the OSD (on-screen display). You can create up to 4 background images by clicking , and then follow the on-screen instructions. The accepted image format and size are as follows, JPEG or PNG formats with a resolution up to 3840 x 2160, and an aspect ration of 16 : 9.



- ◆ **Allow Remote View:** Use the toggle to enable / disable the remote view function. When enabled, the remote view allows users to bring the sharing content onto their mobile and laptop / PC screen for a clear view if they are far away from the main monitors.
- ◆ **Allow Google Cast:** Use the toggle to enable / disable the Google Cast function.

Note: Make sure the VP2020 / VP2021's time setting is identical to the local time zone. To configure the time settings, see *Date & Time Settings*, page 41.

- ◆ **Language:** Use the drop-down list to select a language for your web console and OSD (on-screen display).
- ◆ **Apply:** Click to apply the changes you make to the VP2020 / VP2021.

Resolution Settings

The screenshot shows a settings window with three tabs: 'Basic', 'Resolution', and 'Date & Time'. The 'Resolution' tab is active. It contains the following settings:

- Video Output:** Two radio button options. The first is 'HDMI' (selected with a blue dot), and the second is 'HDMI and VGA (up to FHD)' (unselected).
- Resolution:** A dropdown menu currently showing 'Auto'.
- Output Resolution:** A text field displaying '1920x1080'.

An 'Apply' button is located at the bottom right of the settings area.

- ◆ **Video Output:** Selects an output option between HDMI or HDMI and VGA (up to FHD) for the content and OSD (on-screen display) to be displayed on the display device.
- ◆ **Resolution:** Click the drop-down list to select a resolution for the display device. Changing the resolution will reboot the device. This field is only available when the display is connected to the VP2020 / VP2021. Make sure to select a correct display resolution for the connected display, otherwise the display will not display any content.
- ◆ **Output Resolution:** Indicates the output resolution you set from the above resolution field.
- ◆ **Apply:** Click to apply the changes you make to the VP2020 / VP2021.

Date & Time Settings

Basic Resolution **Date & Time**

Set Time Automatically

24 Hour Format

Time Server

Time Zone

Year/ Month/ Date

Time

Apply

- ◆ **Set Time Automatically:** Use the toggle to enable / disable the set time automatically function. When enabled, the VP2020 / VP2021 sets time automatically. This is the default setting.
- ◆ **24 Hour Format:** Use the toggle to enable / disable the 24 hour format function. When enabled, the VP2020 / VP2021 sets time in a 24 hour format (e.g., 20:30).
- ◆ **Time Server:** Synchronized the VP2020 / VP2021's date and time with a specified NTP server.
- ◆ **Time Zone:** Use the drop-down list to select a time zone.
- ◆ **Year / Month / Date:** Indicates the year, month, and date.
- ◆ **Time:** Indicates the time.
- ◆ **Apply:** Click to apply the changes you make to the VP2020 / VP2021.

Network Settings

The Network page includes settings such as WiFi functionality and its settings, and Ethernet settings such as IP address, subnet mask, and gateway. To access the network settings, log in the web console and then click Network from the main setting tab.

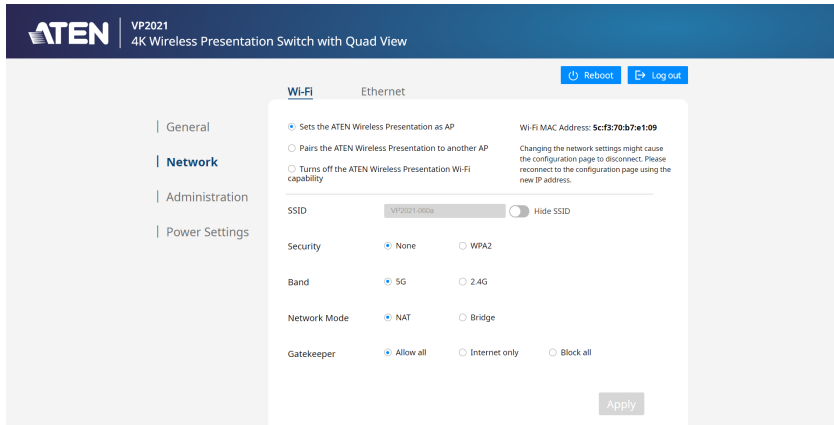

Wi-Fi Settings

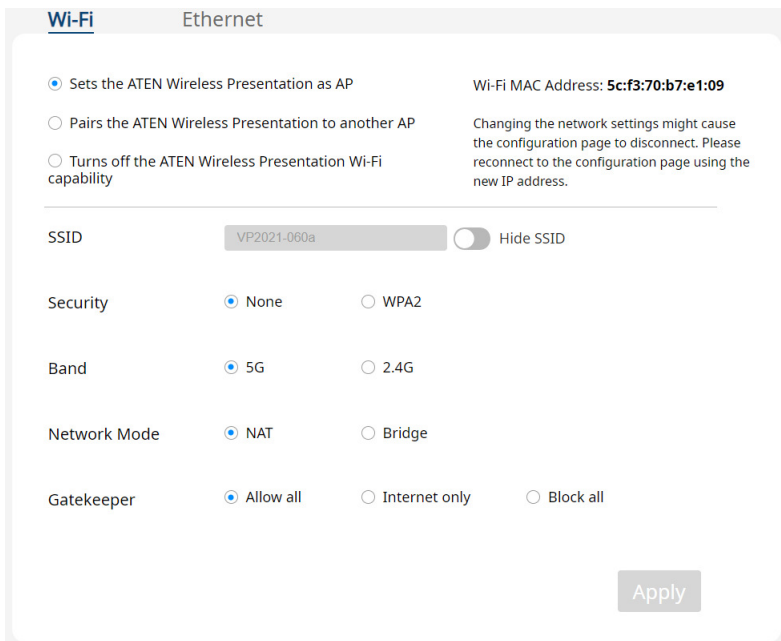

- ◆ **Sets the ATEN Wireless Presentation as AP:** Check this checkbox to set the VP2020 / VP2021 as an access point. This makes the VP2020 / VP2021 able to provide Wi-Fi coverage for participants to connect wirelessly. This is the default setting.
- ◆ **Pairs the ATEN Wireless Presentation to another AP:** Check this checkbox to set the VP2020 / VP2021 as an extender to another access point. This allows users to extend their Wi-Fi coverage.
- ◆ **Turns off the ATEN Wireless Presentation Wi-Fi capability:** Check this checkbox to disable the Wi-Fi function on the VP2020 / VP2021.
- ◆ **SSID:** The Wi-Fi name you see when you scan for an available wireless network. This SSID can be changed via Device Name, see *Device Name*, page 39.
 - ◆ **Hide SSID:** Use the toggle to hide / unhide the SSID.
- ◆ **Security:** Sets the password required for the participants to connect to the VP2020 / VP2021 wirelessly.
 - ◆ **None:** No password is required for the participants to connect to the VP2020 / VP2021 wirelessly. This is the default setting.
 - ◆ **WPA2:** Check this checkbox to set a password for the participants to connect to the VP2020 / VP2021 wirelessly. To see the password you enter, click , click again to hide to password.
- ◆ **Band:** Sets the Wi-Fi bandwidth for the VP2020 / VP2021.
 - ◆ **5G:** Sets the VP2020 / VP2021 to broadcast 5G Wi-Fi bandwidth signals. This bandwidth has higher data rate and smaller Wi-fi coverage. This is the default setting.
 - ◆ **2.4G:** Sets the VP2020 / VP2021 to broadcast 2.4G Wi-Fi bandwidth signals. This bandwidth has lower data rate and larger Wi-Fi coverage.
- ◆ **Network Mode:** Sets the VP2020 / VP2021's network mode.
 - ◆ **NAT:** Sets the VP2020 / VP2021 to NAT network mode. In this mode, the VP2020 / VP2021 allows mapping multiple devices with local private IP addresses to a single public IP address before transferring information. This is the default setting.
 - ◆ **Bridge:** Sets the VP2020 / VP2021 to bridge mode. In this mode, the VP2020 / VP2021 disables the NAT function, which means the VP2020 / VP2021 will not give out any private IP address. The VP2020 / VP2021 itself and the connected participant's IP addresses are given out by a DHCP server-enabled device through an Ethernet connection.
- ◆ **Gatekeeper:** Selects a gatekeeper option for the VP2020 / VP2021.

- ◆ **Allow All:** Check this checkbox to allow all access.
- ◆ **Internet Only:** Check this checkbox to allow Internet access only.
- ◆ **Block All:** Check this checkbox to block all access.
- ◆ **Apply:** Click to apply the changes you make to the VP2020 / VP2021.

Ethernet Settings

Wi-Fi
Ethernet

Obtain IP address

DHCP

Static

IP Address

Subnet Mask

Gateway

DNS 1

DNS 2

Ethernet MAC Address: **dc:4a:9e:70:06:0a**

Changing the network settings might cause the configuration page to disconnect. Please reconnect to the configuration page using the new IP address.

- ◆ **Obtain IP address:** Selects an IP address option for the VP2020 / VP2021.
 - ◆ **DHCP:** Sets the VP2020 / VP2021 to DHCP. In this mode, the connected network switch dynamically assigns an IP address, subnet mask, gateway, and DNS to the VP2020 / VP2021.
 - ◆ **Static:** Sets the VP2020 / VP2021 to static. In this mode, the VP2020 / VP2021 uses a fixed IP address. Specify the IP address, subnet mask, default gateway, and DNS.
- ◆ **IP Address:** Indicates the IP address of the VP2020 / VP2021.
- ◆ **Subnet Mask:** Indicates the subnet mask of the VP2020 / VP2021.
- ◆ **Gateway:** Indicates the gateway of the VP2020 / VP2021.
- ◆ **DNS 1:** Indicates the DNS 1 of the VP2020 / VP2021.
- ◆ **DNS 2:** Indicates the DNS 2 of the VP2020 / VP2021.
- ◆ **Apply:** Click to apply the changes you make to the VP2020 / VP2021.

Administration Settings

The Administration page includes settings such as admin password, device information, firmware upgrades, import / export configuration file, and system reset settings. To access the administration settings, log in the web console and then click Administration from the main setting tab.

Update Settings

Update Password & Configuration

Model Name	VP2021
------------	--------

ATEN Wireless Presentation information	Current Version: 1.0.25(20220916)
--	--------------------------------------

Update Manually	Select Firmware File: <input type="text"/>
-----------------	---

Browse **Update**

- ◆ **Model Name:** Indicates the model name.
- ◆ **ATEN Wireless Presentation Information:** Indicates the ATEN Wireless Presentation App version.
- ◆ **Update Manually:** Upgrades the system firmware to the VP2020 / VP2021.
 - ◆ **Browse:** Click **Browse** to locate an available firmware file.
 - ◆ **Update:** Once a firmware file is selected, click **Update** to upgrade the system firmware to the VP2020 / VP2021.

Password & Configuration Settings

Update
Password & Configuration

Admin Password

Current Password

New Password

Confirm Password

Apply

RESTFUL API Key

Generate

Configuration File

Import Configuration File:

Browse

Import

Export Configuration File

Export

System Reset

All the configurations will be reset to default.
 The system reset will not roll back firmware version.

Reset

System Log Recording

- ◆ **Admin Password:** Changes the admin password here for security purposes. A valid password is not case-sensitive and should be 1 to 16 characters in length, without space or special characters.
 - ◆ **Current Password:** Enters the current password here.
 - ◆ **New Password:** Enters a new password here.
 - ◆ **Confirm Password:** Enters a new password for confirmation here.
- ◆ **RESTFUL API Key**
 - ◆ **Generate:** Click **Generate** to generate a RESTFUL API key.
- ◆ **Configuration File:** Allows users to import / export configuration files.
 - ◆ **Browse:** Click **Browse** to locate an available configuration file.
 - ◆ **Import:** Once a previously exported configuration file is selected, click **Import** to import the selected configuration file to the VP2020 / VP2021.

- ◆ **Export:** Click **Export** to export the current configurations of the VP2020 / VP2021 for future use. This export will not include the username and password settings.
- ◆ **System Reset:** Resets the VP2020 / VP2021 to its default settings.
 - ◆ **Reset:** Click **Reset** to reset the VP2020 / VP2021.
- ◆ **System Log Recording:** Use to toggle to enable / disable the system log recording function. When enabled, the VP2020 / VP2021 records any changes made or activities into system log.
 - ◆ **Download System Log:** Click **Download System Log** to download the system log history.

Power Settings

The Power Settings page includes settings such as sleep mode and suspend mode. To access the power settings, log in the web console and then click Power Settings from the main setting tab.

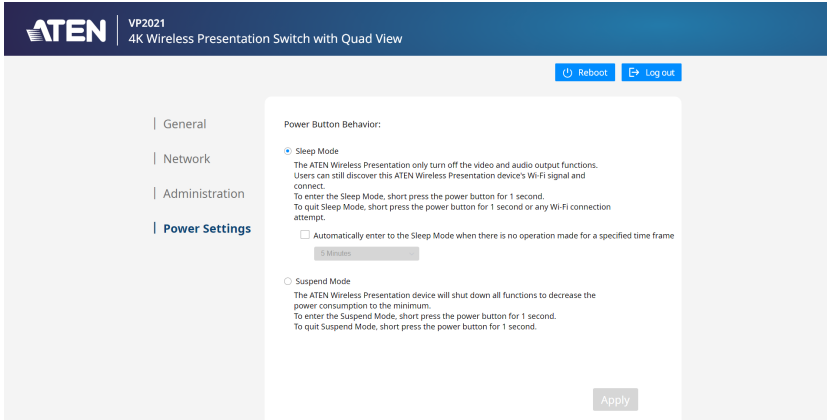

- ◆ **Power Button Behavior:** Selects a power button behavior option for the VP2020 / VP2021.

- ◆ **Sleep Mode:** Check this checkbox to enable sleep mode.

To set a specified time frame for the VP2020 / VP2021 to automatically enter to the sleep mode when there is no operation made, check the **Automatically enter to the Sleep Mode when there is no operation made for a specified time frame** and use the drop-down list to select a time frame option from 5 Minutes / 15 Minutes / 30 Minutes / 60 Minutes.

- ◆ **Suspend Mode:** Check this checkbox to enable suspend mode.

Windows & macOS App Sharing



When you log into the VP2020 / VP2021's web console as participant, you can download the app for Windows or macOS to remotely join an online meeting and share your screen to the meeting participants.

Joining a Meeting as Participant via App

To join an online meeting as participant using the app, follow the steps below.

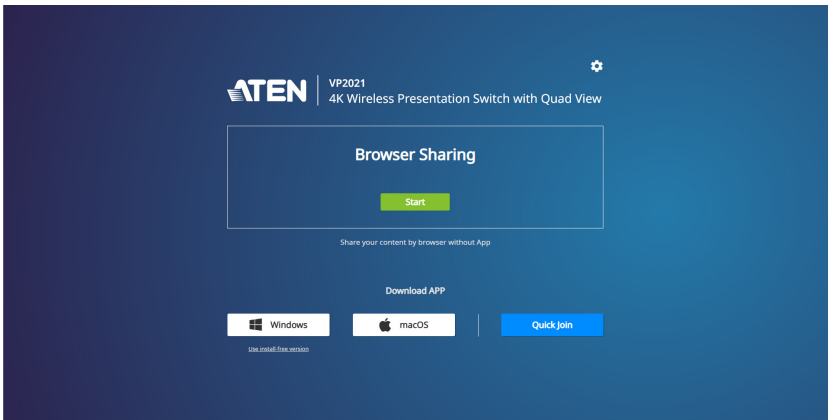
1. In a web browser, type the IP address of the VP2020 / VP2021. This screen appears.

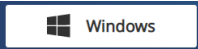

2. Click the app that corresponds to your Laptop / PC's operation system.
 - ◆ Click  if you are using a Windows laptop / PC.
 - ◆ Click  if you are using a macOS laptop / PC.
3. Double-click the downloaded file and follow the on-screen instructions to install the ATEN Wireless Presentation App.

4. When the app is installed on your laptop / PC, click  to open the app and the screen below appears.



5. Wait for a few seconds for the app to scan for an available VP2020 / VP2021 device in the network environment.





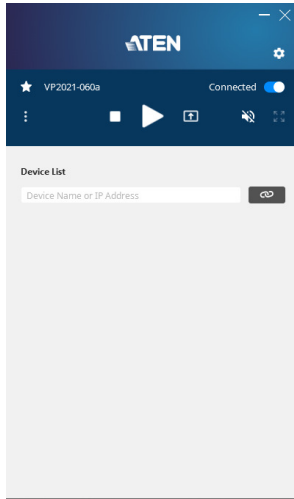





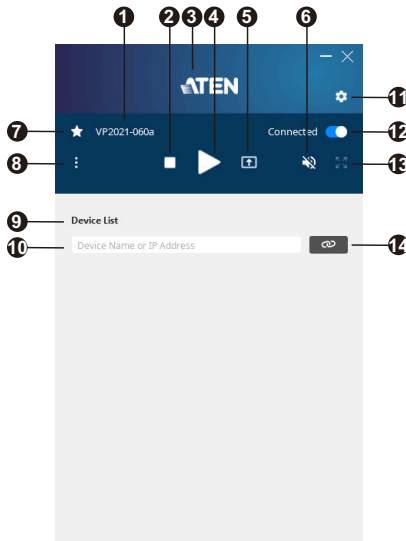



6. To connect an available VP2020 / VP2021 device, click  beside the available VP2020 / VP2021 device, and the screen below appears.



The App Main Screen

The VP2020 / VP2021 defaults to the main screen after connecting to an available VP2020 / VP2021 device. Refer to the illustration and table below for an overview of the ATEN Wireless Presentation App.





No.	Element	Description
1	Device Information	Indicates the device model and name (SSID).
2		Click this icon to stop the screen sharing.
3		Displays the ATEN logo.
4		Click this icon to start / pause the screen sharing.
5		Click this icon to select a screen or app window to be shared to the participants. See , page 58.
6		Click this icon to mute / unmute the audio.
7		Click this icon to make the connected VP2020 / VP2021 device as your favorite, and the icon lights orange.
8		Click this icon to use the remote view function (page 39). See <i>Remote View</i> , page 53. This function is only supported by VP2021.
9	Device List	The available VP2020 / VP2021 device shows here.
10	Device Name or IP Address	Manually type in the VP2020 / VP2021 device name or its IP address here.
11		Click this icon for more app settings. See <i>More App Settings</i> , page 54.
12		Click this icon to disconnect with the VP2020 / VP2021 device. The status changes to indicate the current status of your app from Connected, Sharing, and Paused.
13		Click this icon to display multiple shared content on your screen or monitors.
14		Click this icon to connect with a specified device name or IP address. This icon lights blue when the Device Name or IP Address field is filled.

Selecting Screen or Tab

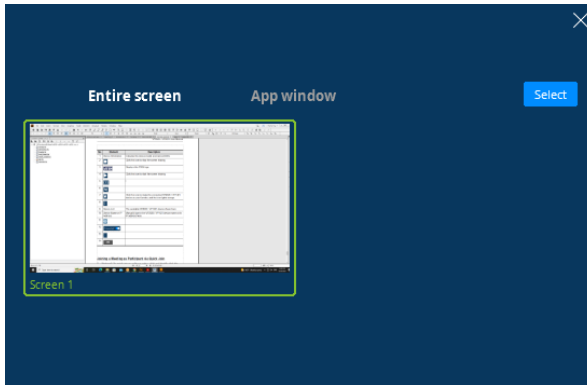
To select a screen or app window from your laptop / PC to be shared to the participants, click  and the screen below appears. Choose the content you wish to share and click **Select**, the selected content is automatically shared to the participants.



Remote View

To bring the sharing content onto your mobile and laptop / PC screen for a clear view if you are far away from the main monitors. Click , the screen below appears and then click . Make sure the remote view function is enabled for this icon to become available. See *Allow Remote View*, page 39.

Note: This function is only supported by VP2021.

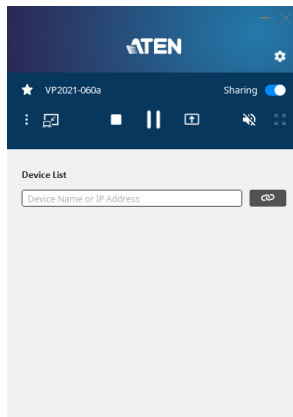

More App Settings

For more ATEN Wireless Presentation App settings, click  and the screen below appears.

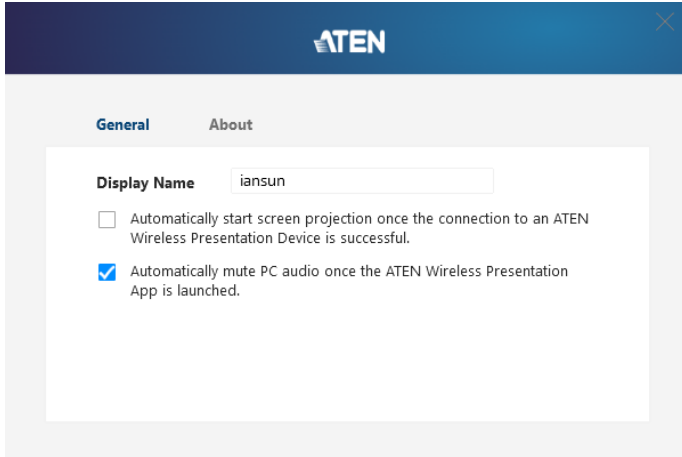

General

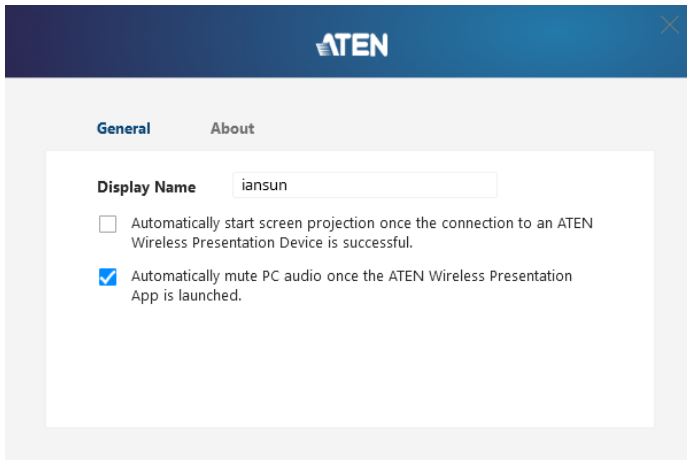

- ◆ **Display Name:**
- ◆ **Automatically start screen projection once the connection to an ATEN Wireless Presentation Device is successful:**
- ◆ **Automatically mute PC audio once the ATEN Wireless Presentation App is launched:**

About

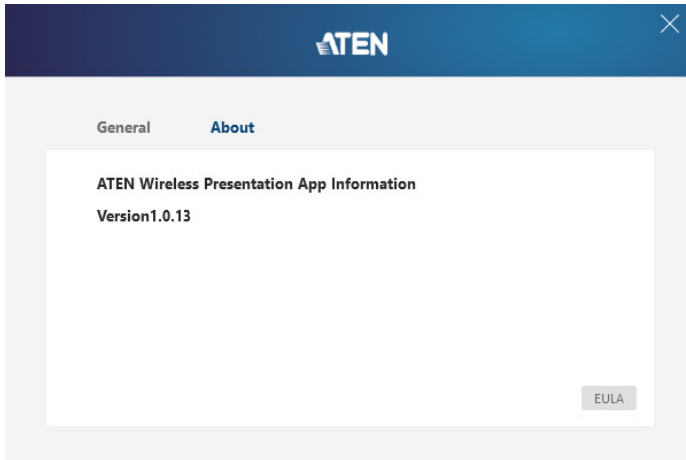

- ◆ **About:** Shows app information and version.

Joining a Meeting as Participant via Quick Join

To quickly join an online meeting, follow the steps below.

1. Click  from the VP2020 / VP2021 web console login page.

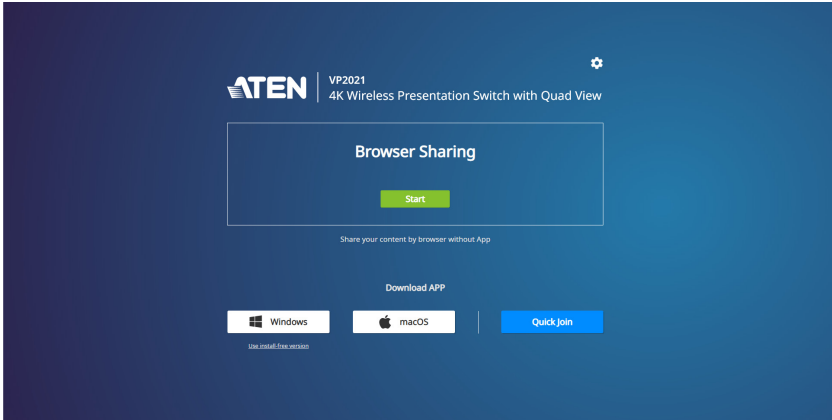

2. Double-click the download file and the ATEN Wireless Presentation App pops up. You are automatically joined to an online meeting.

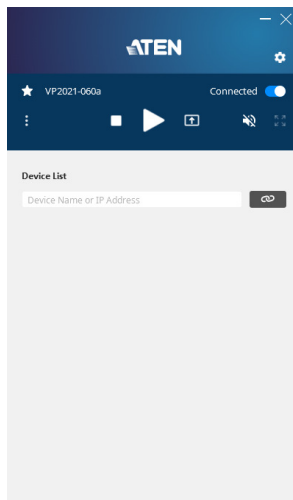

Joining a Meeting as Participant via Install-Free Version

To use an install-free version ATEN Wireless Presentation App, follow the steps below.

1. Click [Use install-free version](#) from the VP2020 / VP2021 web console login page.

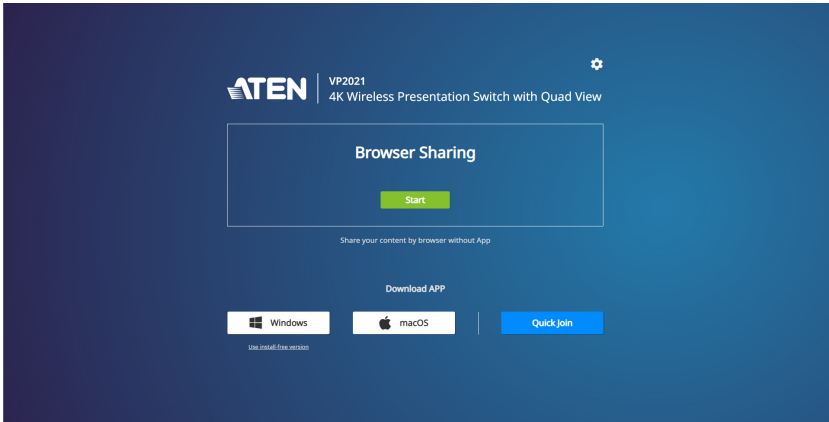

2. Double-click the download file and the ATEN Wireless Presentation App pops up.

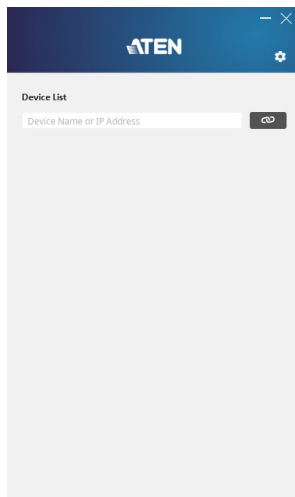

3. Wait for a few seconds for the app the scan for an available VP2020 / VP2021 device in the network environment.

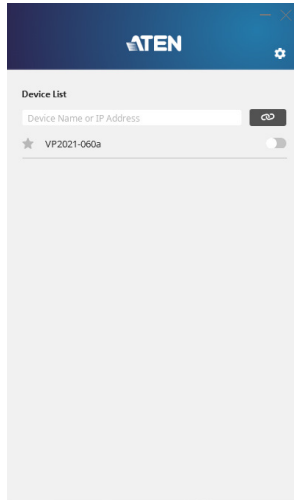

4. To connect an available VP2020 / VP2021 device, click  beside the available VP2020 / VP2021 device, and the screen below appears.

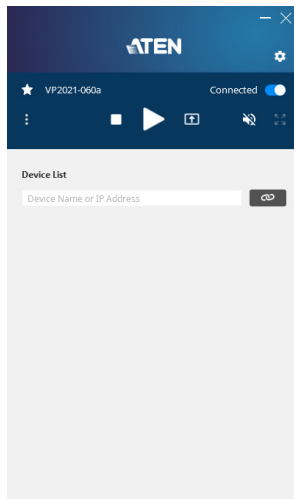

iOS Screen Sharing via AirPlay

For iOS devices such as iPhone and iPad, you can share your screen to the meeting participants via AirPlay. To share your screen, follow the steps below.

1. Go to **Settings > Wi-Fi >** and select an available network (SSID) that is broadcasted from the VP2020 / VP2021. See *Wi-Fi Settings*, page 42.
2. Enter the password to connect to the network.
3. From your iOS devices, enable AirPlay to share your screen to the meeting participants.

This Page Intentionally Left Blank

Chapter 5

Wireless Presentation App

Overview

The ATEN Wireless Presentation App is designed to help you conveniently joining a meeting and share contents on your VP2020 / VP2021 device.

Operation Consideration

When using the web console or ATEN Wireless Presentation App, make sure your mobile and laptop / PC is/are connected to the same network environment where the VP2020 / VP2021 is installed.

Supported Systems

The ATEN Wireless Presentation App supports the following mobile operating systems:

Mobile Operating System	Supported Versions
Android	version 8.0 or later

Installing and Configuring the App

1. Install the ATEN Wireless Presentation App on a mobile device.
 - a) From the mobile device, tap the **Google Play**  icon.
 - b) In the search box, type “ATEN Wireless Presentation App”.
 - c) Tap **ATEN Wireless Presentation App** and install the app.

Or,

 - d) Scan the QR Code below to install the app.



- From the mobile device, tap the **ATEN Wireless Presentation App** icon



to open the app and the screen below appears.

Note: Make sure to connect the mobile device to the network where the VP2020 / VP2021 is installed.

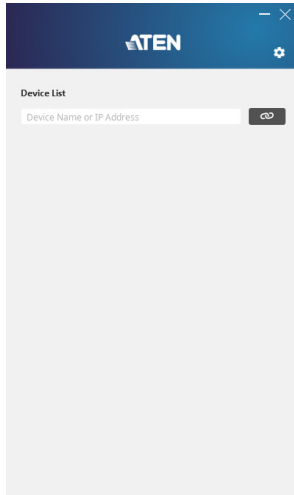

- Wait for a few seconds for the app to scan for an available VP2020 / VP2021 device in the network environment.



4. To connect an available VP2020 / VP2021 device, click  beside the available VP2020 / VP2021 device, and the screen below appears.

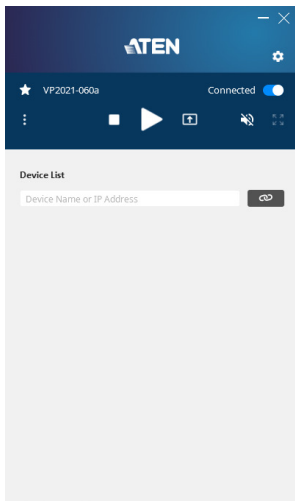







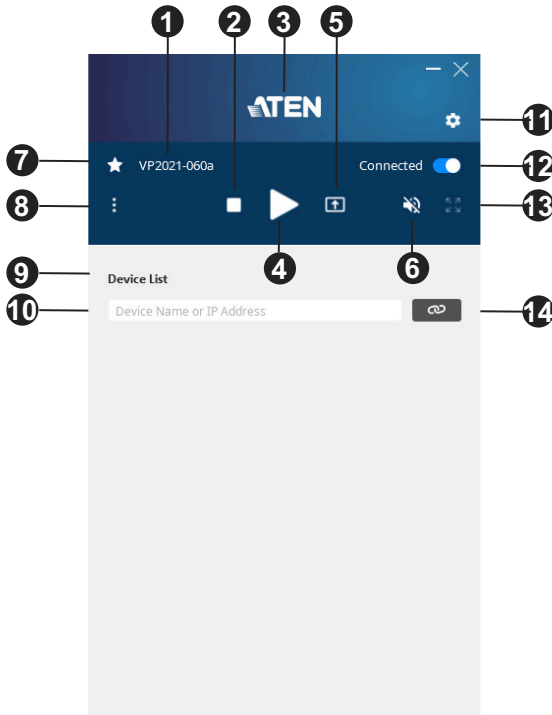



Android Version

Main Page

The VP2020 / VP2021 defaults to the main screen after connecting to an available VP2020 / VP2021 device. Refer to the illustration and table below for an overview of the ATEN Wireless Presentation App.



No.	Element	Description
1	Device Information	Indicates the device model and name (SSID).
2		Click this icon to stop the screen sharing.
3		Displays the ATEN logo.
4		Click this icon to start / pause the screen sharing.

No.	Element	Description
5		Click this icon to select a screen or app window to be shared to the participants. See <i>Selecting Screen or Tab</i> , page 66.
6		Click this icon to mute / unmute the audio.
7		Click this icon to make the connected VP2020 / VP2021 device as your favorite, and the icon lights orange.
8		Click this icon to use the remote view function (page 66). See <i>Remote View</i> , page 66. This function is only supported by VP2021.
9	Device List	The available VP2020 / VP2021 device shows here.
10	Device Name or IP Address	Manually type in the VP2020 / VP2021 device name or its IP address here.
11		Click this icon for more app settings. See <i>More App Settings</i> , page 67.
12		Click this icon to disconnect with the VP2020 / VP2021 device. The status changes to indicate the current status of your app from Connected, Sharing, and Paused.
13		Click this icon to display multiple shared content on your screen or monitors.
14		Click this icon to connect with a specified device name or IP address. This icon lights blue when the Device Name or IP Address field is filled.



Note: Unless otherwise specified, all the screens shown in this manual are for smartphone only. The layout of the actual screens for tablet may vary slightly from these examples.

Selecting Screen or Tab

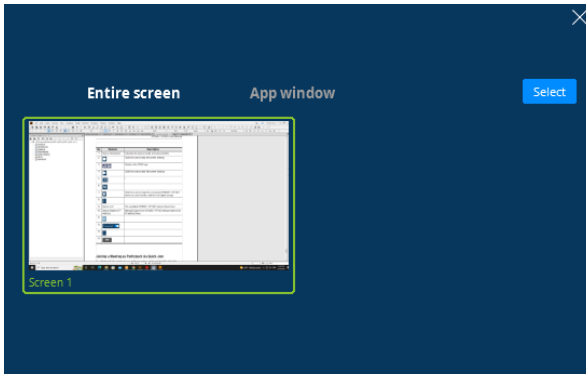
To select a screen or app window from your laptop / PC to be shared to the participants, click  and the screen below appears. Choose the content you wish to share and click **Select**, the selected content is automatically shared to the participants.



Remote View

To bring the sharing content onto your mobile and laptop / PC screen for a clear view if you are far away from the main monitors. Click , the screen below appears and then click . Make sure the remote view function is enabled for this icon to become available. See *Allow Remote View*, page 39.

Note: This function is only supported by VP2021.

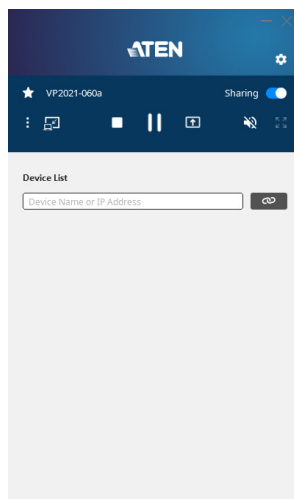

More App Settings

For more ATEN Wireless Presentation App settings, click  and the screen below appears.

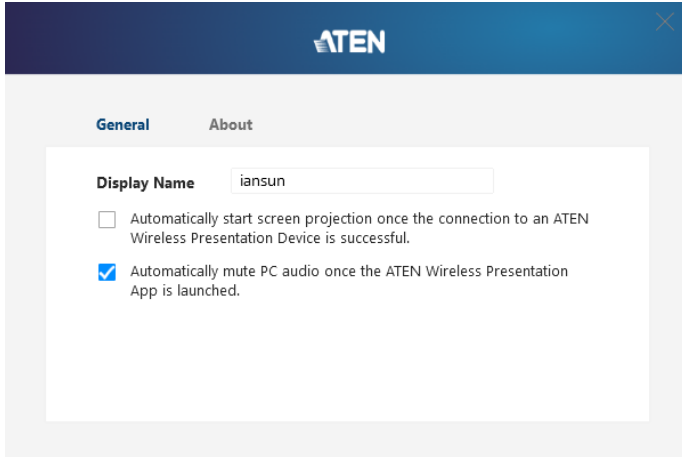

General

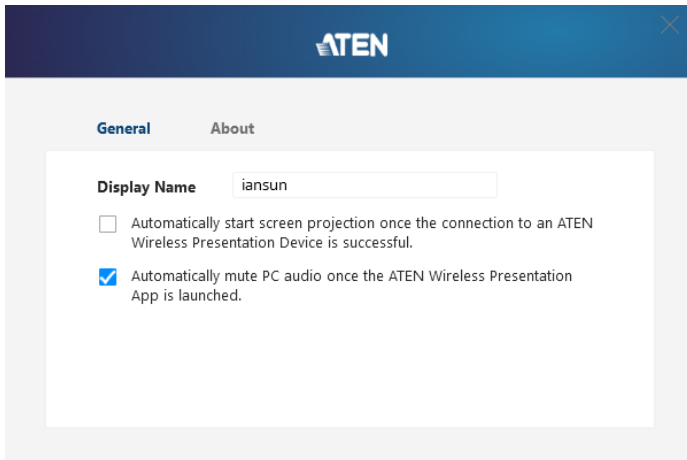

- ◆ **Display Name:**
- ◆ **Automatically start screen projection once the connection to an ATEN Wireless Presentation Device is successful:**
- ◆ **Automatically mute PC audio once the ATEN Wireless Presentation App is launched:**

About

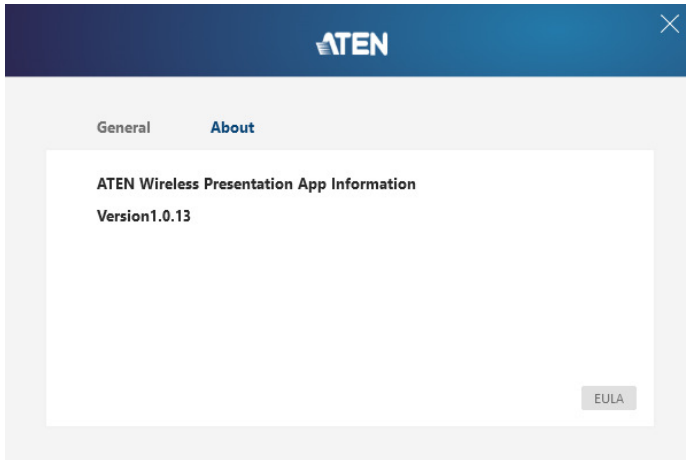

- ◆ **About:** Shows app information and version.

Safety Instructions

General

- ◆ This product is for indoor use only.
- ◆ Read all of these instructions. Save them for future reference.
- ◆ Follow all warnings and instructions marked on the device.
- ◆ Do not place the device on any unstable surface (cart, stand, table, etc.). If the device falls, serious damage will result.
- ◆ Do not use the device near water.
- ◆ Do not place the device near, or over, radiators or heat registers.
- ◆ The device cabinet is provided with slots and openings to allow for adequate ventilation. To ensure reliable operation, and to protect against overheating, these openings must never be blocked or covered.
- ◆ The device should never be placed on a soft surface (bed, sofa, rug, etc.) as this will block its ventilation openings. Likewise, the device should not be placed in a built in enclosure unless adequate ventilation has been provided.
- ◆ Never spill liquid of any kind on the device.
- ◆ Unplug the device from the wall outlet before cleaning. Do not use liquid or aerosol cleaners. Use a damp cloth for cleaning.
- ◆ The device should be operated from the type of power source indicated on the marking label. If you are not sure of the type of power available, consult your dealer or local power company.
- ◆ To prevent damage to your installation it is important that all devices are properly grounded.
- ◆ Do not allow anything to rest on the power cord or cables. Route the power cord and cables so that they cannot be stepped on or tripped over.
- ◆ Position system cables and power cables carefully; Be sure that nothing rests on any cables.
- ◆ Never push objects of any kind into or through cabinet slots. They may touch dangerous voltage points or short out parts resulting in a risk of fire or electrical shock.

- ◆ Do not attempt to service the device yourself. Refer all servicing to qualified service personnel.
- ◆ If the following conditions occur, unplug the device from the wall outlet and bring it to qualified service personnel for repair.
 - ◆ The power cord or plug has become damaged or frayed.
 - ◆ Liquid has been spilled into the device.
 - ◆ The device has been exposed to rain or water.
 - ◆ The device has been dropped, or the cabinet has been damaged.
 - ◆ The device exhibits a distinct change in performance, indicating a need for service.
 - ◆ The device does not operate normally when the operating instructions are followed.
- ◆ Only adjust those controls that are covered in the operating instructions. Improper adjustment of other controls may result in damage that will require extensive work by a qualified technician to repair.

Rack Mounting

- ◆ Before working on the rack, make sure that the stabilizers are secured to the rack, extended to the floor, and that the full weight of the rack rests on the floor. Install front and side stabilizers on a single rack or front stabilizers for joined multiple racks before working on the rack.
- ◆ Always load the rack from the bottom up, and load the heaviest item in the rack first.
- ◆ Make sure that the rack is level and stable before extending a device from the rack.
- ◆ Use caution when pressing the device rail release latches and sliding a device into or out of a rack; the slide rails can pinch your fingers.
- ◆ Do not overload the AC supply branch circuit that provides power to the rack. The total rack load should not exceed 80 percent of the branch circuit rating.
- ◆ Make sure that all equipment used on the rack – including power strips and other electrical connectors – is properly grounded.
- ◆ Ensure that proper airflow is provided to devices in the rack.
- ◆ Ensure that the operating ambient temperature of the rack environment does not exceed the maximum ambient temperature specified for the equipment by the manufacturer.
- ◆ Do not step on or stand on any device when servicing other devices in a rack.

Technical Support

International

- ◆ For online technical support – including troubleshooting, documentation, and software updates: <http://support.aten.com>
- ◆ For telephone support, call this number:

International	886-2-8692-6959
China	86-400-810-0-810
Japan	81-3-5615-5811
Korea	82-2-467-6789
North America	1-888-999-ATEN ext 4988 1-949-428-1111

North America

Email Support		support@aten-usa.com
Online Technical Support	Troubleshooting Documentation Software Updates	http://www.aten-usa.com/support
Telephone Support		1-888-999-ATEN ext 4988

When you contact us, please have the following information ready beforehand:

- ◆ Product model number, serial number, and date of purchase
- ◆ Your computer configuration, including operating system, revision level, expansion cards, and software
- ◆ Any error messages displayed at the time the error occurred
- ◆ The sequence of operations that led up to the error
- ◆ Any other information you feel may be of help

Specifications

VP2020

Video Output	
Interfaces	1 x HDMI Type-A Female (Black) 1 x VGA (HDB-15) Female
Max. Distance	HDMI: Up to 5 m VGA: Up to 15 m
Video	
Max. Resolution	HDMI: Up to 4K @ 30 Hz VGA: Up to 1080p
Audio	
Output	Stereo Audio: 1 x Mini Stereo Jack Female (Black)
Wireless	
Authentication Protocol	AP Mode: WPA2-PSK Station Mode: WEP, WPA, WPA2, 802.1x EAP
Wireless Transmission Protocol	IEEE 802.11ac
Frequency Band	Switchable dual band 2.4GHz and 5GHz (DFS channels not supported)
Reach	20 m Transmission in 5 GHz 30 m Transmission in 2.4 GHz
Connectors	
Console Ports	USB 3.0: 1 x USB Type-A Female (Blue) USB 2.0: 1 x USB Type-A Female USB-C: 1 x USB-C Female
Power	1 x DC Jack (Black)
Switches	
Power	1 x Pushbutton (LED: Blue)
Control	
Ethernet	1 x RJ-45 Female (Silver)
Power Consumption	
Power	DC12V:12WBTU

Environmental	
Operating Temperature	0 - 40°C
Storage Temperature	-20 - 60°C
Humidity	0 - 80% RH, Non-Condensing
Physical Properties	
Housing	Metal
Weight	0.47 kg (1.04 lb)
Dimensions (L x W x H)	17.00 x 10.40 x 2.83 cm (6.69 x 4.09 x 1.11 in)

VP2021

Video Output	
Interfaces	1 x HDMI Type-A Female (Black) 1 x VGA (HDB-15) Female
Max. Distance	HDMI: Up to 5 m VGA: Up to 15 m
Video	
Max. Resolution	HDMI: Up to 4K @ 30 Hz VGA: Up to 1080p
Audio	
Output	Stereo Audio: 1 x Mini Stereo Jack Female (Black)
Wireless	
Authentication Protocol	AP Mode: WPA2-PSK Station Mode: WEP, WPA, WPA2, 802.1x EAP
Wireless Transmission Protocol	IEEE 802.11ac
Frequency Band	Switchable dual band 2.4GHz and 5GHz (DFS channels not supported)
Reach	20m Transmission in 5GHz 30 m Transmission in 2.4 GHz
Connectors	

Console Ports	USB 3.0: 1 x USB Type-A Female (Blue) USB 2.0: 1 x USB Type-A Female USB-C: 1 x USB-C Female
Power	1 x DC Jack (Black)
Switches	
Power	1 x Pushbutton (LED: Blue)
Control	
Ethernet	1 x RJ-45 Female (Silver)
Power Consumption	
Power	DC12V:12WBTU
Environmental	
Operating Temperature	0 - 40°C
Storage Temperature	-20 - 60°C
Humidity	0 - 80% RH, Non-Condensing
Physical Properties	
Housing	Metal
Weight	0.47 kg (1.04 lb)
Dimensions (L x W x H)	17.00 x 10.40 x 2.83 cm (6.69 x 4.09 x 1.11 in)

ATEN Standard Warranty Policy

Limited Hardware Warranty

ATEN warrants its hardware in the country of purchase against flaws in materials and workmanship for a Warranty Period of two [2] years (warranty period may vary in certain regions/countries) commencing on the date of original purchase. This warranty period includes the [LCD panel of ATEN LCD KVM switches](#). For UPS products, the device warranty is two [2] years but battery is one [year]. Select products are warranted for an additional year (see [A+ Warranty](#) for further details). Cables and accessories are not covered by the Standard Warranty.

What is covered by the Limited Hardware Warranty

ATEN will provide a repair service, without charge, during the Warranty Period. If a product is defective, ATEN will, at its discretion, have the option to (1) repair said product with new or repaired components, or (2) replace the entire product with an identical product or with a similar product which fulfills the same function as the defective product. Replaced products assume the warranty of the original product for the remaining period or a period of 90 days, whichever is longer. When the products or components are replaced, the replacing articles shall become customer property and the replaced articles shall become the property of ATEN.

To learn more about our warranty policies, please visit our website:
<http://www.aten.com/global/en/legal/policies/warranty-policy/>

© Copyright 2023 ATEN® International Co., Ltd.
Released: 2023-06-14

ATEN and the ATEN logo are registered trademarks of ATEN International Co., Ltd. All rights reserved. All other brand names and trademarks are the registered property of their respective owners.