



- 6 self-powered inputs for connecting sensors
- Connection via MxBus (two-wire) up to 100 m/110 yd
- Signal input lines up to 50 m/55 yd

Weatherproof Signal Inputs MOBOTIX Devices



Connection of external sensors to MOBOTIX cameras via MxBus

Connection of Sensors (Examples)

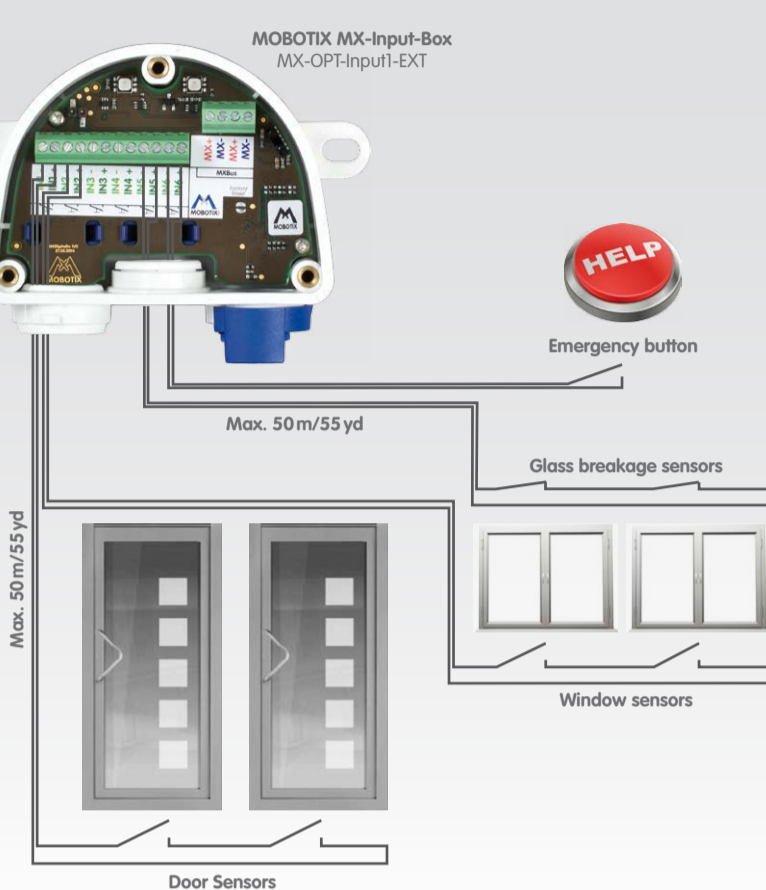

Connection to Camera via MxBus

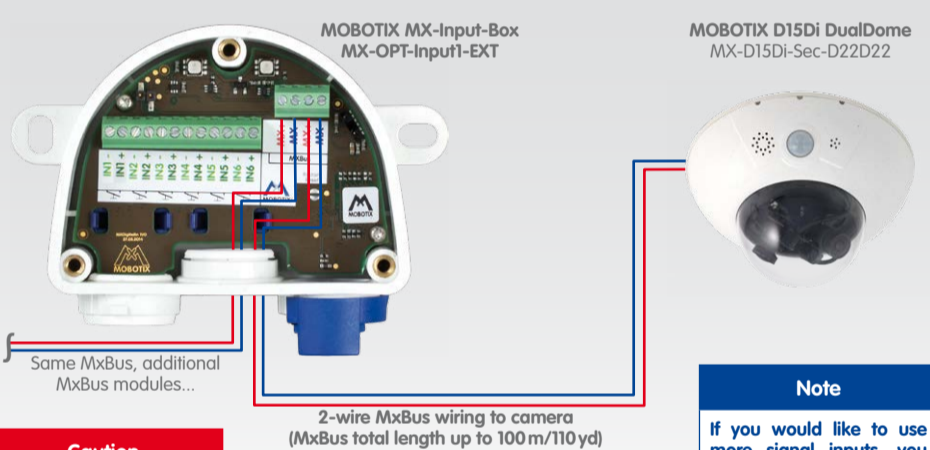

Caution

One MxBus must not be connected to more than one camera!

Note

If you would like to use more signal inputs, you can attach more than one MX-Input-Box module (max. of seven MxBus modules on one MxBus).

Installation Instructions

1. Attach the box

Attach the MX-Input-Box at the mounting position with the cable ports pointing downwards (torque 0.4 Nm). Next, remove the box cover (three screws).

2. Establish connection to the camera

- **Before proceeding, make sure there is no current on the MxBus wires!**
- Cut the MxBus cable to size (2-wire, 0.6 to 0.8 mm diameter). When using **wires without jacket**, strip the insulation of the wires for 5 mm and push the wires through the eight-wire plug (right).
- When using a **cable with jacket**, remove the pre-installed eight-wire plug and insert the appropriate cable plug (3 to 5 mm or 5 to 7 mm). Press the rubber plug into the casing in such a way that the rims stick out equally on both sides. Push the cable through the plug, remove the sheath on a length of 15 mm and strip the insulation of the wires for about 5 mm.
- Connect the MxBus wires to the terminals of the MX-Input-Box using the screwdriver. Make sure the polarity (see sticker in front of the terminal).
- Connect the MxBus wires as described in the corresponding manual to the MOBOTIX camera or to another MxBus module connected to a camera (e.g. KeypadRFID, MX-DoorMaster). Make sure not to exceed the overall length of the MxBus wiring (max. 100 m/110 yd).

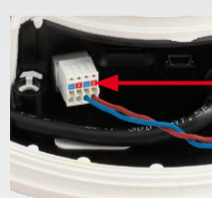
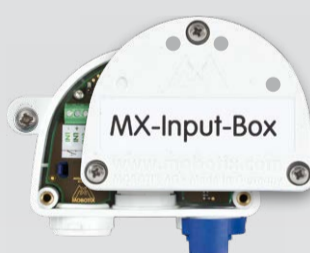

MxBus plug in MOBOTIX D15Di

3. Connect the peripheral devices

Connect the other wires/cables as required and by using the corresponding cable plugs (inputs, MxBus).

4. Lock the cable in place

Insert one or two cable ties depending on the attached cables as shown. Pull the cable ties tightly around the cables in order to provide strain relief.

5. Mount the cover

Mount the cover back onto the MX-Input-Box and tighten it using the cover screws (torque 0.4 Nm).

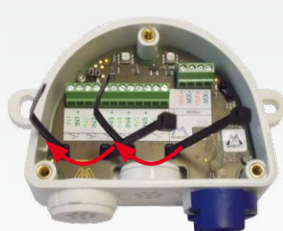

Innovations – Made in Germany

The German company MOBOTIX AG is known as the leading pioneer in network camera technology and its decentralized concept has made high-resolution video systems cost-efficient.

MOBOTIX AG • D-67722 Langmeil • Phone: +49 6302 9816-103 • Fax: +49 6302 9816-190 • sales@mobotix.com

LED Signaling



- LED off
- LED permanently on
- LED flashing

	LED	Meaning
Operation (left)	○	Not connected
	●	Regular operation
	◐	Unencrypted communication
	●	Error during communication
I/O Status (right)	● / ●	As long as one of the signal inputs is closed: Shows status of all 6 inputs one after the other, then pauses for 4 seconds. On closed signal inputs, the LED flashes green once, on open inputs blue once.

Initial Operation of the MX-Input-Box

1. Open the MOBOTIX camera's user interface in the browser

- Enter the IP address of the camera that is connected to the MX-Input-Box in the browser (admin access rights required):
`http://<IP address of camera>`

2. Make sure the camera uses PoE class 3

- Open the **Admin Menu > Ethernet Interface** dialog.
- If **Power Supply** has not been set to **Power over Ethernet (Class 3)**, click on the **Change** link, follow the steps of the wizard and activate **Power over Ethernet (Class 3)**.

3. Activate MX-Input-Box

- Open the **Admin Menu > Manage Hardware Expansions** dialog.
- If the LED icon in the line **MxBus Interface** is not green, click on **Connect**.
- In the **Admin Menu > Manage MxBus Modules** dialog, **Devices** section, **MX-Input-Box** line, click on the **Activate** button.
- If the **Update SW** button appears, click on it to update the software of all connected modules.
- Click on the **MxMessageSystem Configuration** button in the same dialog.
- Click on **Load connected devices from configuration**.
- Click on **Create default configurations for all devices**.

- If required, adjust the settings for individual inputs (e.g. the detection of flanks), then click on **Write configuration** (this will save the configuration).
- In the **MxMessageSystem of MxBus Modules** dialog, click on the **Close** button.

4. Configure events

- Open the **Setup Menu > Event Overview** dialog.
 - In the **Message Events** section, click on **Edit**, then add a new profile and select **MxMessageSystem** as **Event Sensor Type**.
 - Enter a descriptive name for the MxMessageSystem (e.g. "Security-Cameras") and adjust the generated profile name accordingly (e.g. "sc").
 - After storing the settings (click on **Set**), you can use the new events in the **Setup Menu > Action Group Overview** dialog (see the help page for this dialog by clicking on).
- For additional information on the MxMessageSystem, see the help page of this dialog (click on) or on www.mobotix.com > **Support > Media Library > Compact Guides** in the document *Technical Note: MxMessageSystem*.

5. Store the camera configuration

- Save the camera configuration to the local computer (**Admin Menu > Configuration > Save**).
- In the Live screen of the camera, click on **Admin Menu > Configuration > Store**, permanently store the camera configuration and reboot the camera.

Resetting the MX-Input-Box

If the MX-Input-Box had been connected to a different camera before and not deactivated or reset before detaching, the left LED (MxBus status) may flash red after establishing the MxBus connection. In this case, you need to reset the connected and activated MX-Input-Box to **factory defaults**:

- Remove the box cover (three screws).
- Bridge the contact surfaces below the **Factory Reset** label (red circle in figure) using a screw driver, for example (both LEDs are flashing red/blue with increasing frequency).
- Only remove the bridge if both LEDs of the MX-Input-Box are flashing green on/off 3 times to indicate that the process has finished successfully.
- Mount the cover back onto the box (torque 0.4 Nm).
- Set up the MX-Input-Box in the camera (see «Initial Operation of the MX-Input-Box»).

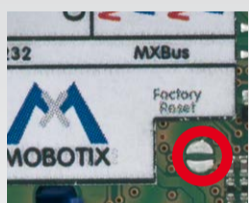

Safety Warnings

- This product must not be used in locations exposed to the dangers of explosion.
- Make sure to install this product as shown in the installation instructions above.
- Electrical systems and equipment may only be installed, modified and maintained by a qualified electrician or under the direction and supervision of a qualified electrician in accordance with the applicable electrical guidelines. Make sure to properly set up all electrical connections.
- The MOBOTIX MX-Input-Box is to be used only for providing signal inputs for MOBOTIX cameras in IP65 environments.
- Make sure that you adhere to all relevant laws, regulations and that you fulfill all certification requirements for the intended use.
- For MOBOTIX cameras with MxBus connector and software version MX-V4.3.0.14 or higher.
- Torque for all screws: 0.4 Nm.
- Press the white cable plug (eight-wire plug or cable plug 3 to 5 mm or 5 to 7 mm) into the casing in such a way that the rims stick out equally on both sides.
- The length of the entire MxBus wiring must not exceed 100 m/110 yd.
- The length of each signal input line must not exceed 50 m/55 yd.
- Diameter of all wires: 0.6 to 0.8 mm (0.8 mm = AWG 21 recommended to reduce line losses).
- The jumper will be used for future versions of the MX-Input-Box and must not be used at present.

Technical Specifications:

Interface to camera	MxBus
Inputs	6 galvanically separated inputs (AC/DC, self-powered, up to 48 V)
Cross-sectional area of wires at the terminals	0.14 mm ² – 0.5 mm ² (AWG 21 – 26)
Protection class	IP65 (DIN EN 60529)
Operating temperature	-30 to +60 °C / -22 to +140 °F (DIN EN 50155)
Power Supply	MxBus
Power Consumption	Typ. 0.5 W

Drilling Template for M15/M25 Wall Mount with MX-Input-Box

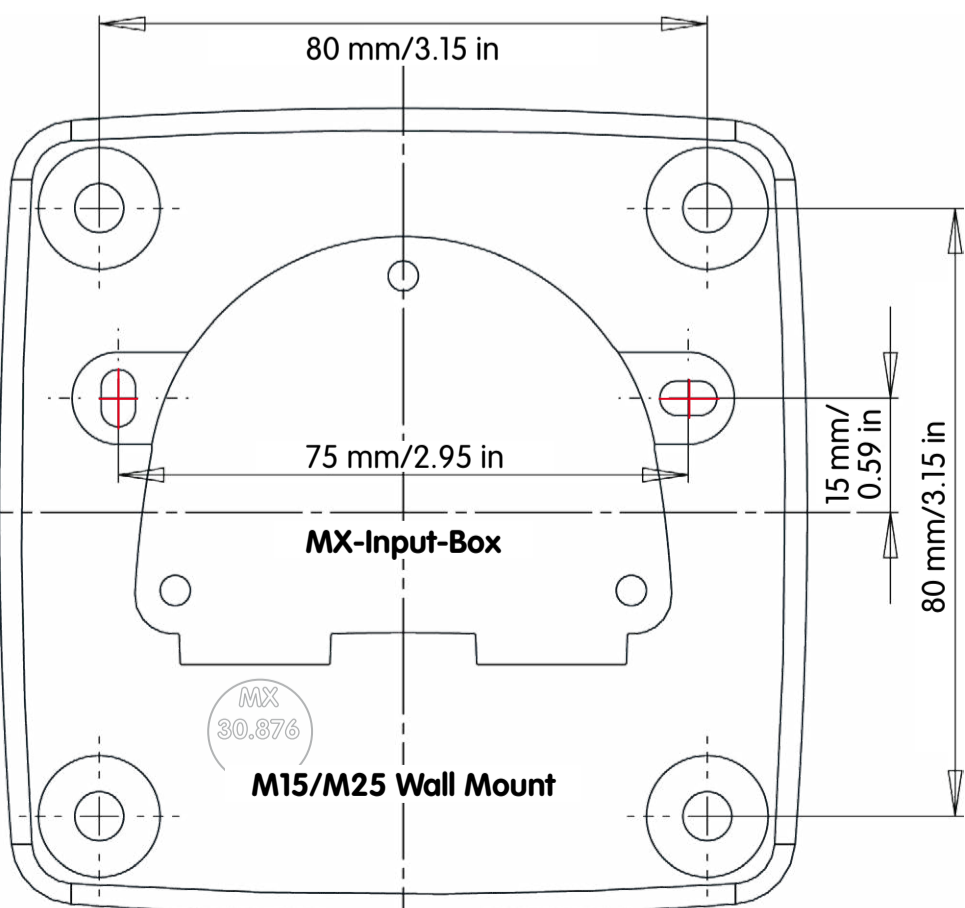

Innovations – Made in Germany

The German company MOBOTIX AG is known as the leading pioneer in network camera technology and its decentralized concept has made high-resolution video systems cost-efficient.

MOBOTIX AG • D-67722 Langmeil • Phone: +49 6302 9816-103 • Fax: +49 6302 9816-190 • sales@mobotix.com